



MMIC SURFACE MOUNT

# Fixed Attenuator

## BAT-12+

50Ω DC to 60 GHz 1.4 W 12 dB

### THE BIG DEAL

- Wideband, DC to 60 GHz
- High Power Handling, 1.4 W
- Excellent Return Loss, Typ. 24 dB
- 1.5x1.5 mm, 6-Lead QFN-Style Package

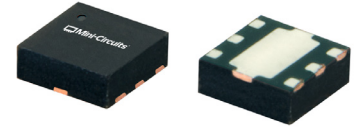

Generic photo used for illustration purposes only

### APPLICATIONS

- Test & Measurement Equipment
- Satellite Communications
- Radar, EW, and ECM Defense Systems
- Telecom Infrastructure
- 5G sub-6 GHz and mmW

### FUNCTIONAL DIAGRAM

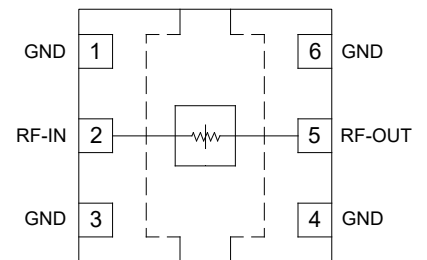

### PRODUCT OVERVIEW

BAT-12+ is a wideband, bidirectional, absorptive fixed attenuator fabricated using a highly reliable and repeatable GaAs semiconductor process. Operating from DC to 60 GHz, this model achieves outstanding attenuation accuracy and flatness while maintaining excellent return loss throughout the entire band. The model can handle input power up to 1.4 W, making it an ideal choice for a wide range of applications such as Test & Measurement, Satellite Communications, Radar, EW, ECM Defense Systems, Telecom Infrastructure, and 5G.

### KEY FEATURES

Features	Advantages
Wideband Operation, DC to 60 GHz	Flat attenuation response from DC to 60 GHz supports a wide array of applications including Test & Measurement Equipment, Satellite Communications, Radar, EW, ECM Defense Systems, & 5G applications.
Excellent Return Loss	Low Return Loss minimizes reflections and enables flexibility to implement anywhere within wideband signal chains.
1.5x1.5 mm 6-Lead QFN-Style Package	Small footprint saves space in dense layouts while providing low inductance and excellent thermal contact to the PCB. Industry-standard packaging allows for ease of assembly in high-volume manufacturing processes.

REV. OR  
ECO-024612  
BAT-12+  
MCL NY  
250221





MMIC SURFACE MOUNT

# Fixed Attenuator

## BAT-12+

50Ω DC to 60 GHz 1.4 W 12 dB

### ELECTRICAL SPECIFICATIONS<sup>1,2</sup> AT +25°C, 50Ω, UNLESS NOTED OTHERWISE

Parameter	Condition (GHz)	Min.	Typ.	Max.	Units
Frequency Range		DC		60	GHz
Attenuation	0.01 - 10	11.5	12.0	12.5	dB
	10 - 20	11.4	11.9	12.6	
	20 - 30	11.1	11.9	12.7	
	30 - 40	10.6	11.6	13.0	
	40 - 50		11.2		
	50 - 60		11.0		
Input Return Loss	0.01 - 10		25		dB
	10 - 20		29		
	20 - 30		24		
	30 - 40		20		
	40 - 50		18		
	50 - 60		17		
Output Return Loss	0.01 - 10		25		dB
	10 - 20		29		
	20 - 30		24		
	30 - 40		20		
	40 - 50		18		
	50 - 60		17		

1. Tested on Mini-Circuits Characterization Test/Evaluation Board TB-BAT-12C+. See Figure 2. Board loss de-embedded to the device.

2. Bi-directional RF-IN and RF-OUT ports can be interchanged.





### TYPICAL PERFORMANCE GRAPHS

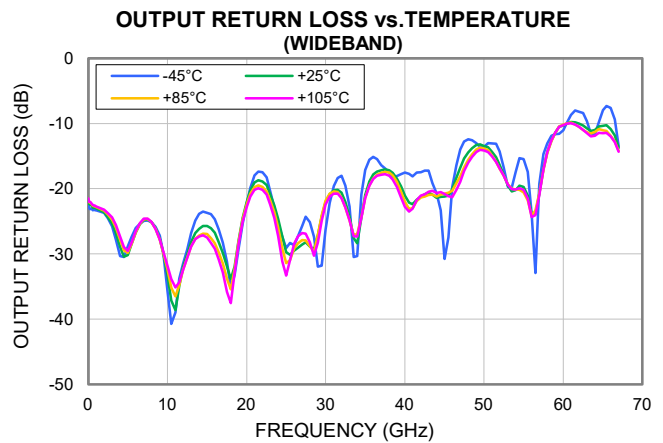
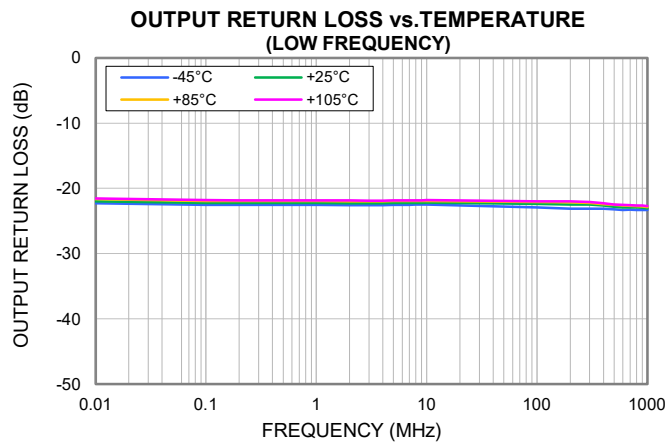
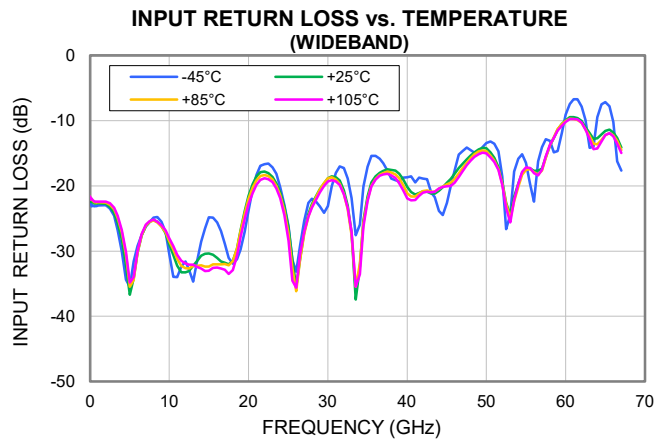
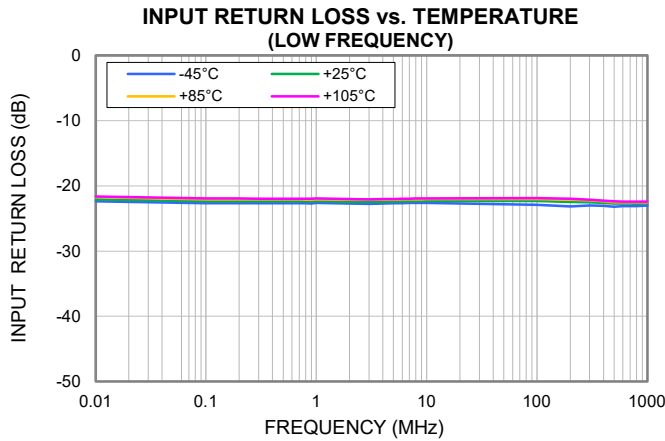
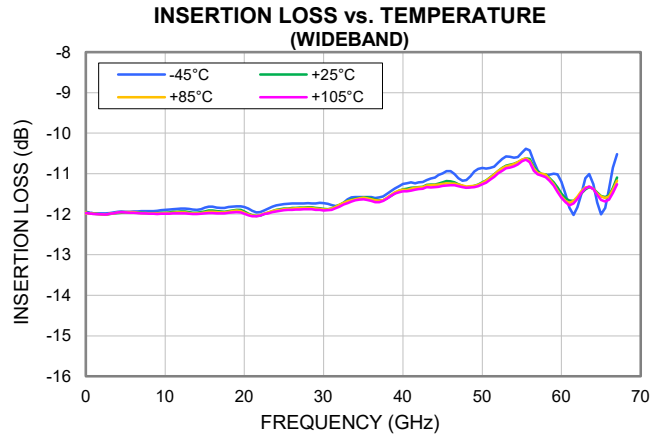
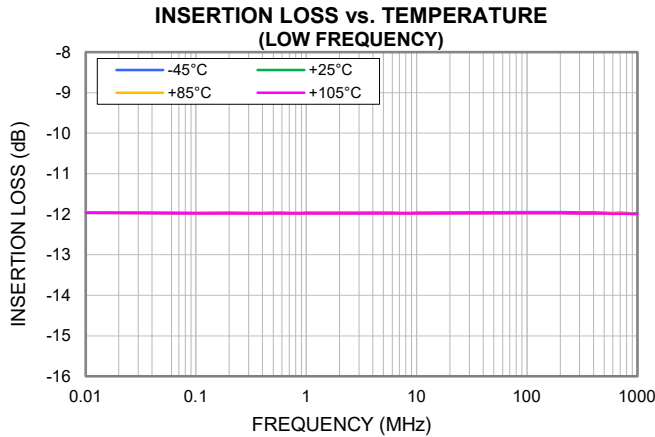



### ABSOLUTE MAXIMUM RATINGS<sup>3</sup>

Parameter	Ratings
Operating Temperature	-45°C to +105°C
Storage Temperature	-65°C to +150°C
RF Input Power <sup>4</sup>	1.4 W

3. Permanent damage may occur if any of these limits are exceeded. Maximum ratings are not intended for continuous normal operation.

4. Power derated to 0.9 W at +105°C.

### ESD RATING

	Class	Voltage Range	Reference Standard
HBM	2	> 2000 V	ANSI/ESD STM 5.1 - 2001
CDM	C3	> 1000 V	ANSI/ESDA/JEDEC JS-002-2022



ESD HANDLING PRECAUTION: This device is designed to be Class 2 for HBM. Static charges may easily produce potentials higher than this with improper handling and can discharge into DUT and damage it. As a preventive measure Industry standard ESD handling precautions should be used at all times to protect the device from ESD damage.

### MSL RATING

Moisture Sensitivity: MSL1 in accordance with IPC/JEDEC J-STD-020E /JEDEC J-STD-033C



### FUNCTIONAL DIAGRAM

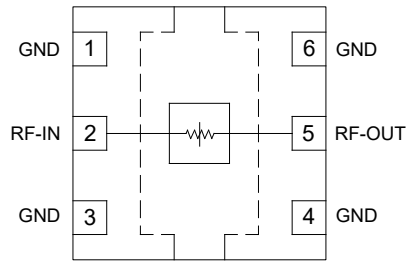

Figure 1. BAT-12+ Functional Diagram

### PAD DESCRIPTION

Function	Pad #	Description (Refer to Figure 2)
RF-IN	2	RF-IN Pad connects to RF Input port.
RF-OUT	5	RF-OUT Pad connects to RF Output port.
GND	1, 3, 4, 6 & Paddle	Connects to ground.

### CHARACTERIZATION TEST BOARD

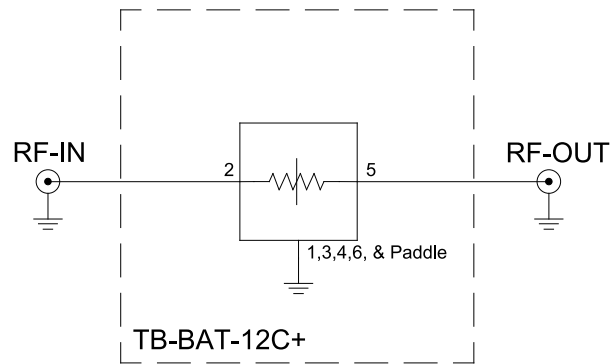

Figure 2. BAT-12+ Characterization and Application Circuit.

#### Electrical Parameters and Conditions

Insertion Loss and Return Loss are measured using N5247B PNA-X microwave network analyzer.

Conditions:

1. Insertion Loss and Return Loss,  $P_{IN} = -5$  dBm



### CASE STYLE DRAWING

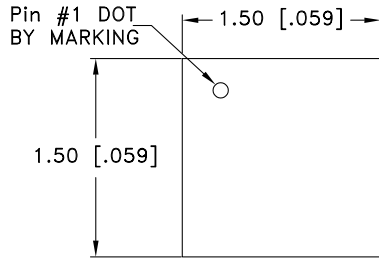

TOP VIEW

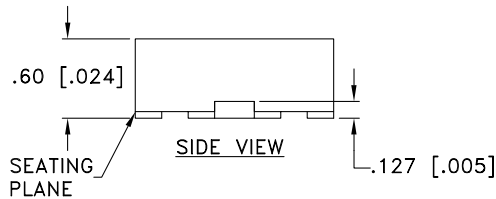

SIDE VIEW

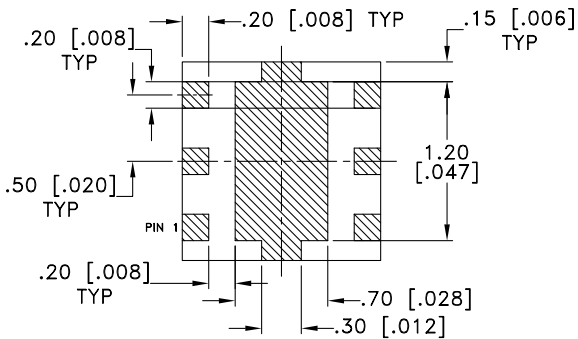

BOTTOM VIEW

### PCB Land Pattern

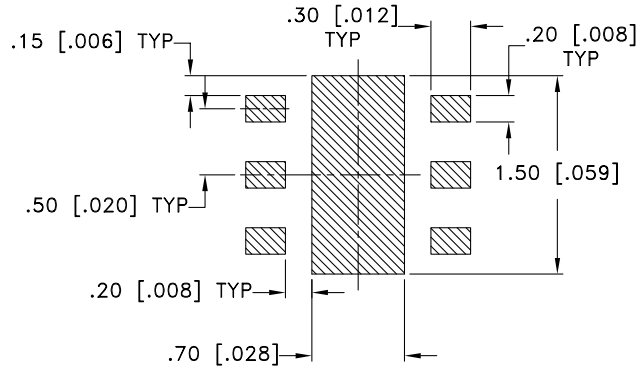

Suggested Layout,  
Tolerance to be within ±0.050 mm

### NOTES:

1. DENOTES METALLIZATION

Weight: .0036 grams

Dimensions are in mm [inches]. Tolerances: 2 Pl.± 0.05 mm

### PRODUCT MARKING

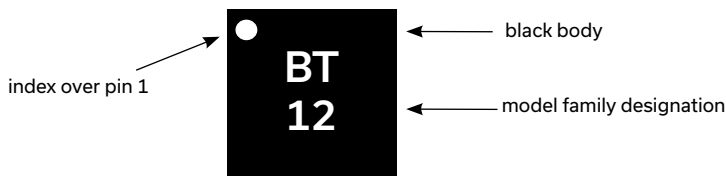

Marking may contain other features or characters for internal lot control



MMIC SURFACE MOUNT

# Fixed Attenuator

## BAT-12+

50Ω DC to 60 GHz 1.4 W 12 dB

ADDITIONAL DETAILED INFORMATION IS AVAILABLE ON OUR DASHBOARD [CLICK HERE](#)

<b>Performance Data</b>	Data Graphs S-Parameter (S2P Files) Data Set (.zip file)
<b>Case Style</b>	KC3009 Plastic package, exposed paddle, lead finish: Nickel-Palladium-Gold
<b>RoHS Status</b>	Compliant
<b>Tape &amp; Reel</b> Standard quantities available on reel	F66 7" reels with 20, 50, 100, 200, 500, 1000, 2000, or 3000 devices
<b>Suggested Layout for PCB Design</b>	PL-801
<b>Evaluation Board</b>	TB-BAT-12C+ Gerber File
<b>Environmental Ratings</b>	ENV08T1

Notes

- A. Performance and quality attributes and conditions not expressly stated in this specification document are intended to be excluded and do not form a part of this specification document.
- B. Electrical specifications and performance data contained in this specification document are based on Mini-Circuits' applicable established test performance criteria and measurement instructions.
- C. The parts covered by this specification document are subject to Mini-Circuits' standard limited warranty and terms and conditions (collectively, "Standard Terms"; Purchasers of this part are entitled to the rights and benefits contained therein. For a full statement of the standard terms and the exclusive rights and remedies thereunder, please visit Mini-Circuits' website at <https://www.minicircuits.com/terms/viewterm.html>



## Typical Performance Data

### Definitions:

Input Return Loss = -S11 (dB)

Attenuation = -S21 (dB)

Output Return Loss = -S22 (dB)

FREQ	Attenuation				Input Return Loss				Output Return Loss			
	-45°C	+25°C	+85°C	+105°C	-45°C	+25°C	+85°C	+105°C	-45°C	+25°C	+85°C	+105°C
(MHz)	(dB)	(dB)	(dB)	(dB)	(dB)	(dB)	(dB)	(dB)	(dB)	(dB)	(dB)	(dB)
0.009	11.96	11.96	11.97	11.97	22.30	22.01	21.71	21.61	22.20	21.90	21.61	21.50
0.5	11.96	11.97	11.98	11.98	22.69	22.38	22.06	21.96	22.54	22.22	21.91	21.81
1	11.96	11.97	11.97	11.98	22.65	22.34	22.04	21.93	22.53	22.22	21.91	21.81
5	11.96	11.97	11.97	11.98	22.70	22.41	22.10	22.00	22.54	22.24	21.93	21.83
10	11.97	11.97	11.98	11.98	22.62	22.33	22.03	21.93	22.49	22.19	21.89	21.79
100	11.94	11.96	11.97	11.97	22.91	22.31	22.03	21.90	22.88	22.34	22.07	21.95
200	11.95	11.96	11.97	11.97	23.18	22.44	22.11	21.96	23.13	22.45	22.15	22.01
400	11.96	11.97	11.97	11.98	23.03	22.64	22.39	22.27	23.10	22.63	22.39	22.28
600	11.97	11.98	11.98	11.99	23.12	22.72	22.53	22.42	23.30	22.89	22.64	22.53
800	11.97	11.99	11.99	11.99	23.12	22.74	22.53	22.44	23.27	22.90	22.71	22.60
1000	11.97	11.99	11.99	12.00	23.00	22.70	22.50	22.41	23.29	23.04	22.84	22.73
2000	11.98	12.00	12.00	12.01	22.95	22.79	22.55	22.40	23.72	23.63	23.37	23.21
4000	11.94	11.97	11.96	11.96	30.06	28.24	27.17	26.77	30.37	28.93	27.82	27.33
6000	11.93	11.95	11.95	11.96	29.23	30.27	30.32	30.07	26.05	26.68	26.69	26.53
8000	11.92	11.97	11.98	11.99	24.87	25.22	25.30	25.20	25.12	25.14	25.14	25.11
10000	11.89	11.96	11.97	11.99	30.34	28.92	28.44	28.01	35.63	33.24	32.38	31.78
12000	11.86	11.93	11.95	11.97	31.63	33.26	32.62	31.89	31.49	31.99	32.41	32.45
14000	11.89	11.96	11.98	12.00	28.58	30.73	32.18	32.66	23.85	26.16	27.21	27.31
16000	11.81	11.91	11.94	11.97	25.61	31.09	32.06	32.55	24.69	26.73	28.34	29.21
18000	11.83	11.93	11.94	11.96	31.92	31.50	31.50	32.90	35.25	33.89	35.44	37.57
20000	11.82	11.94	11.96	11.99	23.81	21.51	21.99	22.82	22.23	22.01	22.34	22.77
22000	11.95	12.03	12.02	12.03	16.70	17.83	18.34	18.86	17.52	18.87	19.74	20.21
24000	11.78	11.90	11.90	11.93	20.23	21.00	21.42	21.89	25.40	24.64	25.97	27.28
26000	11.74	11.85	11.86	11.89	33.16	35.54	36.15	35.62	28.68	29.54	29.15	28.43
28000	11.73	11.83	11.84	11.88	21.97	22.80	23.14	23.34	25.15	28.84	28.79	28.21
30000	11.73	11.87	11.88	11.91	23.14	18.85	18.86	19.34	26.28	22.09	21.83	22.47
32000	11.78	11.77	11.77	11.81	17.31	20.72	21.27	21.30	18.05	20.63	21.39	21.48
34000	11.58	11.62	11.63	11.66	25.92	32.30	31.93	33.56	30.31	28.38	26.97	27.34
36000	11.58	11.61	11.63	11.68	15.42	18.55	18.94	19.04	15.16	17.84	18.43	18.53
38000	11.50	11.61	11.60	11.62	18.91	17.57	17.97	18.40	17.56	17.20	17.56	18.03
40000	11.25	11.38	11.40	11.44	18.72	20.20	21.11	21.93	17.56	21.08	22.04	22.77
42000	11.21	11.33	11.34	11.38	18.88	20.86	20.80	21.03	17.49	21.22	21.36	21.08
44000	11.10	11.27	11.28	11.33	23.84	20.78	20.45	20.41	20.71	21.39	21.21	20.68
46000	10.94	11.19	11.25	11.28	17.67	18.16	18.93	19.51	19.74	20.10	20.32	21.31
48000	11.16	11.34	11.31	11.35	14.50	15.39	15.77	16.16	12.43	14.40	15.58	16.04
50000	10.86	11.21	11.23	11.27	13.43	14.24	14.68	15.01	13.61	13.44	13.83	14.16
52000	10.73	10.93	10.94	10.99	18.56	19.43	19.68	19.89	14.28	16.36	16.95	16.89
54000	10.60	10.76	10.76	10.82	15.85	19.70	20.18	19.72	17.50	20.24	20.14	20.15
56000	10.42	10.64	10.68	10.72	22.41	17.71	17.91	18.06	23.78	23.92	24.14	24.34
58000	11.03	11.02	11.03	11.09	13.11	13.86	13.82	13.69	13.10	14.39	14.54	14.39
60000	11.20	11.48	11.56	11.59	9.08	9.98	10.07	10.25	11.05	10.30	10.18	10.25
62000	11.83	11.60	11.57	11.62	7.87	10.07	10.38	10.32	8.20	10.07	10.53	10.55
64000	11.26	11.37	11.37	11.38	9.48	12.74	13.64	14.31	11.66	11.01	11.32	11.88
66000	11.37	11.54	11.56	11.64	10.18	11.85	12.29	12.43	7.62	10.83	11.87	12.02
67000	10.52	11.09	11.17	11.26	17.68	14.14	14.50	14.98	13.52	13.77	14.19	14.31



## Typical Performance Curves

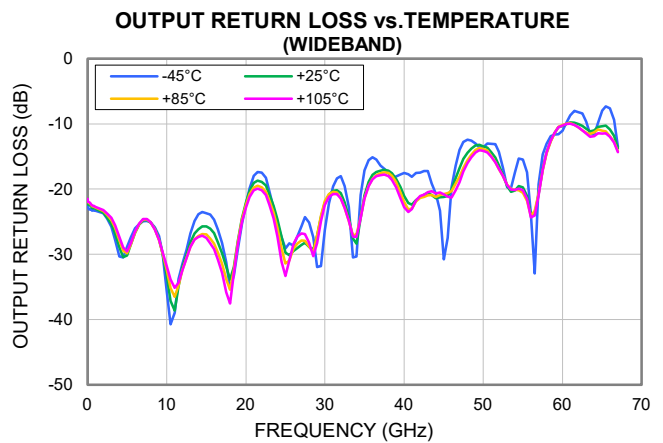
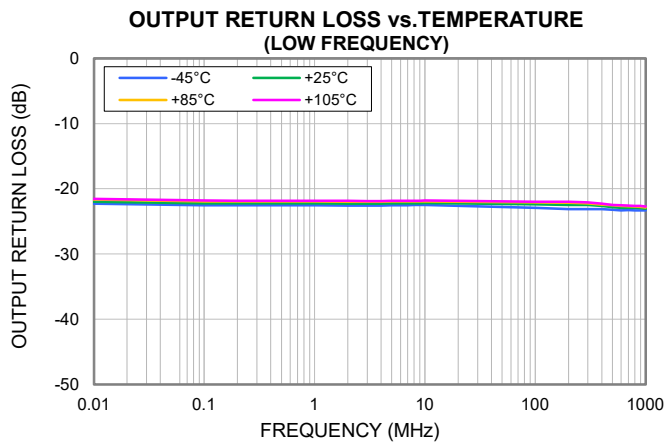
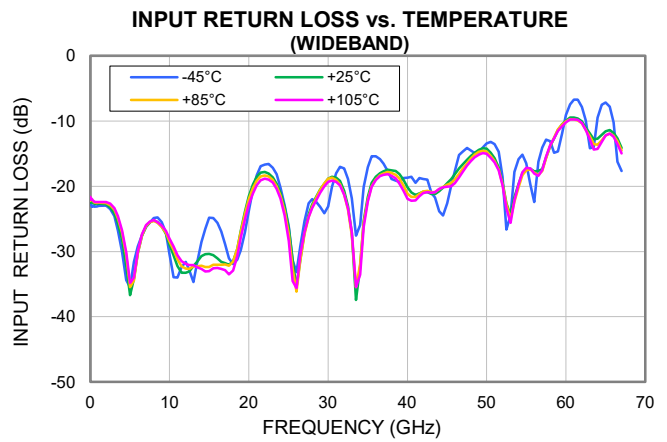
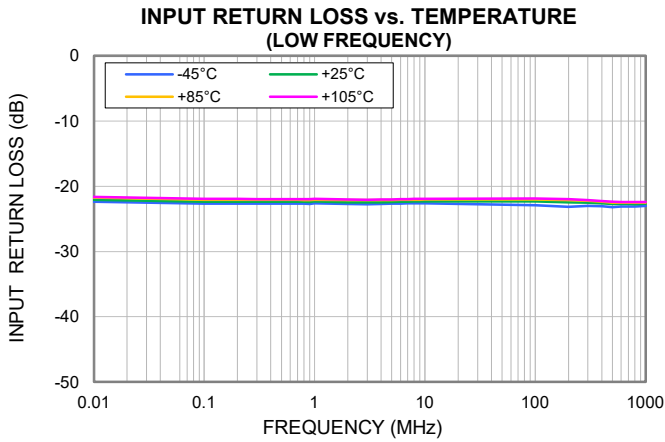
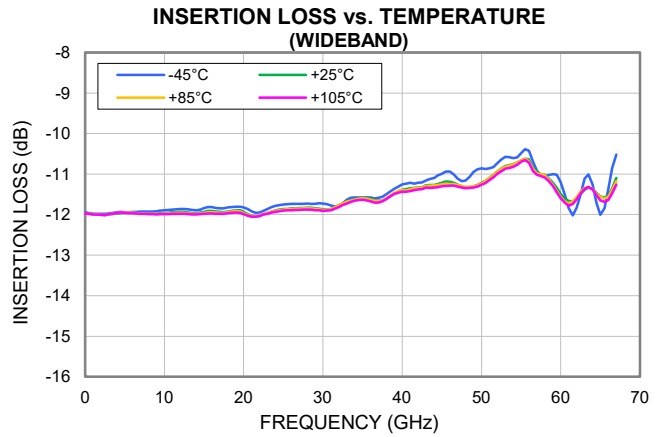
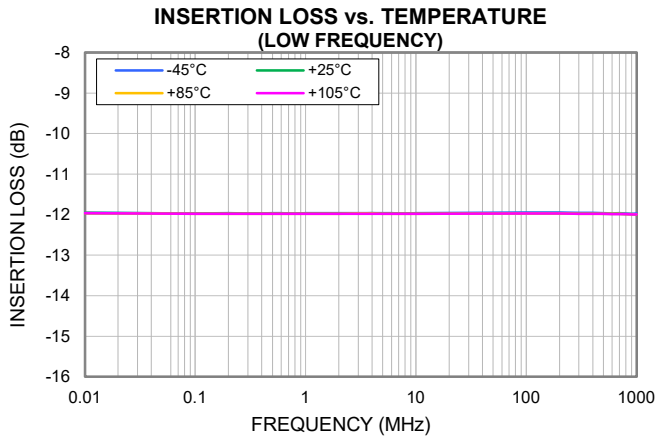

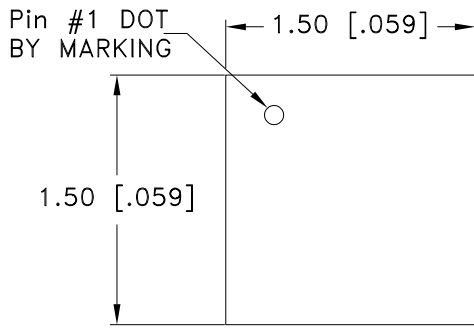

TOP VIEW

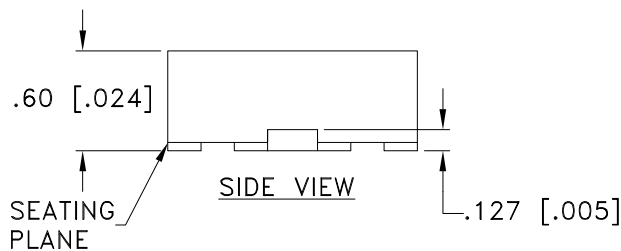

SIDE VIEW

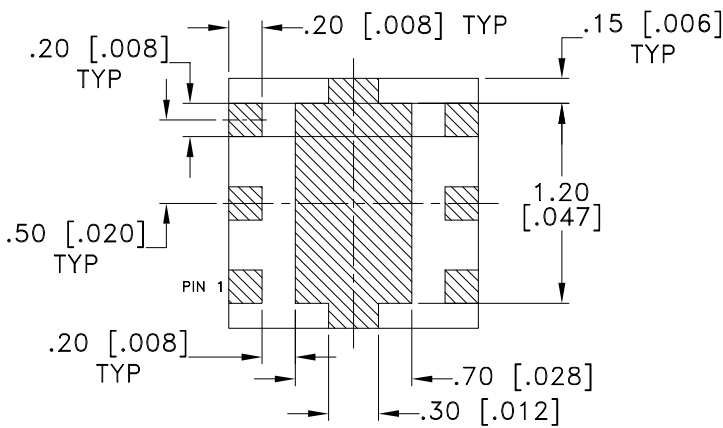

BOTTOM VIEW

PCB Land Pattern

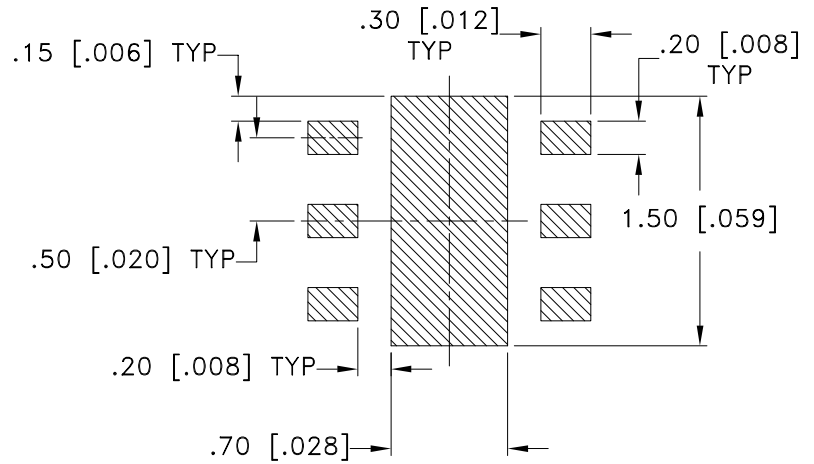

Suggested Layout,  
Tolerance to be within  $\pm 0.050$  mm

### NOTES:

1.  DENOTES METALLIZATION

Weight: .0036 grams

Dimensions are in mm [inches]. Tolerances: 2 Pl.  $\pm 0.05$  mm

### Notes:

1. Case material: Plastic.
2. Termination finish: NiPdAu ( $3\mu\text{m}/0.080\mu\text{m}/0.080\mu\text{m}$ ).



P.O. Box 350166, Brooklyn, New York 11235-0003 (718) 934-4500 Fax (718) 332-4661 For detailed performance specs & shopping online see Mini-Circuits web site



The Design Engineers Search Engine Provides ACTUAL Data Instantly From MINI-CIRCUITS At: [www.minicircuits.com](http://www.minicircuits.com)

RF/IF MICROWAVE COMPONENTS

THIRD ANGLE PROJECTION

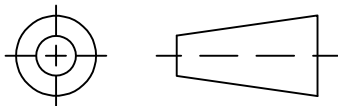

REVISIONS

REV	ECN No.	DESCRIPTION	DATE	DR	AUTH
OR	ECO-023573	NEW RELEASE	11/08/24	ITG	IL

SUGGESTED MOUNTING CONFIGURATION FOR  
KC3009 CASE STYLE

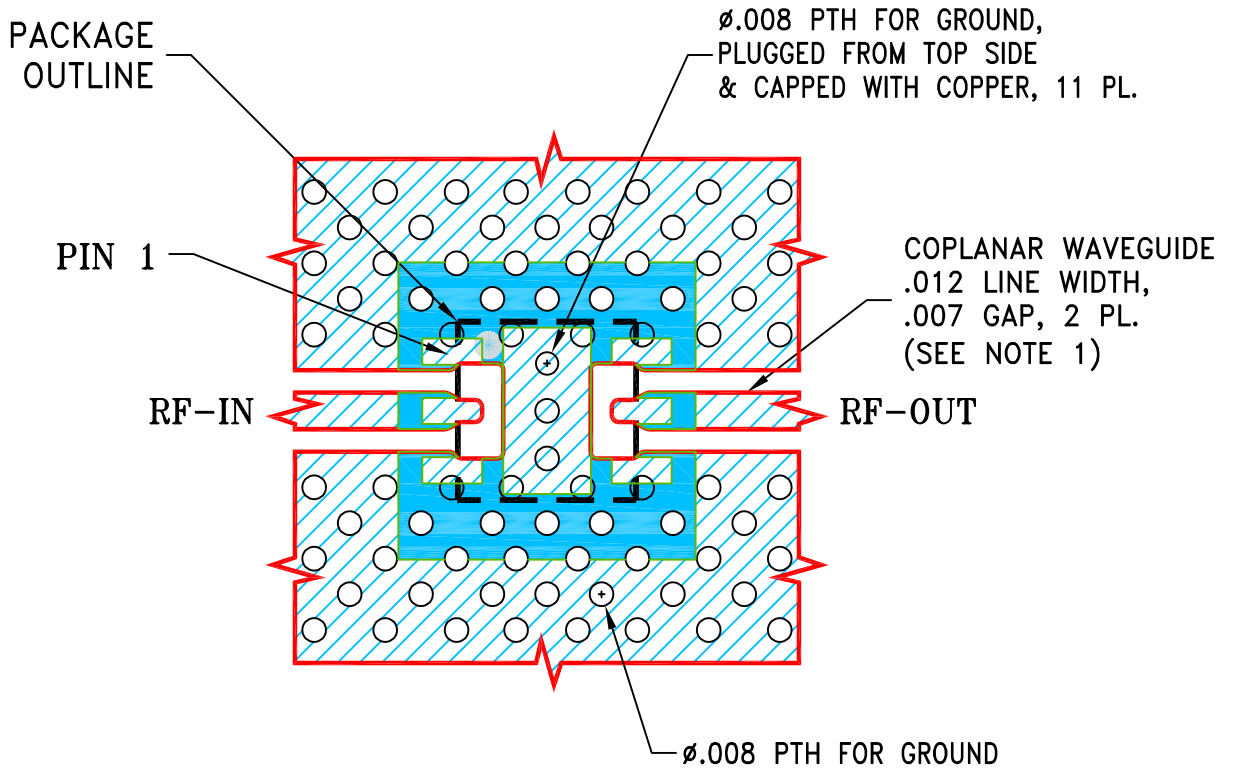

NOTES:

1. LINE WIDTH AND GAP ARE SHOWN FOR ROGERS R04350B WITH DIELECTRIC THICKNESS .0066"; COPPER: 1 OZ. EACH SIDE.  
FOR OTHER MATERIALS LINE WIDTH AND GAP MAY NEED TO BE MODIFIED.
2. BOTTOM SIDE OF THE PCB IS CONTINUOUS GROUND PLANE.

- DENOTES PCB COPPER LAYOUT WITH SMOBC (SOLDER MASK OVER BARE COPPER).
- DENOTES COPPER LAND PATTERN FREE OF SOLDER MASK.

UNLESS OTHERWISE SPECIFIED	INITIALS	DATE
DIMENSIONS ARE IN INCHES	DRAWN ITG	11/08/24
TOLERANCES ON:	CHECKED GF	11/08/24
2 PL DECIMALS ±	APPROVED IL	11/08/24
3 PL DECIMALS ± .005		
ANGLES ±		
FRACTIONS ±		

**Mini-Circuits<sup>®</sup>** 13 Neptune Avenue  
Brooklyn NY 11235

PL,KC3009,TB-BAT-#+/TB-BAT-#C+

SIZE A	CODE IDENT 15542	DRAWING NO: 98-PL-801	REV: OR
FILE: 98PL801	SCALE: 15:1	SHEET: 1 OF 1	

Mini-Circuits<sup>®</sup>  
THIS DOCUMENT AND ITS CONTENTS ARE THE PROPERTY OF MINI-CIRCUITS. EXCEPT FOR USE EXPRESSLY GRANTED, IN WRITING, TO ITS VENDORS, VENDEE AND THE UNITED STATES GOVERNMENT, MINI-CIRCUITS RESERVES ALL PROPRIETARY DESIGN, USE, MANUFACTURING AND REPRODUCTION RIGHTS THERETO. THESE CONTENTS SHALL NOT BE USED, DUPLICATED OR DISCLOSED TO ANY OUTSIDE PARTY, IN WHOLE OR IN PART, WITHOUT WRITTEN PERMISSION OF MINI-CIRCUITS.

# Evaluation Board and Circuit

SEE DETAIL "A"

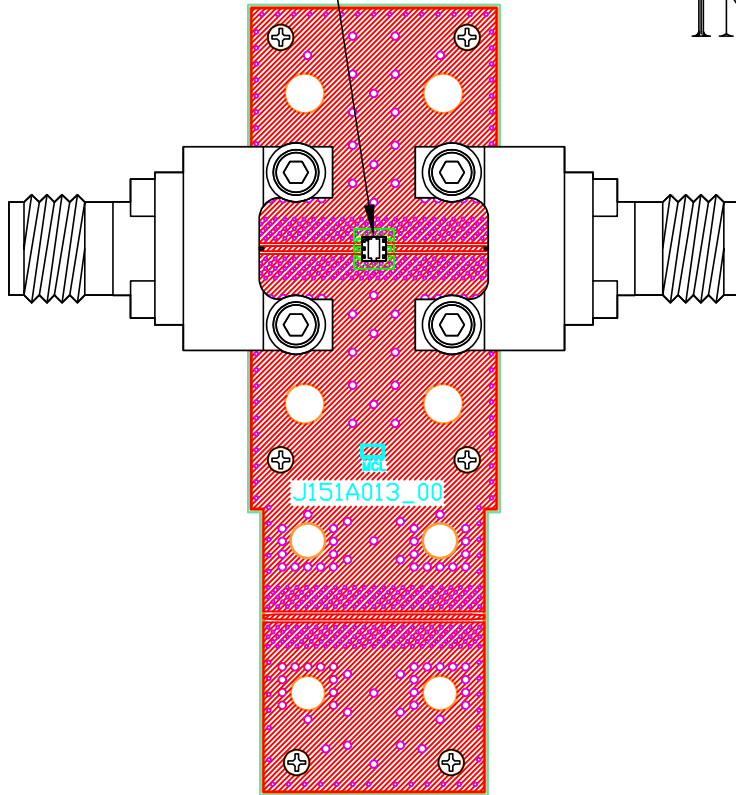

INDEX DUT

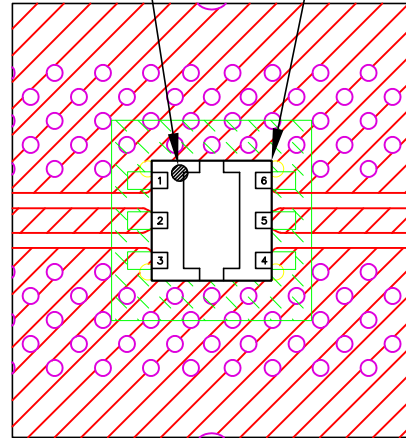

DETAIL "A"  
(SCALE 5:1)

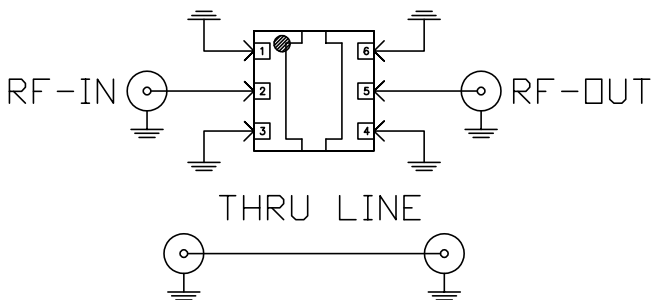

Schematic Diagram  
(Scale 5:1)

Function	Pad
RF-IN	2
RF-OUT	5
GND	1,3,4,6

## NOTES:

- 1.85mm Female Connectors.
- PCB Material: Roger R04350B or equivalent,  
Dielectric constant=3.5, Thickness=0.0066 inch

 **Mini-Circuits®**

All Mini-Circuits products are manufactured under exacting quality assurance and control standards, and are capable of meeting published specifications after being subjected to any or all of the following physical and environmental test.

Specification	Test/Inspection Condition	Reference/Spec
Operating Temperature	-40° to 85° C or -45° to 85° C or -55° to 105° C or -40° to 105° C or -40° to 95° C Ambient Environment	Individual Model Data Sheet
Storage Temperature	-55° to 100° C or -65° to 150° Ambient Environment	Individual Model Data Sheet
HTOL	1000 hours at 125°C	MIL-STD-883, Method 1005, Condition B
Thermal Shock	-55° to 100°C, 100 cycles	MIL-STD-202, Method 107, Condition A-3, except +100°C
Mechanical Shock	1.5Kg, 0.5 ms, 5 shock pulses, Y1 direction only	MIL-STD-883, Method 2002, Condition B, except Y1 direction only
Vibration (Variable Frequency)	50g peak	MIL-STD-883, Method 2007, Condition B
Autoclave	15 psig, 100% RH, 121°C, 96 hours	JESD22-A102, Condition C
HAST	130°C, 85% RH, 96 hours	JESD22-A110
Solderability	10X Magnification	J-STD-002, Para 4.2.5, Test S, 95% Coverage
Solder Reflow Heat	Sn-Pb Eutetic Process: 240°C peak Pb-Free Process: 260°C peak	J-STD-020, Table 4-1, 4-2 and 5-2; Figure 5-1
Moisture Sensitivity: Level 1	Bake at 125°C for 24 hours Soak at 85°C/85% RH for 168 hours, Reflow 3 cycles at 260°C peak	J-STD-020

All Mini-Circuits products are manufactured under exacting quality assurance and control standards, and are capable of meeting published specifications after being subjected to any or all of the following physical and environmental test.

<b>Specification</b>	<b>Test/Inspection Condition</b>	<b>Reference/Spec</b>
Marking Resistance to Solvents	Isopropyl alcohol + mineral spirits at 25°C; terpene defluxer at 25°C; distilled water + proylene glycol monomethyl ether + monoethanolamine at 63°C to 70°C	MIL-STD-202, Method 215