

Wideband, Microwave Monolithic Amplifier Die

AVA-183A-D+

50Ω 5 to 20 GHz

The Big Deal

- Ultra-wideband, 5 to 20 GHz
- Integrated matching, DC blocks, bias circuits
- Unpackaged die form

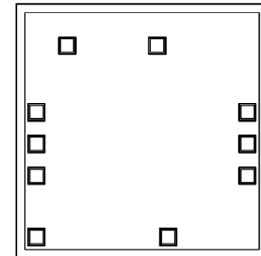

Product Overview

The AVA-183A-D+ is an ultra-wideband microwave amplifier die fabricated using InGaAs PHEMT technology operating over extremely wide frequency range from 5 to 20 GHz. This model integrates the entire matching network with the majority of the bias circuit, reducing the need for complicated external circuits and simplifying board layouts. These advantages make the AVA-183A-D+ extremely user friendly and enable simple, straightforward use.

Key Features

Feature	Advantages
Ultra-wideband, 5 to 20 GHz	Very broad frequency range supports a wide array of applications from microwave radio and radar to military communications and countermeasures, among others.
Excellent gain flatness, ± 1.8 dB	Minimizes the need for external equalizer networks and gain flattening components, making it a great fit for instrumentation and EW applications.
High isolation, 32 to 43 dB	With high reverse isolation (20 – 32 dB directivity), the AVA-123A-D+ is an excellent choice for buffering broadband circuits. It is an ideal LO driver amplifier and provides designers system flexibility and margin when integrating cascaded RF components.
Single +5V supply	<ul style="list-style-type: none">• No hassle associated with amplifiers using dual supply such as power supply sequencing.• Integrated output bias-tee simplifies layout and reduces cost.
Unpackaged die	Enables the user to integrate the amplifier directly into hybrids.



Wideband, Microwave Monolithic Amplifier Die

AVA-183A-D+

Product Features

- Gain, 13.5 dB typ. & Flatness, ± 1.8 dB
- Output Power, up to +19.0 dBm typ.
- Excellent isolation, 39 dB typ. at 12 GHz
- Single Positive Supply Voltage, 5.0V
- Integrated DC blocks, Bias-Tee & Microwave bypass capacitor
- Unconditionally Stable

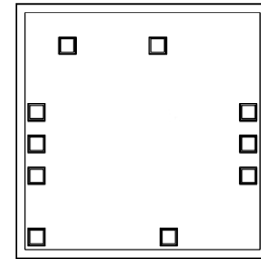

+RoHS Compliant

The +Suffix identifies RoHS Compliance. See our web site for RoHS Compliance methodologies and qualifications

Ordering Information: Refer to Last Page

Typical Applications

- Military EW and Radar
- DBS
- Wideband Isolation amplifier
- Microwave point-to-point radios
- Satellite systems

General Description

The AVA-183A-D+ is a wideband monolithic amplifier die fabricated using InGaAs PHEMT technology with outstanding gain flatness up to 20 GHz. It is manufactured using PHEMT technology and is unconditionally stable. Its outstanding isolation enables it to be used as a wideband isolation amplifier or buffer amplifier in a variety of microwave systems.

Simplified Schematic and Pad description

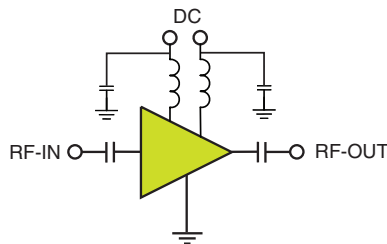

Function	Description
RF-IN	RF input pad
RF-OUT	RF output pad
DC (V_{D1} , V_{D2})	DC power supply
GND	Connected to ground

Note: 1. Bond Pad material - Gold
2. Bottom of Die - Gold plated

Electrical Specifications⁽¹⁾ at 25°C, Zo=50Ω, (refer to characterization circuit, Fig. 1)

Parameter	Condition (GHz)	Min.	Typ.	Max.	Units
Frequency Range		5.0		20.0	GHz
DC Voltage (V _{D1} , V _{D2})			5.0		V
DC Current (I _{D1} +I _{D2})		104	131	166	mA
Gain	5.0		11.4		dB
	8.0		15.1		
	10.0		14.5		
	12.0		13.9		
	14.0		13.6		
	16.0		13.5		
	20.0		12.1		
Input Return Loss	5.0		8.2		dB
	8.0		17.2		
	10.0		12.9		
	12.0		12.0		
	14.0		12.2		
	16.0		12.8		
	20.0		9.3		
Output Return Loss	5.0		6.2		dB
	8.0		15.1		
	10.0		11.8		
	12.0		10.3		
	14.0		9.8		
	16.0		9.8		
	20.0		14.8		
Output IP3 ⁽²⁾	5.0		25.5		dBm
	8.0		28.4		
	10.0		27.0		
	12.0		25.8		
	14.0		34.9		
	16.0		25.2		
	20.0		27.8		
Output Power @ 1 dB compression	5.0		15.2		dBm
	8.0		17.9		
	10.0		18.2		
	12.0		18.3		
	14.0		18.9		
	16.0		19.2		
	20.0		15.8		
Noise Figure	5.0		8.0		dB
	8.0		4.1		
	10.0		4.3		
	12.0		4.8		
	14.0		5.8		
	16.0		6.3		
	20.0		6.2		
Directivity (Isolation-Gain)	12		25.0		dB
DC Current Variation vs. Voltage			0.002		mA/mV
Thermal Resistance			51		°C/W

Absolute Maximum Ratings⁽³⁾

Parameter	Ratings
Operating Temperature	-40°C to 85°C
Channel Temperature	150°C
DC Voltage V _{D1} , V _{D2} Pad ⁽⁴⁾	5.5 V
DC Voltage RF-IN & RF OUT ⁽⁴⁾	10 V
Power Dissipation	980 mW
DC Current V _{D1} & V _{D2}	180 mA
Input Power (CW)	20 dBm

1. Measured on Mini-Circuits Die Characterization test board
See Characterization Test Circuit (Fig. 1)

2. At Pout=8 dBm/tone

3. Permanent damage may occur if any of these limits are exceeded.
These maximum ratings are not intended for continuous normal operation.
Measured in industry standard 3x3 min 8-lead MCLP package

4. For continuous operation do not exceed 5.2V

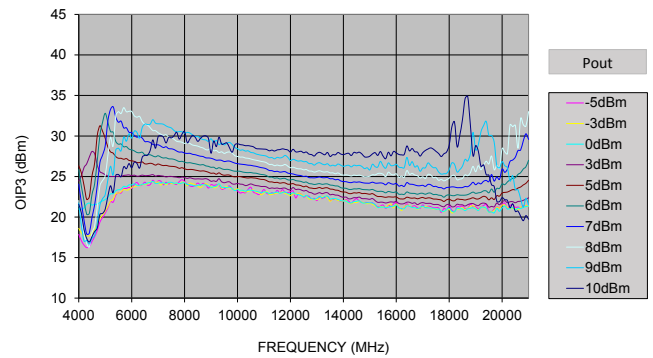
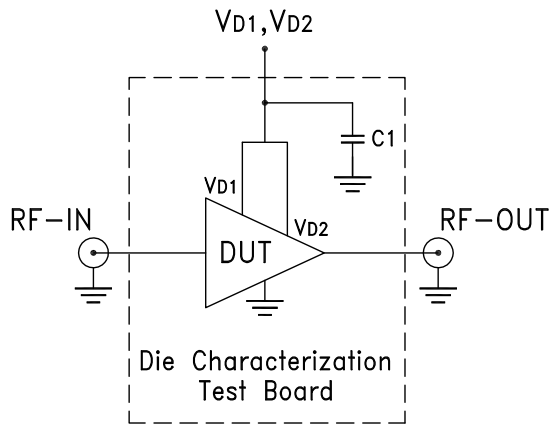

Figure 1: Test Circuit used for characterization. Gain, Return loss, Output power at 1dB compression (P1 dB), output IP3 (OIP3) and noise figure measured using Agilent's N5242A PNA-X microwave network analyzer.

Conditions:

1. Gain and Return loss: Pin= -25dBm
2. Output IP3 (OIP3): Two tones, spaced 1 MHz apart, 8 dBm/tone at output.

Die Layout

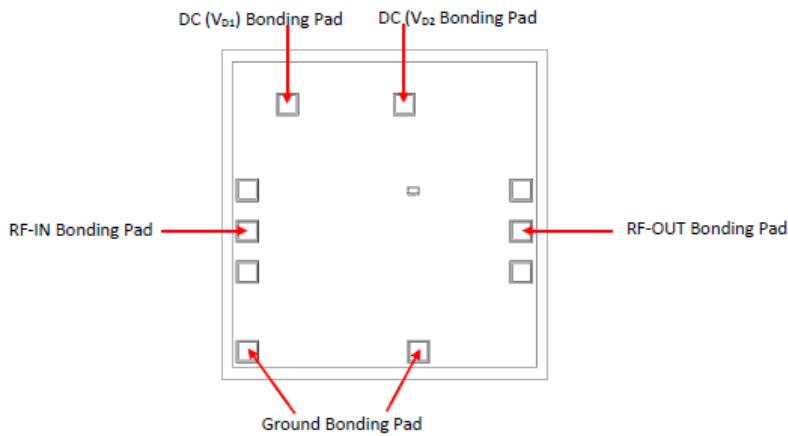

Fig 2. Die Layout

Bonding Pad Position (Dimensions in μm , Typical)

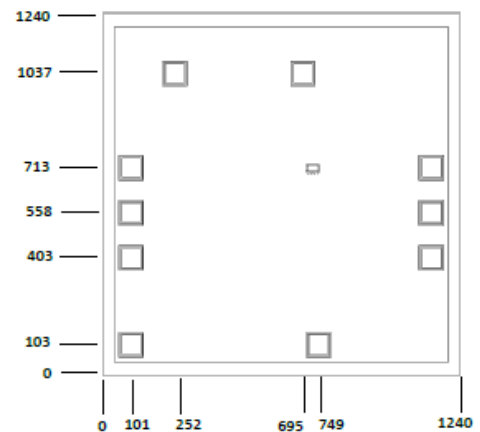

Fig 3. Bonding Pad Positions

Critical Dimensions

Parameter	Values
Die Thickness, μm	100
Die Width, μm	1240
Die Length, μm	1240
Bond Pad Size, μm	80 x 80

Assembly and Handling Procedure

1. Storage
Dice should be stored in a dry nitrogen purged desiccators or equivalent.
2. ESD
MMIC PHEMT amplifier dice are susceptible to electrostatic and mechanical damage. Die are supplied in antistatic protected material, which should be opened in clean room conditions at an appropriately grounded anti-static workstation. Devices need careful handling using correctly designed collets, vacuum pickup tips or sharp antistatic tweezers to deter ESD damage to dice.
3. Die Attach
The die mounting surface must be clean and flat. Using conductive silver filled epoxy, recommended epoxies are DieMat DM6030HK-PT/H579 or Ablestik 84-1LMISR4. Apply sufficient epoxy to meet required epoxy bond line thickness, epoxy fillet height and epoxy coverage around total die periphery. Parts shall be cured in a nitrogen filled atmosphere per manufacturer's cure condition. It is recommended to use antistatic die pick up tools only.
4. Wire Bonding
Bond pad openings in the surface passivation above the bond pads are provided to allow wire bonding to the dice gold bond pads. Thermosonic bonding is used with minimized ultrasonic content. Bond force, time, ultrasonic power and temperature are all critical parameters. Suggested wire is pure gold, 1 mil diameter. Bonds must be made from the bond pads on the die to the package or substrate. All bond wires should be kept as short as low as reasonable to minimize performance degradation due to undesirable series inductance.

Assembly Diagram

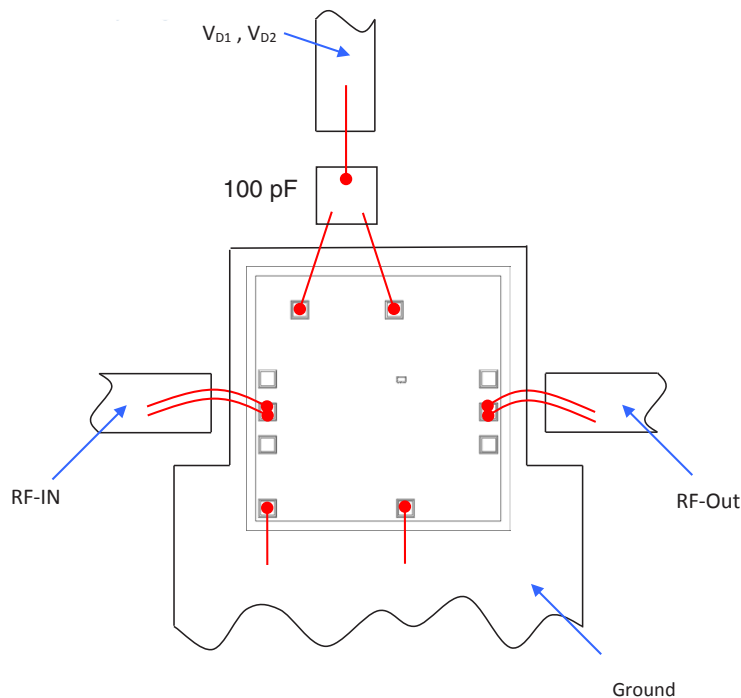

Recommended Wire Length, Typical

Wire	Wire Length (mm)	Wire Loop Height (mm)
RF-In, RF-Out	0.25	0.15
VD1, VD2	0.50	0.15
Ground	0.25	0.15

Typical Performance Data

Definitions:

Input Return Loss = -S11 (dB)

Gain(Power Gain) = S21 (dB)

Reverse Isolation = -S12 (dB)

Output Return Loss = -S22 (dB)

TEST CONDITIONS: Vd = 5V, Id = 135mA @Temperature = +25°C

FREQ.	Gain	Isolation	Input Return Loss	Output Return Loss	Stability		IP-3 Output	1dB Comp. Output	Noise Figure
					K	Measure			
(GHz)	(dB)	(dB)	(dB)	(dB)	K	Measure	(dBm)	(dBm)	(dB)
5.0	11.55	43.98	8.43	6.30	13.89	0.87	25.63	15.33	7.90
5.2	12.49	43.06	9.30	7.46	12.37	0.91	32.28	16.23	7.02
5.4	13.20	42.57	10.35	8.73	11.68	0.94	35.45	16.33	6.47
5.6	13.74	41.70	11.56	10.09	10.58	0.96	35.11	16.53	5.76
5.8	14.18	41.16	12.94	11.50	9.93	0.97	33.02	16.68	5.39
6.0	14.51	40.78	14.51	12.92	9.48	0.98	32.42	17.12	5.07
6.2	14.73	40.44	16.21	14.30	9.12	0.98	31.31	17.30	4.60
6.4	14.90	39.94	17.98	15.53	8.59	0.98	30.51	17.33	4.61
6.6	15.03	39.85	19.74	16.48	8.47	0.98	30.55	17.61	4.26
6.8	15.12	39.68	21.10	17.04	8.26	0.98	29.78	17.59	4.24
7.0	15.14	39.47	21.67	17.19	8.05	0.98	29.26	17.70	4.21
7.2	15.19	39.41	21.33	17.00	7.95	0.98	29.13	17.92	3.92
7.4	15.16	39.44	20.47	16.58	7.97	0.98	28.95	17.69	4.10
7.6	15.15	39.40	19.45	16.09	7.90	0.98	28.68	17.99	3.92
7.8	15.09	39.57	18.41	15.56	8.06	0.98	28.56	17.80	4.02
8.0	15.08	39.44	17.49	15.06	7.89	0.98	28.39	18.06	4.01
8.2	15.01	39.53	16.68	14.57	7.98	0.98	28.34	17.81	3.98
8.4	14.98	39.54	16.01	14.12	7.96	0.98	28.10	17.52	4.09
8.6	14.92	39.38	15.44	13.72	7.82	0.98	27.89	17.98	3.99
8.8	14.86	39.47	14.93	13.35	7.89	0.98	27.74	17.97	4.08
9.0	14.81	39.64	14.51	13.04	8.04	0.98	28.02	18.92	4.14
9.2	14.73	39.54	14.15	12.75	7.96	0.98	27.76	18.24	4.03
9.4	14.67	39.49	13.82	12.46	7.91	0.98	27.56	18.50	4.28
9.6	14.60	39.63	13.55	12.23	8.06	0.98	27.44	17.98	4.16
9.8	14.52	39.75	13.31	12.01	8.20	0.98	27.43	17.24	4.37
10.0	14.49	39.70	13.12	11.82	8.14	0.97	26.99	18.25	4.27
10.5	14.31	39.55	12.74	11.35	8.07	0.97	26.73	18.35	4.44
11.0	14.19	39.55	12.47	10.98	8.09	0.97	26.45	18.74	4.58
11.5	14.08	39.71	12.28	10.68	8.28	0.96	26.17	18.89	4.65
12.0	13.93	39.62	12.21	10.43	8.28	0.96	25.79	18.38	4.73
12.5	13.84	39.49	12.14	10.23	8.20	0.95	25.64	18.69	4.72
13.0	13.73	39.47	12.13	10.10	8.25	0.95	25.37	17.46	4.86
13.5	13.68	39.21	12.24	10.02	8.06	0.95	25.12	18.25	4.82
14.0	13.61	38.77	12.36	9.95	7.73	0.94	24.94	18.99	4.96
14.5	13.58	38.27	12.51	9.91	7.33	0.94	25.06	18.86	5.04
15.0	13.56	37.65	12.71	9.91	6.87	0.94	24.83	18.97	5.28
15.5	13.56	36.76	12.83	9.87	6.21	0.94	25.24	17.59	5.10
16.0	13.55	36.23	12.95	9.95	5.87	0.94	25.30	19.25	5.31
16.5	13.54	35.78	13.06	10.12	5.61	0.94	25.10	18.32	5.22
17.0	13.51	35.09	13.09	10.41	5.23	0.95	24.89	19.08	5.29
17.5	13.48	34.32	12.97	10.79	4.83	0.96	24.75	18.77	5.22
18.0	13.41	33.86	12.56	11.32	4.64	0.97	24.58	18.47	5.41
18.5	13.26	33.13	11.91	12.00	4.34	0.99	24.54	17.85	5.42
19.0	13.03	32.79	11.11	12.97	4.27	1.02	25.05	16.85	5.71
19.5	12.64	32.46	10.25	13.99	4.25	1.05	25.40	16.63	5.98
20.0	12.12	32.13	9.34	14.80	4.27	1.08	28.10	15.88	6.19



Typical Performance Data

Definitions:

Input Return Loss = -S11 (dB)

Gain(Power Gain) = S21 (dB)

Reverse Isolation = -S12 (dB)

Output Return Loss = -S22 (dB)

TEST CONDITIONS: Vd = 4.75V, Id = 135mA @Temperature = +25°C

FREQ.	Gain	Isolation	Input Return Loss	Output Return Loss	Stability		IP-3 Output	1dB Comp. Output	Noise Figure
					K	Measure			
(GHz)	(dB)	(dB)	(dB)	(dB)	K	Measure	(dBm)	(dBm)	(dB)
5.0	11.70	43.78	8.43	6.29	13.33	0.87	23.19	14.85	7.87
5.2	12.63	43.22	9.28	7.45	12.38	0.91	27.38	15.73	6.98
5.4	13.33	42.13	10.32	8.73	10.93	0.94	29.79	15.77	6.42
5.6	13.87	41.62	11.51	10.09	10.33	0.96	30.05	15.96	5.78
5.8	14.30	41.19	12.85	11.51	9.82	0.97	31.84	16.11	5.37
6.0	14.62	40.72	14.38	12.95	9.29	0.98	31.94	16.55	5.00
6.2	14.85	40.43	16.04	14.36	8.98	0.98	33.00	16.74	4.66
6.4	15.02	39.97	17.75	15.63	8.50	0.98	32.74	16.60	4.64
6.6	15.14	39.81	19.45	16.64	8.33	0.98	32.27	17.04	4.21
6.8	15.23	39.66	20.80	17.24	8.14	0.98	31.61	17.03	4.19
7.0	15.26	39.43	21.46	17.44	7.92	0.98	30.73	17.13	4.21
7.2	15.30	39.48	21.26	17.25	7.92	0.98	30.66	17.20	3.92
7.4	15.28	39.35	20.50	16.84	7.79	0.98	30.38	17.12	4.08
7.6	15.27	39.36	19.52	16.33	7.77	0.98	29.76	17.43	3.87
7.8	15.22	39.44	18.55	15.78	7.84	0.98	29.79	17.09	3.99
8.0	15.21	39.54	17.67	15.26	7.89	0.98	29.60	17.36	3.98
8.2	15.14	39.42	16.85	14.75	7.79	0.98	29.58	17.09	3.95
8.4	15.12	39.51	16.18	14.30	7.84	0.98	29.08	16.95	4.10
8.6	15.05	39.40	15.61	13.88	7.74	0.98	28.81	17.42	3.96
8.8	15.00	39.52	15.11	13.50	7.84	0.98	28.72	17.26	4.03
9.0	14.96	39.48	14.70	13.18	7.79	0.98	29.26	18.39	4.09
9.2	14.88	39.43	14.32	12.89	7.76	0.98	28.98	17.68	3.99
9.4	14.82	39.56	13.99	12.60	7.87	0.98	28.60	17.95	4.21
9.6	14.76	39.79	13.73	12.36	8.10	0.98	28.44	17.42	4.13
9.8	14.68	39.69	13.49	12.13	8.03	0.98	28.51	16.52	4.30
10.0	14.66	39.74	13.31	11.94	8.06	0.97	27.77	17.72	4.23
10.5	14.49	39.64	12.92	11.47	8.02	0.97	27.27	17.79	4.40
11.0	14.38	39.48	12.66	11.08	7.90	0.97	26.94	18.10	4.56
11.5	14.28	39.58	12.46	10.76	8.01	0.96	26.87	18.42	4.61
12.0	14.14	39.51	12.39	10.53	8.02	0.96	26.42	17.71	4.65
12.5	14.06	39.50	12.32	10.31	8.04	0.95	26.31	18.02	4.77
13.0	13.96	39.24	12.30	10.17	7.87	0.95	25.95	16.91	4.82
13.5	13.92	39.01	12.43	10.09	7.71	0.95	25.66	17.73	4.79
14.0	13.87	38.38	12.56	10.01	7.22	0.94	25.72	18.33	4.93
14.5	13.84	38.18	12.71	9.98	7.08	0.94	25.97	18.36	5.06
15.0	13.83	37.37	12.94	9.97	6.48	0.94	25.68	18.53	5.11
15.5	13.84	36.69	13.06	9.94	6.00	0.93	26.36	16.93	5.05
16.0	13.83	35.96	13.19	10.02	5.54	0.93	26.66	18.78	5.23
16.5	13.83	35.64	13.31	10.20	5.36	0.94	26.51	17.68	5.18
17.0	13.81	34.95	13.32	10.51	5.00	0.95	26.27	18.51	5.30
17.5	13.78	34.29	13.19	10.92	4.68	0.96	26.15	18.26	5.24
18.0	13.70	33.57	12.71	11.49	4.36	0.97	25.83	17.83	5.34
18.5	13.55	33.10	12.01	12.23	4.21	1.00	26.18	17.20	5.36
19.0	13.31	32.75	11.16	13.29	4.14	1.02	28.05	16.28	5.67
19.5	12.90	32.32	10.25	14.42	4.08	1.05	29.04	15.94	5.88
20.0	12.36	32.10	9.32	15.30	4.16	1.09	29.08	15.18	6.10



Typical Performance Data

Definitions:

Input Return Loss = -S11 (dB)

Gain(Power Gain) = S21 (dB)

Reverse Isolation = -S12 (dB)

Output Return Loss = -S22 (dB)

TEST CONDITIONS: Vd = 5.25V, Id = 136mA @Temperature = +25°C

FREQ.	Gain	Isolation	Input Return Loss	Output Return Loss	Stability		IP-3 Output	1dB Comp. Output	Noise Figure
					K	Measure			
(GHz)	(dB)	(dB)	(dB)	(dB)	K	Measure	(dBm)	(dBm)	(dB)
5.0	11.42	43.87	8.43	6.30	13.90	0.87	28.49	15.79	7.93
5.2	12.38	43.26	9.31	7.45	12.82	0.91	34.45	16.59	7.04
5.4	13.09	42.51	10.37	8.72	11.74	0.94	32.18	16.86	6.49
5.6	13.64	41.79	11.59	10.07	10.82	0.96	31.49	17.08	5.81
5.8	14.08	40.98	13.00	11.45	9.84	0.97	30.73	17.24	5.38
6.0	14.41	40.62	14.58	12.87	9.42	0.98	30.20	17.67	5.09
6.2	14.63	40.30	16.33	14.22	9.07	0.98	29.68	17.86	4.65
6.4	14.81	39.90	18.17	15.40	8.64	0.98	29.40	17.90	4.67
6.6	14.93	39.62	20.01	16.33	8.34	0.98	29.27	18.18	4.35
6.8	15.02	39.57	21.35	16.85	8.24	0.98	28.96	18.16	4.23
7.0	15.05	39.53	21.84	16.97	8.19	0.98	28.74	18.40	4.25
7.2	15.09	39.47	21.38	16.76	8.09	0.98	28.59	18.48	3.97
7.4	15.06	39.26	20.43	16.35	7.89	0.98	28.46	18.39	4.12
7.6	15.05	39.40	19.33	15.87	7.98	0.98	28.34	18.55	3.93
7.8	14.99	39.37	18.25	15.37	7.96	0.98	28.12	18.36	4.05
8.0	14.98	39.41	17.33	14.87	7.95	0.98	27.98	18.62	4.06
8.2	14.90	39.36	16.51	14.40	7.91	0.98	27.92	18.37	3.99
8.4	14.87	39.48	15.84	13.97	7.99	0.98	27.79	18.23	4.08
8.6	14.80	39.59	15.25	13.57	8.10	0.98	27.62	18.54	3.99
8.8	14.74	39.45	14.76	13.21	7.96	0.98	27.46	18.52	4.17
9.0	14.69	39.45	14.33	12.90	7.95	0.98	27.44	19.43	4.19
9.2	14.60	39.80	13.96	12.61	8.29	0.98	27.29	18.78	4.06
9.4	14.54	39.37	13.65	12.35	7.90	0.98	27.19	19.04	4.31
9.6	14.47	39.67	13.38	12.12	8.20	0.98	27.06	18.53	4.19
9.8	14.38	39.83	13.14	11.89	8.37	0.98	27.01	17.79	4.41
10.0	14.34	39.76	12.96	11.70	8.30	0.97	26.83	18.75	4.30
10.5	14.16	39.77	12.58	11.25	8.39	0.97	26.66	19.02	4.48
11.0	14.03	39.59	12.32	10.89	8.26	0.97	26.40	19.20	4.64
11.5	13.90	39.85	12.12	10.58	8.54	0.96	26.03	19.31	4.68
12.0	13.75	39.61	12.04	10.35	8.41	0.96	25.74	18.88	4.75
12.5	13.65	39.57	11.98	10.16	8.42	0.96	25.60	19.19	4.85
13.0	13.53	39.42	11.96	10.01	8.36	0.95	25.34	18.12	4.92
13.5	13.47	39.47	12.07	9.95	8.48	0.95	25.12	18.89	4.91
14.0	13.39	38.71	12.20	9.87	7.84	0.94	24.82	19.47	5.05
14.5	13.35	38.38	12.34	9.84	7.59	0.94	24.86	19.34	5.07
15.0	13.32	37.74	12.52	9.82	7.10	0.94	24.66	19.38	5.31
15.5	13.32	36.84	12.63	9.79	6.41	0.94	24.75	18.22	5.22
16.0	13.30	36.33	12.76	9.88	6.08	0.94	24.72	19.81	5.36
16.5	13.28	35.71	12.86	10.03	5.70	0.94	24.58	18.94	5.28
17.0	13.26	35.17	12.90	10.30	5.40	0.95	24.48	19.53	5.39
17.5	13.23	34.49	12.82	10.65	5.05	0.96	24.33	19.35	5.32
18.0	13.15	33.85	12.44	11.15	4.74	0.97	24.23	18.98	5.51
18.5	13.01	33.23	11.83	11.78	4.49	0.99	24.00	18.38	5.49
19.0	12.80	32.92	11.07	12.68	4.43	1.02	24.09	17.48	5.82
19.5	12.43	32.52	10.24	13.63	4.37	1.05	24.33	17.28	6.02
20.0	11.92	32.19	9.37	14.37	4.38	1.08	25.13	16.45	6.27



Typical Performance Curves

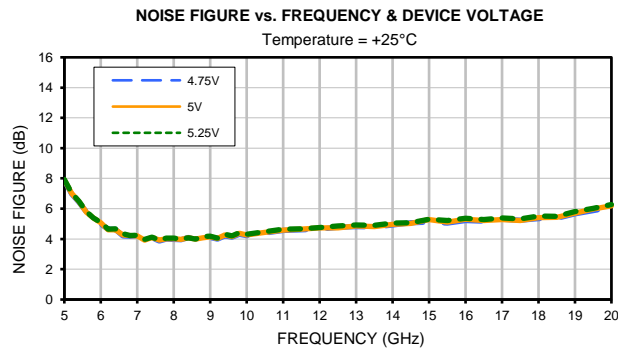
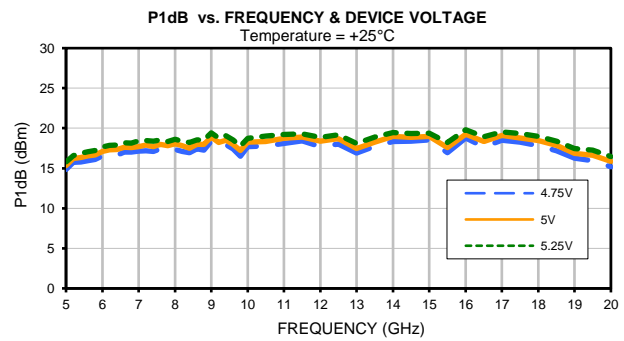
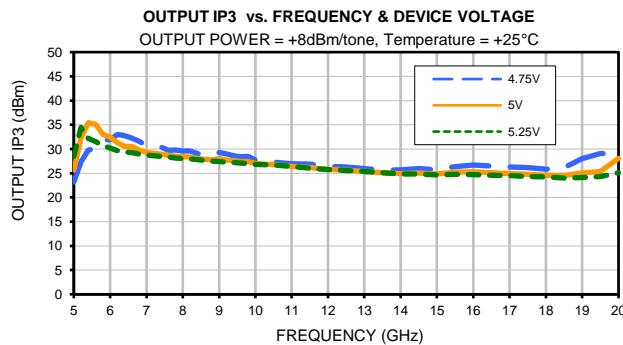
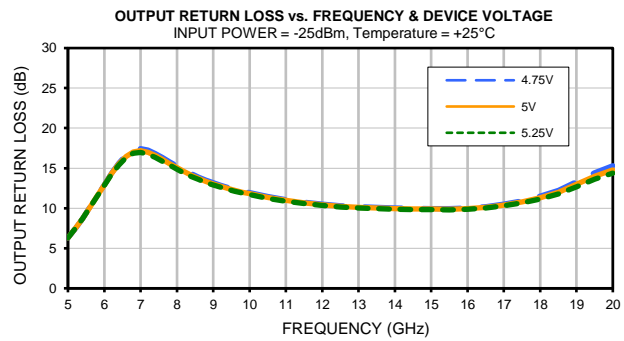
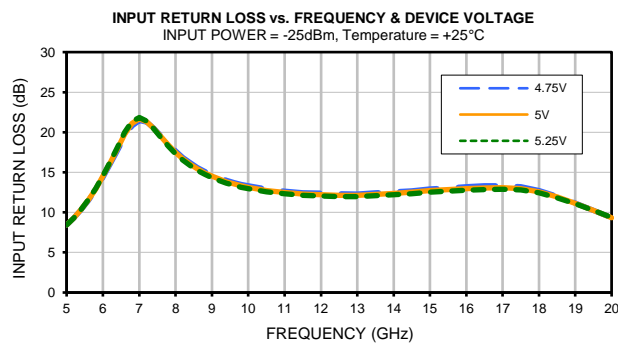
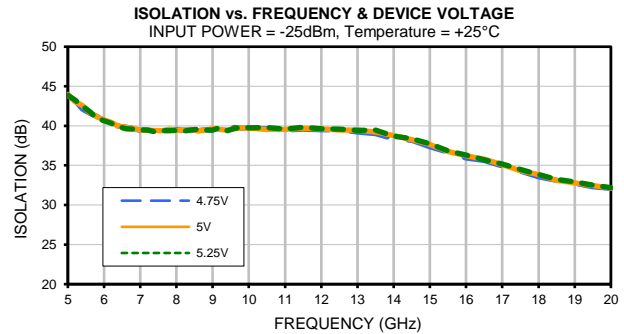
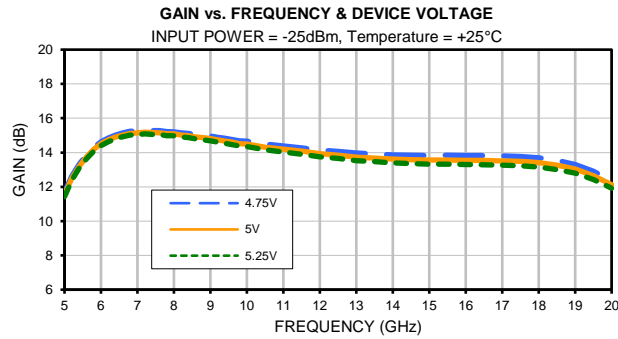

All Mini-Circuits products are manufactured under exacting quality assurance and control standards, and are capable of meeting published specifications after being subjected to any or all of the following physical and environmental test.

Specification	Test/Inspection Condition	Reference/Spec
Operating Temperature	-40° to 85° C or -40° to 105° C or -55° to 105° C or -45° to 105° C Ambient Environment	Refer to Individual Model Data Sheet
Storage Environment (Die)	-65° to 150°C	Individual Model Data Sheet
Storage Environment(Packaging)	-40° to 70°C and 40 to 60% humidity (In Factory Shipped Package)	