



WIDEBAND, MICROWAVE

Monolithic Amplifier

AVA-183A+

50Ω 5 to 18 GHz

THE BIG DEAL

- Surface Mount Amplifier Up to 18 GHz
- Integrated DC blocks, Bias-Tee & Microwave Bypass Capacitor
- Suitable for Low Phase Noise Applications
- Gain, 13.4 dB Typ. & Flatness, ±1.2 dB
- P1dB, Typ. +19.0 dBm
- Output Power, Up to +19.0 dBm Typ.
- Excellent Isolation, 36 dB Typ. at 12 GHz
- Single Positive Supply Voltage, +5 V
- Unconditionally Stable
- Aqueous Washable; 3 mm x 3 mm SMT Package

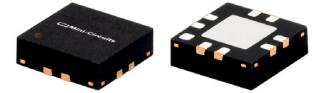

Generic photo used for illustration purposes only

CASE STYLE: DQ849

+RoHS Compliant

The +Suffix identifies RoHS Compliance. See our website for methodologies and qualifications

APPLICATIONS

- Military EW and Radar
- DBS
- Microwave Point-to-Point Radios
- Satellite Systems

PRODUCT OVERVIEW

The AVA-183A+ is a surface-mount microwave amplifier fabricated using InGaAs pHEMT technology and is a fully integrated gain block up to 18 GHz. It is packaged in Mini-Circuits industry standard 3x3 mm MCLP package, which provides excellent RF and thermal performance. The AVA-183A+ integrates the entire matching network with the majority of the bias circuit inside the package, reducing the need for complicated external circuits. This approach makes the AVA-183A+ extremely flexible and enables simple, straightforward use.

KEY FEATURES

Feature	Advantages
Wideband, 5 to 18 GHz	Broad frequency range supports a wide array of applications from microwave radio and radar , to military communications and countermeasures.
Excellent Gain Flatness	Typical ±1.2 dB gain flatness across the entire frequency range minimizes the need for external equalizer networks making it a great fit for instrumentation and EW applications.
High Isolation	With reverse isolation of 31-42 dB (17-23 dB directivity), the AVA-183A+ is an excellent choice for buffering broadband circuits. It is an ideal LO driver amplifier and provides designers system flexibility and margin when integrating cascaded RF components.
Single +5 V Supply	This single-supply implementation is much simpler to use than competing amplifiers with dual supply voltages. No power supply sequencing or complicated bias tee circuits are required, reducing board space and cost.
Manufacturability	MSL1 and ESD Class 1A (HBM) ratings minimize special handling on production lines.
Low Additive Phase Noise, Typically -151 dBc/Hz @10 KHz Offset	Ideal for low phase noise synthesizer applications





WIDEBAND, MICROWAVE

Monolithic Amplifier

AVA-183A+

50Ω 5 to 18 GHz

ELECTRICAL SPECIFICATIONS¹ AT 25°C, Z₀=50Ω, (REFER TO CHARACTERIZATION CIRCUIT, FIG. 1)

Parameter	Condition (GHz)	Min.	Typ.	Max.	Units
Frequency Range		5.0		18.0	GHz
DC Voltage (V _{D1} , V _{D2})			+5.0		V
DC Current (I _{D1} +I _{D2})		104	131	166	mA
Gain	5.0		12.9		dB
	8.0	12.0	14.7		
	10.0	12.0	14.0		
	12.0		13.4		
	14.0		13.1		
	16.0		13.6		
	18.0	10.8	12.4		
Input Return Loss	5.0		10.4		dB
	8.0		17.0		
	10.0		11.0		
	12.0		11.0		
	14.0		11.0		
	16.0		11.0		
	18.0		7.5		
Output Return Loss	5.0		8.0		dB
	8.0		18.0		
	10.0		14.0		
	12.0		11.0		
	14.0		10.6		
	16.0		11.2		
	18.0		11.8		
Output IP3 ²	5.0		+32.2		dBm
	8.0		+29.0		
	10.0		+27.7		
	12.0		+26.3		
	14.0		+25.1		
	16.0		+24.3		
	18.0		+24.4		
Output Power @ 1 dB Compression	5.0		+17.6		dBm
	8.0		+18.0		
	10.0	+16.0	+19.0		
	12.0		+19.0		
	14.0		+19.9		
	16.0		+19.6		
	18.0		+18.7		
Noise Figure	5.0		7.4		dB
	8.0		4.3		
	10.0		4.5		
	12.0		4.8		
	14.0		5.1		
	16.0		5.1		
	18.0		6.0		
Additive Phase Noise	5.0 GHz, 10 KHz offset		-151		dBc/Hz
Directivity (Isolation-Gain)	12		23.1		dB
DC Current Variation vs. Temperature ³			0.046		mA/°C
Thermal Resistance			61		°C/W

1. Measured on Mini-Circuits Characterization test fixture TB-547-2+. See Characterization Test Circuit (Fig. 1).

2. At P_{OUT}=+9 dBm/tone.

3. (Current at +85°C - Current at -45°C) / 130.

ABSOLUTE MAXIMUM RATINGS⁴

Parameter	Ratings
Operating Temperature ⁵	-40°C to +85°C
Storage Temperature	-65°C to +150°C
Channel Temperature	+150°C
DC Voltage (Pad 7,8)	+5.5 V
DC Voltage (Pads 2, 5)	+10 V
Power Dissipation	980 mW
DC Current (Pad 7+8)	180 mA
Input Power (CW)	+20 dBm

4. Permanent damage may occur if any of these limits are exceeded. These maximum ratings are not intended for continuous normal operation.

5. Defined with reference to ground pad temperature.





WIDEBAND, MICROWAVE

Monolithic Amplifier

AVA-183A+

50Ω 5 to 18 GHz

INTERMODULATION AND IP3 VS. FREQUENCY AND OUTPUT POWER

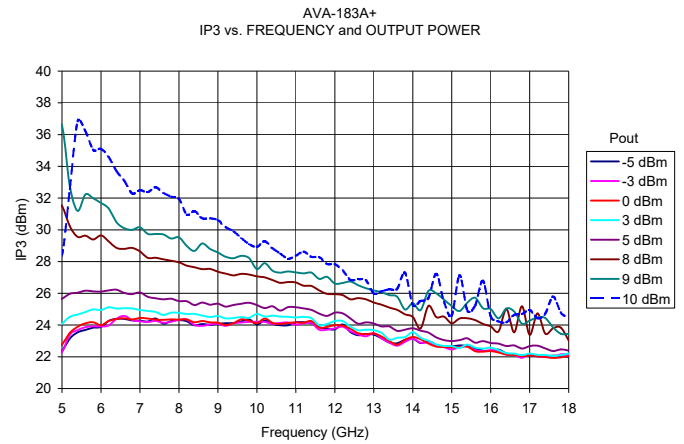
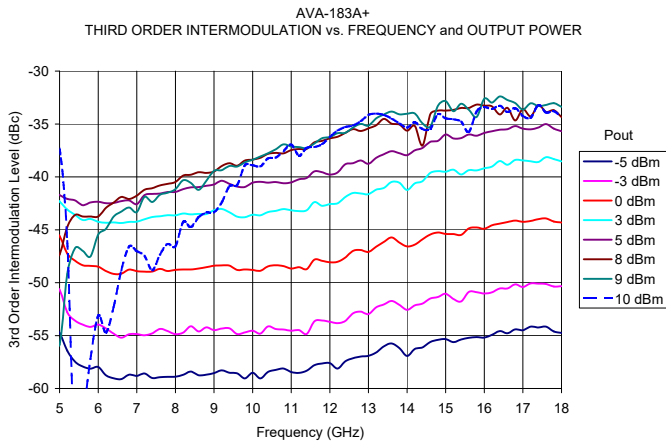

SIMPLIFIED SCHEMATIC AND PAD DESCRIPTION

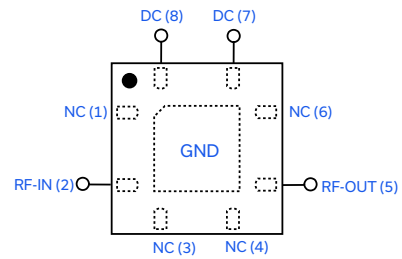
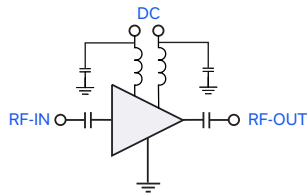

Function	Pad Number	Description (See Application Circuit, Fig. 2)
RF-IN	2	RF input pad
RF-OUT	5	RF output pad
DC	8(V_{D1}), 7(V_{D2})	DC power supply
GND	Paddle in Center of Bottom	Connected to ground
NOT USED	1,3,4,6	No internal connection; recommended use: per PCB Layout PL-328





WIDEBAND, MICROWAVE

Monolithic Amplifier

AVA-183A+

50Ω 5 to 18 GHz

CHARACTERIZATION TEST CIRCUIT

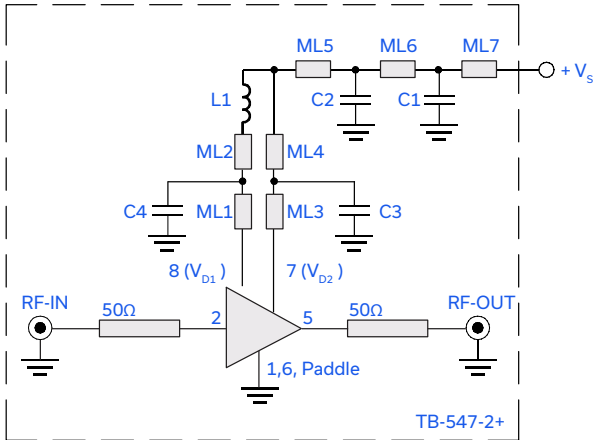

Fig 1. Block Diagram of Test Circuit used for characterization. (DUT soldered on Mini-Circuits Characterization Test Board TB-547-2+) Gain, Output Power at 1 dB Compression (P1dB), Noise Figure, Output IP3 (OIP3) are measured using Agilent's N5242A PNA-X microwave network analyzer.

Conditions:

1. Gain: $P_{in} = -25$ dBm
2. Output IP3 (OIP3): Two tones, spaced 1 MHz apart, +9 dBm/tone at output.
3. V_s adjusted for +5.0 V at device (V_{D1} and V_{D2}), compensating loss of bias lines.

C1=5.6 pF, 0402 (NPO)
 C2=18 pF, 0402 (NPO)
 C3=0.001 μF, 0402 (NPO)
 C4=0.1 μF, 0402 (X7R)
 L1=3.3 nH, 0805 (wire wound)

ML1-ML7 are short microstrip lines. Refer to 98-PL-328.

RECOMMENDED APPLICATION CIRCUIT

(Refer to Evaluation Board for PCB Layout and Component Values)

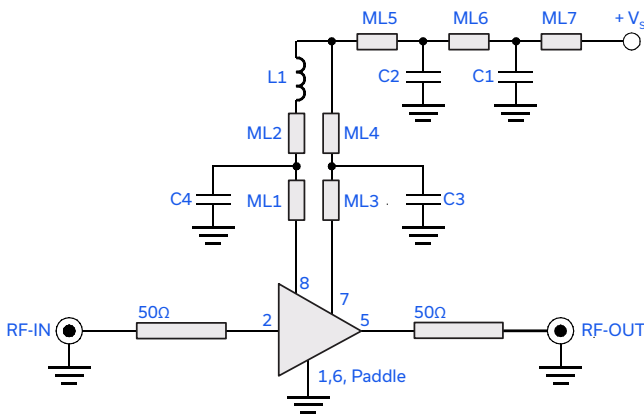
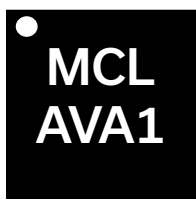

Fig 2. Recommended Application Circuit

C1=5.6 pF, 0402 (NPO)
 C2=18 pF, 0402 (NPO)
 C3=0.001 μF, 0402 (NPO)
 C4=0.1 μF, 0402 (X7R)
 L1=3.3 nH, 0805 (wire wound)

ML1-ML7 are short microstrip lines. Refer to 98-PL-328.

PRODUCT MARKING



- ← Black Body
- ← Model Family Designation

Marking may contain other features or characters for internal lot control.





WIDEBAND, MICROWAVE

Monolithic Amplifier

AVA-183A+

50Ω 5 to 18 GHz

ADDITIONAL DETAILED TECHNICAL INFORMATION IS AVAILABLE ON OUR DASHBOARD. TO ACCESS [CLICK HERE](#)

Performance Data	Data Table Swept Graphs S-Parameter (S2P Files) Data Set (.zip file)
Case Style	DQ849 Plastic package, exposed paddle, lead finish: Matte-tin
Tape & Reel Standard Quantities Available on Reel	F104 7" reels with 20, 50, 100, 200, 500, 1000 or 2000 devices
Suggested Layout for PCB Design	PL-328
Evaluation Board	TB-547-2+
Environmental Ratings	ENV08T1

ESD RATING

Human Body Model (HBM): 1A (250 to <500 V) in accordance with ANSI/ESD STM 5.1 - 2001

Machine Model (MM): M1 (25 V) in accordance with ANSI/ESD STM5.2-1999

MSL RATING

Moisture Sensitivity: MSL1 in accordance with IPC/JEDEC J-STD-020D

MSL TEST FLOW CHART

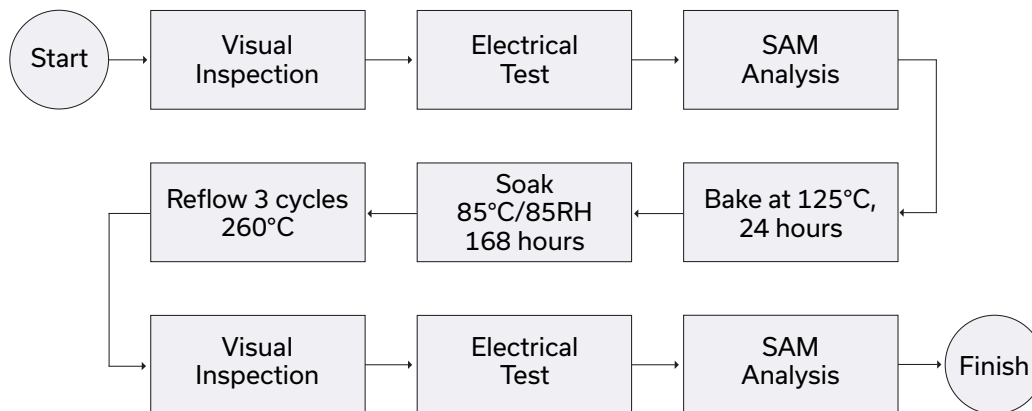

NOTES

- A. Performance and quality attributes and conditions not expressly stated in this specification document are intended to be excluded and do not form a part of this specification document.
- B. Electrical specifications and performance data contained in this specification document are based on Mini-Circuits' applicable established test performance criteria and measurement instructions.
- C. The parts covered by this specification document are subject to Mini-Circuits' standard limited warranty and terms and conditions (collectively, "Standard Terms"); Purchasers of this part are entitled to the rights and benefits contained therein. For a full statement of the standard terms and the exclusive rights and remedies thereunder, please visit Mini-Circuits' website at www.minicircuits.com/terms/viewterm.html



Typical Performance Data

NOTE: Use PDF Bookmarks to view DATA at required conditions

Definitions:

Input Return Loss = -S11 (dB)

Gain(Power Gain) = S21 (dB)

Reverse Isolation = -S12 (dB)

Output Return Loss = -S22 (dB)

TEST CONDITIONS: Vd = 5.00V, Id = 132.12mA @ Temperature = 25degC

FREQ (GHz)	Gain (dB)	Isolation (dB)	Input Return Loss (dB)	Output Return Loss (dB)	Stability		IP-3 Output (dBm)	1dB Comp. Output (dBm)	Noise Figure (dB)
					K	Measure			
5.0	12.93	41.14	11.79	7.77	10.13	0.88	32.66	17.23	7.19
5.2	13.37	40.17	13.87	8.47	9.09	0.88	29.59	17.82	6.52
5.4	13.72	39.50	16.20	9.25	8.44	0.89	30.15	17.86	5.98
5.6	13.96	38.93	18.66	9.76	7.88	0.90	30.59	18.15	5.60
5.8	14.15	38.57	20.99	10.38	7.55	0.91	31.46	17.78	5.28
6.0	14.29	38.04	22.30	10.85	7.08	0.92	34.16	17.96	5.06
6.2	14.40	37.74	22.08	11.54	6.84	0.93	30.07	17.91	4.84
6.4	14.50	37.46	21.65	11.97	6.58	0.94	28.87	18.07	4.69
6.6	14.57	37.19	21.24	12.52	6.38	0.94	29.02	18.07	4.58
6.8	14.63	36.96	21.15	13.45	6.24	0.96	28.88	17.92	4.47
7.0	14.69	36.89	21.97	14.34	6.21	0.96	29.38	17.58	4.45
7.2	14.72	36.56	22.39	15.65	6.02	0.97	30.81	17.45	4.31
7.4	14.75	36.53	24.94	16.93	6.03	0.98	29.25	17.80	4.25
7.6	14.76	36.40	27.93	19.10	5.99	0.98	28.57	16.36	4.20
7.8	14.75	36.35	33.77	21.29	6.01	0.99	28.25	17.82	4.19
8.0	14.74	36.30	44.19	25.61	6.01	0.99	28.00	17.58	4.19
8.2	14.69	36.39	33.39	33.75	6.12	0.99	27.87	17.81	4.18
8.3	14.68	36.23	29.04	41.01	6.01	0.99	27.85	17.77	4.19
8.4	14.63	36.56	25.86	34.88	6.26	1.00	28.06	17.76	4.16
8.8	14.50	36.38	21.05	21.53	6.17	0.99	27.62	18.08	4.24
8.9	14.46	36.28	20.21	20.07	6.10	0.99	27.48	17.64	4.30
9.0	14.40	36.18	19.63	18.58	6.04	0.99	27.39	18.02	4.31
9.1	14.36	36.30	18.94	17.69	6.13	0.99	27.62	18.01	4.28
9.2	14.29	36.39	17.71	16.70	6.18	0.99	27.53	18.60	4.29
9.3	14.24	36.37	17.03	15.65	6.15	0.98	27.64	17.95	4.29
9.6	14.05	36.76	15.97	14.41	6.48	0.98	27.18	18.49	4.42
9.7	13.99	36.75	15.28	13.87	6.47	0.98	27.20	18.89	4.42
9.8	13.89	36.87	15.00	13.31	6.58	0.97	27.41	18.20	4.43
9.9	13.90	36.74	15.13	13.01	6.46	0.97	27.04	18.51	4.45
10.0	13.87	36.50	14.73	12.80	6.27	0.97	27.15	18.69	4.44
10.5	13.59	36.78	13.13	11.56	6.48	0.96	26.88	19.10	4.61
11.0	13.37	36.62	11.81	10.88	6.34	0.96	26.54	19.35	4.75
11.5	13.18	36.52	10.96	10.41	6.25	0.97	26.03	19.05	4.79
12.0	13.00	36.27	10.38	10.02	6.07	0.97	25.66	18.74	4.91
12.5	12.89	36.15	9.93	9.93	5.99	0.97	25.38	19.15	5.01
13.0	12.79	35.85	9.56	9.77	5.76	0.98	25.14	18.72	5.17
13.5	12.76	35.20	9.77	9.81	5.39	0.98	25.11	19.45	5.22
14.0	12.86	34.98	10.37	10.15	5.30	0.98	27.99	19.49	5.25
14.5	13.04	34.39	11.70	10.43	4.99	0.96	25.06	19.49	5.26
15.0	13.33	33.80	13.83	11.39	4.73	0.96	24.26	19.97	5.35
15.5	13.54	33.05	16.50	12.31	4.39	0.95	26.16	20.00	5.23
16.0	13.70	32.65	17.83	13.31	4.21	0.96	24.17	20.15	5.26
16.5	13.75	32.25	16.28	15.85	4.07	0.98	24.06	20.21	5.29
17.0	13.56	31.98	13.43	14.68	3.93	0.99	23.96	19.93	5.33
17.5	13.15	31.97	10.79	13.29	3.93	1.01	23.19	18.80	5.63
18.0	12.62	32.20	9.09	11.54	4.02	1.02	24.16	18.21	5.93

Typical Performance Data

Definitions:

Input Return Loss = -S11 (dB)

Gain(Power Gain) = S21 (dB)

Reverse Isolation = -S12 (dB)

Output Return Loss = -S22 (dB)

TEST CONDITIONS: Vd = 4.75V, Id = 131.25mA @ Temperature = 25degC

FREQ	Gain	Isolation	Input Return Loss	Output Return Loss	Stability		IP-3 Output	1dB Comp. Output	Noise Figure
					K	Measure			
(GHz)	(dB)	(dB)	(dB)	(dB)	K	Measure	(dBm)	(dBm)	(dB)
5.0	13.06	41.12	11.77	7.80	9.96	0.88	33.38	16.71	7.17
5.2	13.50	40.11	13.84	8.50	8.90	0.89	30.58	17.35	6.48
5.4	13.84	39.48	16.15	9.30	8.32	0.90	31.18	17.35	5.96
5.6	14.08	38.90	18.57	9.80	7.76	0.90	32.19	17.62	5.56
5.8	14.26	38.53	20.96	10.44	7.43	0.91	37.51	17.18	5.26
6.0	14.41	38.01	22.27	10.92	6.97	0.92	30.91	17.39	5.03
6.2	14.52	37.71	22.25	11.61	6.73	0.93	37.74	17.30	4.81
6.4	14.62	37.46	21.75	12.06	6.51	0.94	29.88	17.44	4.65
6.6	14.69	37.22	21.46	12.61	6.33	0.95	29.71	17.45	4.55
6.8	14.74	36.92	21.29	13.54	6.14	0.96	29.94	17.29	4.50
7.0	14.80	36.89	22.09	14.43	6.13	0.96	33.18	16.93	4.51
7.2	14.84	36.57	22.45	15.79	5.95	0.97	34.06	16.83	4.31
7.4	14.86	36.61	25.08	17.05	6.02	0.98	33.14	17.16	4.23
7.6	14.88	36.38	27.88	19.25	5.91	0.98	30.98	16.71	4.20
7.8	14.87	36.34	33.16	21.44	5.92	0.99	28.86	17.17	4.17
8.0	14.86	36.32	49.36	25.90	5.94	0.99	28.52	16.94	4.14
8.2	14.81	36.44	33.89	34.64	6.07	0.99	28.65	17.18	4.17
8.3	14.80	36.28	29.25	47.90	5.96	0.99	28.75	17.13	4.13
8.4	14.76	36.52	26.34	35.06	6.15	1.00	29.59	17.14	4.11
8.8	14.63	36.37	21.28	21.73	6.07	0.99	28.74	17.43	4.20
8.9	14.60	36.21	20.48	20.15	5.96	0.99	28.54	17.00	4.24
9.0	14.52	36.25	19.86	18.70	6.01	0.99	28.03	17.36	4.27
9.1	14.50	36.24	19.09	17.76	5.99	0.99	28.97	17.34	4.26
9.2	14.43	36.33	17.92	16.78	6.05	0.99	27.85	17.94	4.27
9.3	14.38	36.35	17.21	15.73	6.06	0.98	29.09	17.30	4.25
9.6	14.20	36.65	16.08	14.52	6.31	0.98	27.96	17.83	4.37
9.7	14.15	36.65	15.42	13.94	6.29	0.98	27.60	18.23	4.38
9.8	14.03	36.92	15.14	13.38	6.52	0.97	28.81	17.53	4.40
9.9	14.06	36.61	15.27	13.05	6.26	0.97	27.43	17.86	4.40
10.0	14.03	36.46	14.86	12.93	6.15	0.97	28.08	18.04	4.39
10.5	13.76	36.69	13.25	11.69	6.32	0.96	27.56	18.46	4.54
11.0	13.55	36.62	11.95	11.05	6.24	0.97	26.98	18.38	4.69
11.5	13.37	36.41	11.11	10.50	6.07	0.97	26.33	18.43	4.82
12.0	13.20	36.18	10.49	10.10	5.91	0.97	25.88	18.11	4.87
12.5	13.10	36.00	10.05	10.01	5.77	0.97	25.57	18.52	4.94
13.0	13.02	35.78	9.69	9.82	5.60	0.98	25.32	18.07	5.07
13.5	13.00	35.07	9.94	9.88	5.20	0.97	25.36	18.82	5.11
14.0	13.11	34.96	10.51	10.20	5.17	0.97	27.12	18.87	5.23
14.5	13.29	34.27	11.88	10.49	4.81	0.96	25.64	18.84	5.24
15.0	13.58	33.62	14.06	11.41	4.52	0.96	25.07	19.37	5.30
15.5	13.80	32.79	16.78	12.31	4.15	0.95	25.33	19.40	5.21
16.0	13.96	32.65	18.15	13.44	4.10	0.96	24.69	19.58	5.20
16.5	14.02	32.14	16.62	16.19	3.91	0.98	24.44	19.65	5.27
17.0	13.84	31.94	13.64	14.90	3.81	0.99	24.04	19.63	5.30
17.5	13.41	31.88	10.88	13.27	3.78	1.00	24.37	18.14	5.59
18.0	12.86	32.15	9.14	11.48	3.90	1.01	25.06	17.54	5.90

Typical Performance Data

Definitions:

Input Return Loss = -S11 (dB)

Gain(Power Gain) = S21 (dB)

Reverse Isolation = -S12 (dB)

Output Return Loss = -S22 (dB)

TEST CONDITIONS: Vd = 5.25V, Id = 132.75mA @ Temperature = 25degC

FREQ (GHz)	Gain (dB)	Isolation (dB)	Input Return Loss (dB)	Output Return Loss (dB)	Stability		IP-3 Output (dBm)	1dB Comp. Output (dBm)	Noise Figure (dB)
					K	Measure			
5.0	12.80	41.17	11.80	7.75	10.30	0.88	29.67	17.64	7.22
5.2	13.25	40.19	13.88	8.44	9.22	0.88	29.13	18.22	6.54
5.4	13.60	39.54	16.23	9.21	8.59	0.89	29.60	18.29	6.04
5.6	13.85	38.94	18.73	9.72	7.99	0.90	29.91	18.58	5.63
5.8	14.04	38.57	21.00	10.33	7.64	0.91	29.44	18.29	5.33
6.0	14.18	38.07	22.29	10.80	7.18	0.92	29.66	18.47	5.10
6.2	14.29	37.74	21.99	11.47	6.91	0.93	28.52	18.44	4.88
6.4	14.40	37.48	21.57	11.89	6.67	0.94	28.44	18.59	4.72
6.6	14.47	37.19	21.09	12.44	6.44	0.94	28.69	18.62	4.62
6.8	14.53	37.02	21.14	13.37	6.35	0.95	28.49	18.47	4.50
7.0	14.59	36.88	21.91	14.25	6.27	0.96	28.23	18.14	4.40
7.2	14.62	36.57	22.41	15.57	6.10	0.97	28.45	18.00	4.37
7.4	14.64	36.50	24.98	16.81	6.09	0.98	27.91	18.36	4.28
7.6	14.66	36.40	28.09	18.97	6.07	0.98	27.71	17.92	4.22
7.8	14.65	36.34	34.37	21.12	6.07	0.99	28.06	18.38	4.23
8.0	14.64	36.29	40.22	25.29	6.07	0.99	27.82	18.14	4.18
8.2	14.58	36.43	32.75	32.64	6.23	0.99	27.60	18.39	4.19
8.3	14.57	36.23	28.61	37.16	6.08	0.99	27.55	18.33	4.25
8.4	14.52	36.57	25.53	34.14	6.35	1.00	27.51	18.35	4.21
8.8	14.38	36.39	20.89	21.41	6.25	0.99	27.19	18.67	4.25
8.9	14.34	36.29	19.98	19.93	6.19	0.99	27.10	18.25	4.31
9.0	14.27	36.24	19.42	18.52	6.17	0.99	27.14	18.61	4.34
9.1	14.23	36.37	18.73	17.64	6.25	0.99	27.08	18.61	4.30
9.2	14.16	36.44	17.61	16.67	6.31	0.99	27.47	19.16	4.34
9.3	14.11	36.39	16.91	15.59	6.26	0.98	26.99	18.54	4.32
9.6	13.92	36.82	15.80	14.34	6.62	0.98	26.90	19.10	4.44
9.7	13.85	36.77	15.16	13.79	6.57	0.98	27.09	19.47	4.44
9.8	13.76	36.81	14.89	13.19	6.62	0.97	26.76	18.80	4.43
9.9	13.76	36.79	14.96	12.93	6.58	0.97	26.94	19.11	4.47
10.0	13.74	36.55	14.60	12.71	6.40	0.97	26.75	19.26	4.48
10.5	13.44	36.88	13.02	11.48	6.64	0.96	26.63	19.65	4.62
11.0	13.21	36.66	11.73	10.79	6.46	0.96	26.43	19.55	4.72
11.5	13.00	36.55	10.85	10.34	6.37	0.97	25.98	19.58	4.83
12.0	12.81	36.35	10.27	9.93	6.23	0.97	25.67	19.30	4.94
12.5	12.69	36.23	9.78	9.87	6.14	0.98	25.34	19.69	5.02
13.0	12.59	35.93	9.42	9.72	5.91	0.98	25.14	19.29	5.18
13.5	12.55	35.26	9.67	9.75	5.54	0.98	25.06	19.94	5.30
14.0	12.65	35.04	10.28	10.10	5.45	0.98	25.05	19.98	5.29
14.5	12.82	34.50	11.58	10.36	5.17	0.96	25.22	19.97	5.32
15.0	13.11	33.98	13.64	11.28	4.93	0.96	23.97	20.41	5.38
15.5	13.32	33.22	16.23	12.19	4.58	0.95	25.52	20.46	5.29
16.0	13.47	32.71	17.51	13.13	4.34	0.96	23.99	20.61	5.31
16.5	13.51	32.31	16.05	15.69	4.20	0.98	24.10	20.65	5.34
17.0	13.32	32.05	13.31	14.72	4.07	0.99	26.34	20.47	5.40
17.5	12.92	32.04	10.71	13.39	4.05	1.01	22.91	19.38	5.63
18.0	12.39	32.25	9.02	11.62	4.14	1.02	24.05	18.79	5.97

Typical Performance Data

Definitions:

Input Return Loss = -S11 (dB)

Gain(Power Gain) = S21 (dB)

Reverse Isolation = -S12 (dB)

Output Return Loss = -S22 (dB)

TEST CONDITIONS: Vd = 5.00V, Id = 126.94mA @ Temperature = -45degC

FREQ (GHz)	Gain (dB)	Isolation (dB)	Input Return Loss (dB)	Output Return Loss (dB)	Stability		IP-3 Output (dBm)	1dB Comp. Output (dBm)	Noise Figure (dB)
					K	Measure			
5.0	14.34	40.89	11.10	7.50	8.19	0.87	31.49	17.17	6.20
5.2	14.74	39.99	13.00	8.29	7.51	0.88	32.40	17.73	5.54
5.4	15.06	39.39	15.07	9.14	7.09	0.89	31.80	17.84	5.04
5.6	15.28	38.82	17.47	9.78	6.67	0.90	31.17	18.09	4.67
5.8	15.44	38.51	19.60	10.34	6.46	0.91	32.07	17.76	4.35
6.0	15.57	38.00	21.32	10.93	6.09	0.92	32.51	17.98	4.19
6.2	15.67	37.69	21.61	11.51	5.88	0.93	35.90	17.97	3.94
6.4	15.78	37.48	21.78	12.01	5.72	0.93	34.66	18.11	3.77
6.6	15.84	37.22	21.25	12.64	5.55	0.94	34.06	18.18	3.70
6.8	15.90	36.94	21.49	13.26	5.39	0.95	34.38	18.00	3.57
7.0	15.96	36.87	21.73	14.40	5.37	0.96	34.92	17.70	3.49
7.2	16.00	36.58	22.33	15.24	5.22	0.97	35.85	17.61	3.41
7.4	16.03	36.55	23.85	16.85	5.23	0.97	38.98	17.95	3.39
7.6	16.06	36.44	26.18	18.42	5.19	0.98	39.82	17.41	3.33
7.8	16.07	36.36	29.73	20.90	5.17	0.98	36.44	17.88	3.32
8.0	16.07	36.35	34.06	24.39	5.19	0.99	35.88	17.63	3.25
8.2	16.04	36.39	35.75	29.89	5.25	0.99	36.09	17.89	3.27
8.3	16.04	36.16	34.25	33.36	5.12	0.99	38.38	17.81	3.26
8.4	16.00	36.50	29.31	31.11	5.33	0.99	36.85	17.68	3.25
8.8	15.89	36.47	23.35	22.03	5.34	0.99	38.02	17.95	3.34
8.9	15.87	36.23	21.96	20.51	5.18	0.99	35.69	17.42	3.36
9.0	15.81	36.20	21.00	19.17	5.18	0.99	36.26	18.01	3.37
9.1	15.81	36.16	20.57	18.13	5.14	0.98	37.28	18.09	3.34
9.2	15.73	36.17	19.25	17.11	5.15	0.98	35.74	18.58	3.35
9.3	15.70	36.32	18.29	16.30	5.23	0.98	37.51	17.96	3.38
9.6	15.55	36.53	17.01	14.87	5.38	0.97	36.49	18.39	3.45
9.7	15.49	36.69	16.22	14.51	5.47	0.98	35.65	18.79	3.44
9.8	15.42	36.64	15.56	13.85	5.44	0.97	36.01	18.25	3.45
9.9	15.42	36.47	15.54	13.37	5.31	0.97	35.35	18.74	3.51
10.0	15.42	36.36	15.44	13.12	5.23	0.96	36.47	18.87	3.50
10.5	15.15	36.53	13.43	11.82	5.32	0.96	35.28	19.24	3.61
11.0	15.04	36.47	12.04	11.25	5.23	0.96	33.78	18.97	3.70
11.5	14.88	36.13	10.98	10.51	4.97	0.96	32.70	19.03	3.74
12.0	14.77	36.02	10.29	10.15	4.86	0.96	31.75	18.65	3.87
12.5	14.72	35.78	9.84	10.04	4.70	0.97	30.79	19.18	3.94
13.0	14.70	35.51	9.59	10.02	4.53	0.98	30.35	18.64	4.04
13.5	14.76	34.71	10.08	10.01	4.15	0.96	30.15	19.36	4.10
14.0	14.88	34.50	11.22	10.15	4.09	0.95	30.12	19.38	4.13
14.5	15.10	33.90	13.00	10.30	3.83	0.93	29.52	19.30	4.18
15.0	15.42	33.27	15.43	11.05	3.56	0.93	28.43	20.01	4.24
15.5	15.66	32.48	19.32	11.69	3.26	0.92	28.50	20.07	4.13
16.0	15.93	31.86	21.69	13.19	3.05	0.93	27.90	20.08	4.08
16.5	16.06	31.54	19.20	14.22	2.92	0.94	27.76	20.33	4.17
17.0	16.01	31.20	15.37	13.16	2.78	0.94	26.95	19.43	4.23
17.5	15.69	31.14	11.90	11.76	2.73	0.94	27.01	18.70	4.36
18.0	15.19	31.39	9.22	9.74	2.72	0.95	26.95	18.28	4.71

Typical Performance Data

Definitions:

Input Return Loss = -S11 (dB)
 Gain(Power Gain) = S21 (dB)
 Reverse Isolation = -S12 (dB)
 Output Return Loss = -S22 (dB)

TEST CONDITIONS: Vd = 4.75V, Id = 124.70mA @ Temperature = -45degC

FREQ	Gain	Isolation	Input Return Loss	Output Return Loss	Stability		IP-3 Output	1dB Comp. Output	Noise Figure
					K	Measure			
(GHz)	(dB)	(dB)	(dB)	(dB)	K	Measure	(dBm)	(dBm)	(dB)
5.0	14.98	40.85	10.87	7.48	7.55	0.88	28.20	16.25	6.16
5.2	15.36	39.97	12.66	8.27	6.95	0.88	29.12	16.89	5.49
5.4	15.66	39.39	14.65	9.13	6.60	0.90	28.86	16.95	4.99
5.6	15.87	38.84	16.90	9.76	6.24	0.90	28.46	17.21	4.63
5.8	16.02	38.57	18.97	10.35	6.08	0.91	28.33	16.80	4.31
6.0	16.15	38.06	20.69	10.91	5.74	0.92	28.08	17.02	4.13
6.2	16.25	37.75	21.28	11.52	5.55	0.93	29.94	16.99	3.90
6.4	16.35	37.58	21.51	12.01	5.42	0.93	30.04	17.13	3.75
6.6	16.42	37.30	21.14	12.62	5.25	0.94	29.75	17.18	3.63
6.8	16.47	37.05	21.19	13.25	5.11	0.95	29.82	17.04	3.55
7.0	16.54	36.94	21.46	14.33	5.07	0.96	29.55	16.71	3.43
7.2	16.57	36.68	21.69	15.18	4.94	0.96	29.09	16.62	3.42
7.4	16.61	36.63	22.86	16.67	4.94	0.97	30.09	17.02	3.32
7.6	16.64	36.50	24.42	18.28	4.89	0.98	30.49	16.49	3.30
7.8	16.65	36.48	26.61	20.51	4.91	0.98	30.33	16.94	3.25
8.0	16.66	36.39	28.40	23.93	4.88	0.99	30.21	16.67	3.26
8.2	16.63	36.46	29.53	28.62	4.94	0.99	30.39	16.89	3.24
8.3	16.64	36.20	29.78	31.90	4.80	0.99	30.43	16.82	3.22
8.4	16.61	36.55	27.65	30.74	5.00	0.99	30.70	16.70	3.20
8.8	16.50	36.56	23.16	22.52	5.03	0.99	30.34	16.88	3.25
8.9	16.50	36.22	22.29	20.84	4.83	0.99	30.86	16.39	3.31
9.0	16.44	36.26	21.54	19.40	4.86	0.98	30.13	16.88	3.35
9.1	16.43	36.19	20.96	18.45	4.81	0.98	30.78	17.01	3.31
9.2	16.36	36.26	19.50	17.22	4.85	0.98	30.55	17.50	3.33
9.3	16.34	36.29	18.69	16.47	4.86	0.98	30.69	16.88	3.32
9.6	16.19	36.51	17.40	15.09	5.00	0.97	31.10	17.28	3.41
9.7	16.13	36.65	16.59	14.68	5.08	0.97	30.50	17.65	3.44
9.8	16.08	36.66	16.00	14.01	5.08	0.97	30.34	17.18	3.44
9.9	16.08	36.46	15.96	13.51	4.94	0.96	30.44	17.71	3.45
10.0	16.07	36.31	15.89	13.28	4.85	0.96	30.50	17.86	3.43
10.5	15.83	36.49	13.76	11.98	4.93	0.96	30.76	18.26	3.57
11.0	15.74	36.37	12.42	11.34	4.81	0.96	31.59	17.97	3.66
11.5	15.60	36.04	11.37	10.56	4.58	0.95	30.91	18.01	3.72
12.0	15.53	35.92	10.72	10.17	4.46	0.95	30.62	17.64	3.83
12.5	15.51	35.59	10.30	10.04	4.26	0.96	29.42	18.14	3.89
13.0	15.52	35.31	10.12	9.95	4.10	0.96	29.79	17.58	4.00
13.5	15.60	34.51	10.79	9.94	3.76	0.94	29.91	18.17	4.06
14.0	15.73	34.16	12.14	10.11	3.65	0.93	30.26	18.17	4.05
14.5	15.97	33.79	14.36	10.17	3.47	0.91	30.05	17.98	4.10
15.0	16.31	33.05	17.57	10.88	3.18	0.91	29.88	18.61	4.17
15.5	16.59	32.21	23.45	11.47	2.88	0.91	30.66	18.72	4.12
16.0	16.92	31.63	28.99	12.80	2.67	0.91	30.51	18.64	4.06
16.5	17.13	31.20	24.16	13.75	2.52	0.92	30.56	18.81	4.12
17.0	17.16	30.77	18.52	12.53	2.36	0.90	30.37	17.82	4.10
17.5	16.93	30.70	13.94	11.02	2.31	0.89	30.78	17.22	4.34
18.0	16.48	30.92	10.49	9.00	2.29	0.88	31.00	16.97	4.61

Typical Performance Data

Definitions:

Input Return Loss = -S11 (dB)

Gain(Power Gain) = S21 (dB)

Reverse Isolation = -S12 (dB)

Output Return Loss = -S22 (dB)

TEST CONDITIONS: Vd = 5.25V, Id = 128.59mA @ Temperature = -45degC

FREQ (GHz)	Gain (dB)	Isolation (dB)	Input Return Loss (dB)	Output Return Loss (dB)	Stability		IP-3 Output (dBm)	1dB Comp. Output (dBm)	Noise Figure (dB)
					K	Measure			
5.0	13.97	40.93	11.22	7.48	8.60	0.87	40.30	17.72	6.22
5.2	14.38	39.95	13.16	8.29	7.80	0.88	39.05	18.23	5.59
5.4	14.70	39.38	15.31	9.12	7.38	0.89	40.26	18.38	5.05
5.6	14.93	38.84	17.76	9.76	6.97	0.90	37.28	18.65	4.68
5.8	15.09	38.50	19.95	10.31	6.71	0.91	37.69	18.42	4.37
6.0	15.23	38.00	21.60	10.90	6.33	0.92	36.72	18.62	4.19
6.2	15.33	37.69	21.74	11.49	6.10	0.93	33.92	18.64	3.94
6.4	15.44	37.48	21.87	11.98	5.94	0.93	35.60	18.81	3.80
6.6	15.51	37.21	21.15	12.62	5.76	0.94	36.94	18.88	3.69
6.8	15.56	36.92	21.56	13.24	5.58	0.95	35.10	18.70	3.63
7.0	15.63	36.83	21.79	14.39	5.55	0.96	33.32	17.32	3.50
7.2	15.66	36.54	22.58	15.21	5.40	0.97	32.74	18.34	3.44
7.4	15.69	36.51	24.24	16.88	5.41	0.97	32.22	18.67	3.41
7.6	15.72	36.40	27.11	18.42	5.37	0.98	32.34	18.13	3.33
7.8	15.73	36.30	31.54	21.02	5.34	0.98	33.92	18.59	3.30
8.0	15.73	36.31	40.14	24.58	5.37	0.99	33.01	17.40	3.31
8.2	15.68	36.39	38.83	30.85	5.47	0.99	32.29	18.62	3.30
8.3	15.69	36.16	34.92	35.32	5.32	0.99	32.68	18.58	3.33
8.4	15.65	36.48	29.15	32.03	5.53	0.99	31.39	18.43	3.31
8.8	15.52	36.51	22.86	21.99	5.59	0.99	31.93	18.73	3.36
8.9	15.51	36.24	21.43	20.41	5.40	0.99	30.67	18.21	3.39
9.0	15.45	36.20	20.56	19.05	5.39	0.99	32.15	18.80	3.40
9.1	15.44	36.19	20.19	18.00	5.37	0.98	30.91	18.87	3.38
9.2	15.38	36.17	18.98	16.99	5.36	0.98	32.04	19.33	3.37
9.3	15.33	36.33	17.92	16.23	5.45	0.98	30.71	18.74	3.38
9.6	15.16	36.52	16.69	14.74	5.60	0.98	30.74	19.17	3.50
9.7	15.09	36.66	15.84	14.43	5.70	0.98	31.55	19.54	3.52
9.8	15.05	36.64	15.32	13.76	5.66	0.97	30.13	19.02	3.47
9.9	15.03	36.52	15.21	13.27	5.56	0.97	31.39	19.48	3.50
10.0	15.03	36.42	15.18	13.01	5.49	0.97	30.98	19.60	3.49
10.5	14.74	36.54	13.16	11.71	5.56	0.96	30.69	19.90	3.67
11.0	14.61	36.54	11.76	11.16	5.50	0.97	29.80	19.67	3.76
11.5	14.44	36.21	10.73	10.44	5.23	0.97	29.45	19.72	3.80
12.0	14.31	36.11	10.01	10.11	5.13	0.97	29.02	19.41	3.94
12.5	14.24	35.84	9.56	10.02	4.95	0.98	28.81	20.16	3.97
13.0	14.20	35.62	9.27	10.02	4.80	0.99	28.23	19.42	4.15
13.5	14.25	34.84	9.71	10.02	4.42	0.98	28.05	20.12	4.17
14.0	14.35	34.60	10.74	10.17	4.35	0.96	27.75	20.14	4.13
14.5	14.56	34.02	12.38	10.31	4.08	0.94	28.66	20.11	4.25
15.0	14.86	33.49	14.54	11.08	3.86	0.94	27.74	20.68	4.30
15.5	15.08	32.54	17.88	11.72	3.49	0.93	26.47	20.97	4.22
16.0	15.33	32.11	19.37	13.31	3.33	0.94	25.94	20.83	4.16
16.5	15.42	31.78	17.27	14.37	3.20	0.95	26.68	21.20	4.22
17.0	15.32	31.42	14.06	13.43	3.04	0.96	25.09	20.34	4.27
17.5	14.98	31.39	11.08	12.15	3.01	0.97	24.98	19.50	4.50
18.0	14.46	31.62	8.67	10.12	2.98	0.98	24.97	19.02	4.77

Typical Performance Data

Definitions:

Input Return Loss = -S11 (dB)

Gain(Power Gain) = S21 (dB)

Reverse Isolation = -S12 (dB)

Output Return Loss = -S22 (dB)

TEST CONDITIONS: Vd = 5.00V, Id = 132.70mA @ Temperature = 85degC

FREQ	Gain	Isolation	Input Return Loss	Output Return Loss	Stability		IP-3 Output	1dB Comp. Output	Noise Figure
					K	Measure			
(GHz)	(dB)	(dB)	(dB)	(dB)	K	Measure	(dBm)	(dBm)	(dB)
5.0	12.16	41.14	12.16	7.93	11.19	0.88	39.08	16.96	8.05
5.2	12.60	40.27	14.22	8.54	10.09	0.89	30.45	17.56	7.37
5.4	12.97	39.51	16.56	9.31	9.24	0.90	31.00	17.60	6.82
5.6	13.22	38.98	18.71	9.70	8.61	0.90	31.76	17.86	6.46
5.8	13.43	38.47	21.15	10.38	8.10	0.91	33.95	17.53	6.08
6.0	13.58	38.01	22.16	10.81	7.64	0.92	52.90	17.71	5.87
6.2	13.70	37.72	22.14	11.63	7.39	0.93	32.24	17.64	5.64
6.4	13.80	37.38	21.25	11.99	7.06	0.94	29.73	17.80	5.49
6.6	13.87	37.06	21.40	12.58	6.81	0.95	29.74	17.82	5.37
6.8	13.95	36.95	21.02	13.73	6.75	0.96	29.70	17.68	5.29
7.0	13.99	36.76	22.11	14.49	6.63	0.96	30.44	17.39	5.70
7.2	14.02	36.45	22.64	16.18	6.46	0.97	32.56	17.26	5.10
7.4	14.03	36.42	25.55	17.24	6.48	0.98	30.75	17.58	5.10
7.6	14.04	36.29	29.03	19.73	6.44	0.98	29.85	17.20	5.02
7.8	14.03	36.21	36.88	21.93	6.43	0.99	28.97	17.65	5.00
8.0	13.99	36.22	35.34	26.00	6.48	0.99	28.68	17.44	4.99
8.2	13.93	36.42	30.38	31.34	6.69	0.99	28.56	17.66	5.01
8.3	13.92	36.23	27.38	32.16	6.55	1.00	28.62	17.61	5.04
8.4	13.88	36.33	24.10	28.58	6.64	1.00	28.80	17.69	5.01
8.8	13.71	36.42	20.58	20.57	6.75	0.99	28.40	17.98	5.08
8.9	13.66	36.19	19.40	18.84	6.58	0.99	28.14	17.59	5.12
9.0	13.59	36.28	19.11	17.58	6.66	0.99	28.04	17.84	5.19
9.1	13.54	36.34	18.46	16.73	6.71	0.98	28.32	17.77	5.11
9.2	13.47	36.55	17.54	16.08	6.88	0.98	28.07	18.36	5.15
9.3	13.42	36.43	16.79	14.97	6.77	0.98	28.35	17.80	5.17
9.6	13.24	36.60	15.95	13.75	6.94	0.97	27.81	18.32	5.31
9.7	13.16	36.74	15.27	13.34	7.05	0.97	27.76	18.72	5.30
9.8	13.10	36.77	15.26	12.67	7.08	0.96	28.02	18.04	5.31
9.9	13.07	36.77	15.41	12.44	7.08	0.96	27.59	18.26	5.34
10.0	13.04	36.60	14.97	12.46	6.95	0.96	27.82	18.36	5.30
10.5	12.72	36.70	13.39	11.22	7.06	0.96	27.50	18.79	5.50
11.0	12.47	36.73	12.23	10.79	7.13	0.96	27.11	18.77	5.63
11.5	12.25	36.62	11.47	10.46	7.08	0.96	26.56	18.76	5.76
12.0	12.05	36.49	10.86	10.04	6.99	0.96	26.16	18.51	5.85
12.5	11.89	36.25	10.33	10.01	6.84	0.97	25.83	18.82	5.99
13.0	11.75	36.20	9.92	9.69	6.78	0.97	25.60	18.51	6.09
13.5	11.71	35.54	10.03	9.79	6.33	0.97	25.64	19.03	6.19
14.0	11.79	35.06	10.46	10.33	6.06	0.98	24.80	19.10	6.26
14.5	11.97	34.77	11.55	10.54	5.88	0.97	25.09	19.01	6.28
15.0	12.25	34.11	13.39	11.42	5.51	0.97	25.40	19.35	6.35
15.5	12.45	33.37	15.62	12.30	5.12	0.96	24.82	19.34	6.31
16.0	12.56	33.09	17.23	12.48	4.96	0.95	25.30	19.54	6.23
16.5	12.62	32.60	16.15	16.04	4.80	0.99	24.08	19.48	6.32
17.0	12.41	32.37	13.68	15.85	4.72	1.00	23.76	19.44	6.37
17.5	11.93	32.39	11.09	14.85	4.79	1.03	24.56	18.33	6.66
18.0	11.38	32.70	9.68	13.61	5.07	1.04	25.81	17.74	6.97

Typical Performance Data

Definitions:

Input Return Loss = -S11 (dB)

Gain(Power Gain) = S21 (dB)

Reverse Isolation = -S12 (dB)

Output Return Loss = -S22 (dB)

TEST CONDITIONS: Vd = 4.75V, Id = 132.35mA @ Temperature = 85degC

FREQ	Gain	Isolation	Input Return Loss	Output Return Loss	Stability		IP-3 Output	1dB Comp. Output	Noise Figure
					K	Measure			
(GHz)	(dB)	(dB)	(dB)	(dB)	K	Measure	(dBm)	(dBm)	(dB)
5.0	12.30	40.91	12.16	7.97	10.74	0.88	31.09	16.46	8.00
5.2	12.74	40.11	14.22	8.63	9.79	0.89	31.26	17.09	7.32
5.4	13.10	39.32	16.48	9.38	8.92	0.90	31.79	17.09	6.78
5.6	13.36	38.75	18.73	9.87	8.29	0.90	33.34	17.37	6.36
5.8	13.55	38.32	20.99	10.49	7.88	0.91	34.86	16.95	6.07
6.0	13.70	37.86	22.23	11.03	7.43	0.92	29.67	17.14	5.84
6.2	13.82	37.56	22.19	11.78	7.18	0.93	36.26	17.07	5.61
6.4	13.92	37.23	21.69	12.22	6.87	0.94	30.90	17.22	5.40
6.6	13.99	36.95	21.72	12.86	6.66	0.95	30.41	17.25	5.32
6.8	14.07	36.92	21.61	14.02	6.66	0.96	30.70	17.07	5.20
7.0	14.11	36.68	22.48	14.89	6.51	0.97	34.56	16.79	5.12
7.2	14.14	36.46	23.35	16.53	6.40	0.98	32.59	16.65	5.09
7.4	14.15	36.37	26.04	17.91	6.38	0.98	33.60	16.99	5.01
7.6	14.16	36.23	29.78	20.32	6.32	0.99	32.47	16.59	4.95
7.8	14.15	36.05	37.53	23.17	6.23	0.99	29.59	17.07	4.96
8.0	14.12	36.24	37.23	28.13	6.41	0.99	29.22	16.84	4.92
8.2	14.07	36.29	30.35	41.19	6.49	0.99	29.33	17.05	4.94
8.3	14.07	36.09	27.63	36.35	6.34	1.00	29.60	17.02	4.99
8.4	14.05	35.91	25.03	28.82	6.21	0.99	30.21	17.06	4.95
8.8	13.88	36.17	20.83	20.23	6.43	0.99	29.61	17.32	4.99
8.9	13.84	36.08	19.87	18.96	6.37	0.99	29.21	16.93	5.05
9.0	13.77	36.19	19.44	17.74	6.47	0.99	28.81	17.18	5.12
9.1	13.72	36.26	18.73	16.72	6.52	0.98	29.68	17.13	5.06
9.2	13.67	36.32	17.96	15.94	6.56	0.98	28.44	17.72	5.09
9.3	13.62	36.18	17.22	14.95	6.44	0.98	29.86	17.14	5.07
9.6	13.46	36.34	16.31	13.73	6.58	0.97	28.67	17.66	5.22
9.7	13.37	36.44	15.59	13.33	6.67	0.97	28.26	18.03	5.20
9.8	13.34	36.37	15.52	12.81	6.60	0.96	29.44	17.34	5.25
9.9	13.30	36.50	15.55	12.66	6.71	0.96	28.09	17.58	5.26
10.0	13.27	36.51	15.29	12.59	6.73	0.96	28.87	17.71	5.25
10.5	13.00	36.46	13.80	11.21	6.68	0.95	28.28	18.12	5.41
11.0	12.79	36.51	12.61	10.80	6.75	0.95	27.70	18.13	5.55
11.5	12.61	36.34	11.74	10.51	6.63	0.96	26.99	18.10	5.63
12.0	12.42	36.19	10.98	10.20	6.52	0.96	26.51	17.86	5.78
12.5	12.29	36.01	10.40	10.18	6.40	0.97	26.12	18.16	5.86
13.0	12.18	35.81	9.95	9.93	6.23	0.98	25.90	17.83	6.06
13.5	12.18	35.23	10.12	10.05	5.85	0.98	25.99	18.39	6.09
14.0	12.29	34.98	10.52	10.56	5.72	0.98	25.12	18.44	6.14
14.5	12.47	34.31	11.60	10.94	5.32	0.98	25.98	18.31	6.18
15.0	12.77	33.61	13.29	12.16	4.96	0.98	25.99	18.70	6.27
15.5	12.97	33.05	15.27	13.13	4.69	0.97	26.38	18.68	6.20
16.0	13.09	32.64	16.99	13.40	4.49	0.96	25.65	18.92	6.14
16.5	13.09	32.54	16.38	16.32	4.54	0.99	24.46	18.86	6.18
17.0	12.82	32.25	14.01	14.73	4.43	0.99	23.96	18.75	6.26
17.5	12.28	32.36	11.04	14.16	4.56	1.02	25.22	17.66	6.53
18.0	11.61	32.73	9.41	13.02	4.89	1.04	26.41	17.33	6.87

Typical Performance Data

Definitions:

Input Return Loss = -S11 (dB)

Gain(Power Gain) = S21 (dB)

Reverse Isolation = -S12 (dB)

Output Return Loss = -S22 (dB)

TEST CONDITIONS: Vd = 5.25V, Id = 133.22mA @ Temperature = 85degC

FREQ (GHz)	Gain (dB)	Isolation (dB)	Input Return Loss (dB)	Output Return Loss (dB)	Stability		IP-3 Output (dBm)	1dB Comp. Output (dBm)	Noise Figure (dB)
					K	Measure			
5.0	11.97	41.23	12.19	7.87	11.53	0.88	31.84	17.38	8.11
5.2	12.42	40.37	14.31	8.48	10.41	0.88	30.09	17.98	7.41
5.4	12.80	39.60	16.60	9.19	9.49	0.89	30.63	18.04	6.89
5.6	13.06	39.02	18.79	9.62	8.80	0.90	31.14	18.32	6.43
5.8	13.27	38.50	21.06	10.22	8.25	0.91	31.06	18.05	6.17
6.0	13.42	38.02	21.92	10.68	7.76	0.91	31.74	18.21	5.92
6.2	13.55	37.74	21.83	11.44	7.52	0.93	29.88	18.16	5.70
6.4	13.65	37.39	21.14	11.80	7.17	0.94	29.29	18.33	5.53
6.6	13.72	37.05	21.22	12.42	6.90	0.94	29.50	18.36	5.43
6.8	13.79	36.98	21.03	13.51	6.88	0.96	29.31	18.24	5.31
7.0	13.84	36.79	22.06	14.32	6.76	0.96	29.22	17.93	5.78
7.2	13.86	36.48	22.80	15.88	6.59	0.97	29.69	17.83	5.21
7.4	13.88	36.43	25.77	17.04	6.60	0.98	29.03	18.15	5.13
7.6	13.88	36.34	29.22	19.32	6.59	0.98	28.70	17.77	5.06
7.8	13.87	36.17	37.10	21.46	6.50	0.99	28.73	18.22	5.05
8.0	13.83	36.29	33.03	25.09	6.65	0.99	28.49	18.01	5.05
8.2	13.77	36.34	28.98	29.10	6.74	0.99	28.30	18.22	5.08
8.3	13.75	36.26	26.20	29.48	6.69	1.00	28.25	18.17	5.07
8.4	13.72	36.24	23.50	26.92	6.69	1.00	28.22	18.25	5.06
8.8	13.53	36.48	20.08	19.92	6.93	0.99	27.90	18.54	5.17
8.9	13.48	36.27	19.10	18.55	6.76	0.99	27.74	18.19	5.22
9.0	13.42	36.34	18.79	17.43	6.83	0.99	27.72	18.42	5.24
9.1	13.36	36.42	18.20	16.46	6.90	0.98	27.74	18.39	5.21
9.2	13.29	36.43	17.29	15.63	6.91	0.98	27.97	18.94	5.20
9.3	13.23	36.41	16.56	14.69	6.87	0.98	27.72	18.42	5.26
9.6	13.04	36.65	15.73	13.47	7.11	0.97	27.48	18.93	5.36
9.7	12.96	36.78	15.12	13.06	7.22	0.97	27.58	19.27	5.38
9.8	12.90	36.74	15.02	12.50	7.18	0.96	27.34	18.65	5.43
9.9	12.86	36.79	15.10	12.32	7.24	0.96	27.40	18.84	5.37
10.0	12.83	36.77	14.78	12.28	7.23	0.96	27.33	18.98	5.38
10.5	12.50	36.75	13.33	10.95	7.23	0.95	27.17	19.32	5.57
11.0	12.23	36.83	12.16	10.50	7.35	0.96	26.87	19.34	5.68
11.5	12.00	36.67	11.36	10.21	7.28	0.96	26.41	19.31	5.79
12.0	11.78	36.59	10.70	9.89	7.24	0.96	26.05	19.09	5.93
12.5	11.61	36.45	10.14	9.90	7.16	0.97	25.71	19.36	6.04
13.0	11.46	36.26	9.72	9.63	7.01	0.98	25.51	19.07	6.21
13.5	11.41	35.65	9.83	9.73	6.59	0.98	25.50	19.55	6.31
14.0	11.48	35.36	10.25	10.21	6.45	0.98	24.82	19.61	6.36
14.5	11.65	34.84	11.34	10.50	6.12	0.97	24.77	19.54	6.42
15.0	11.94	34.28	13.06	11.46	5.79	0.97	25.24	19.86	6.47
15.5	12.14	33.40	15.23	12.33	5.31	0.97	24.56	19.84	6.38
16.0	12.25	33.22	16.76	12.55	5.21	0.96	24.48	20.07	6.36
16.5	12.30	32.74	16.09	15.57	5.04	0.99	24.06	20.00	6.40
17.0	12.09	32.50	13.78	15.06	4.93	1.00	23.88	20.00	6.52
17.5	11.63	32.50	11.12	14.36	4.99	1.02	24.48	18.92	6.79
18.0	11.10	32.68	9.69	13.35	5.21	1.04	25.73	18.35	7.11

Typical Performance Curves

GAIN vs. FREQUENCY & TEMPERATURE
INPUT POWER = -25dBm, Vd = 5V

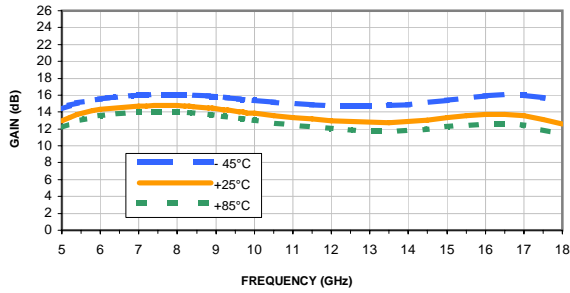

GAIN vs. FREQUENCY & DEVICE VOLTAGE
INPUT POWER = -25dBm, Temperature = +25°C

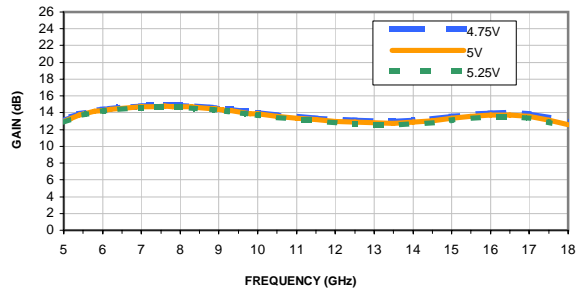

ISOLATION vs. FREQUENCY & TEMPERATURE
INPUT POWER = -25dBm, Vd = 5V

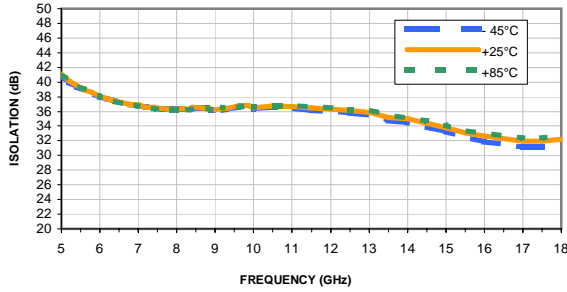

ISOLATION vs. FREQUENCY & DEVICE VOLTAGE
INPUT POWER = -25dBm, Temperature = +25°C

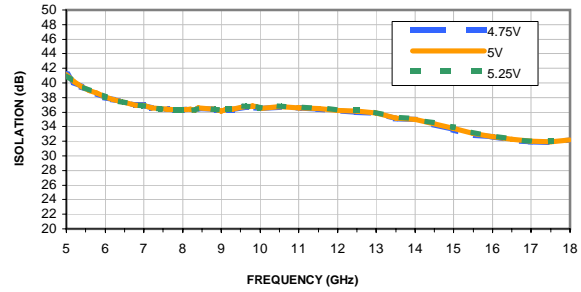

INPUT RETURN LOSS vs. FREQUENCY & TEMPERATURE
INPUT POWER = -25dBm, Vd = 5V

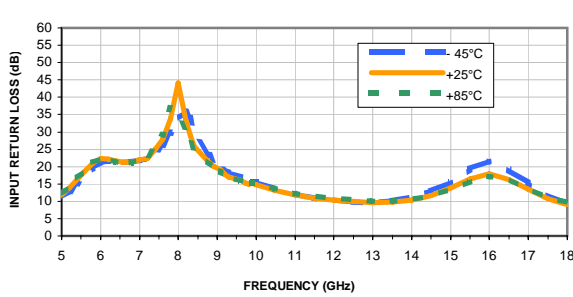

INPUT RETURN LOSS vs. FREQUENCY & DEVICE VOLTAGE
INPUT POWER = -25dBm, Temperature = +25°C

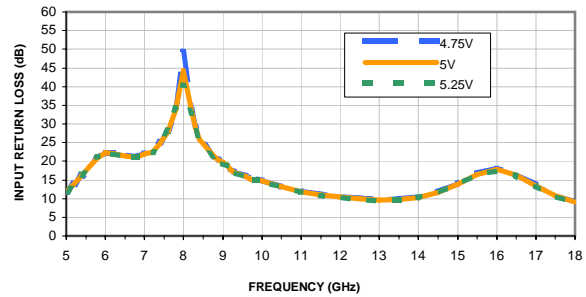

OUTPUT RETURN LOSS vs. FREQUENCY & TEMPERATURE
INPUT POWER = -25dBm, Vd = 5V

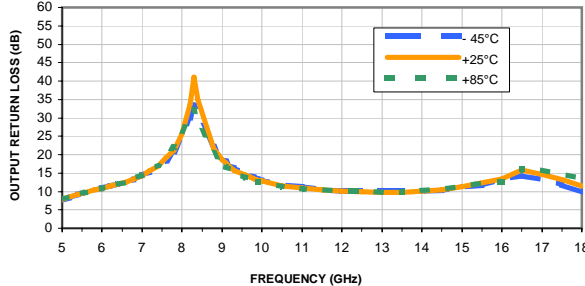

OUTPUT RETURN LOSS vs. FREQUENCY & DEVICE VOLTAGE
INPUT POWER = -25dBm, Temperature = +25°C

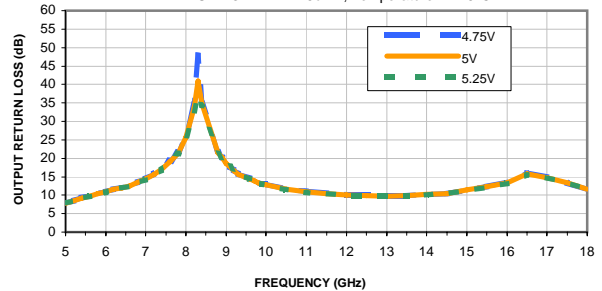

Typical Performance Curves

OUTPUT IP3 vs. FREQUENCY & TEMPERATURE
OUTPUT POWER = 5 dBm/tone, Vd = 5V

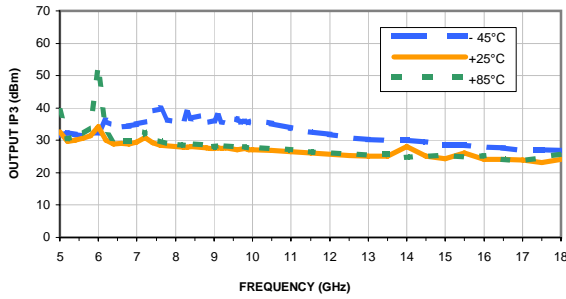

OUTPUT IP3 vs. FREQUENCY & DEVICE VOLTAGE
OUTPUT POWER = 5 dBm/tone, Temperature = +25°C

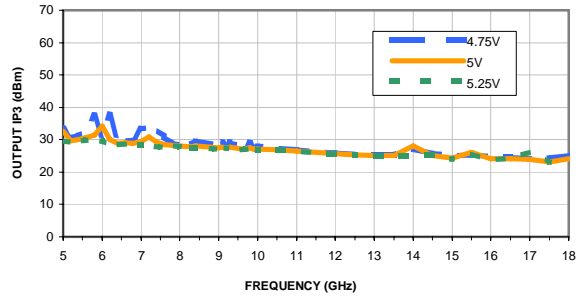

P1dB vs. FREQUENCY & TEMPERATURE
Vd = 5V

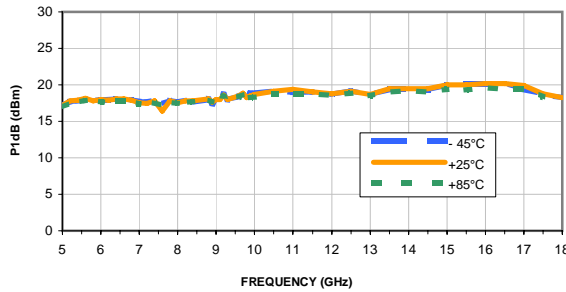

P1dB vs. FREQUENCY & DEVICE VOLTAGE
Temperature = +25°C

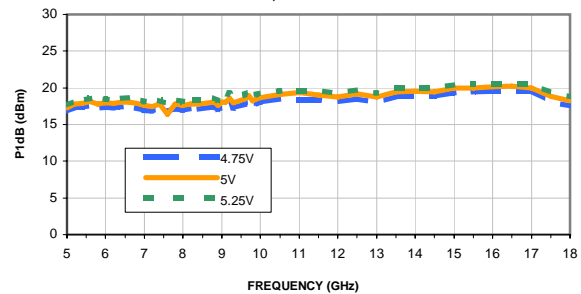

NOISE FIGURE vs. FREQUENCY & TEMPERATURE
Vd = 5V

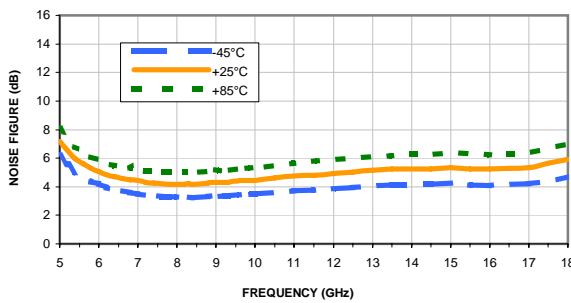

NOISE FIGURE vs. FREQUENCY & DEVICE VOLTAGE
Temperature = +25°C

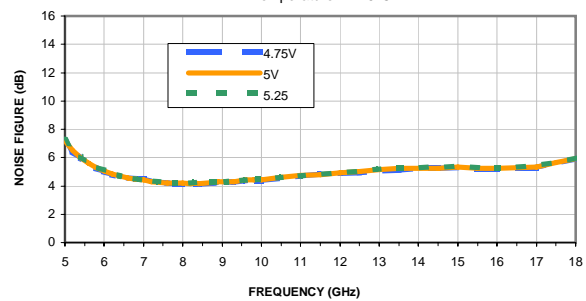

GAIN VARIATION vs. FREQUENCY & TEMPERATURE
INPUT POWER = -25dBm, Vd = 5V

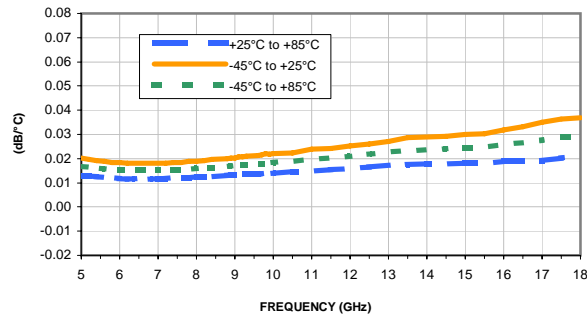

Outline Dimensions

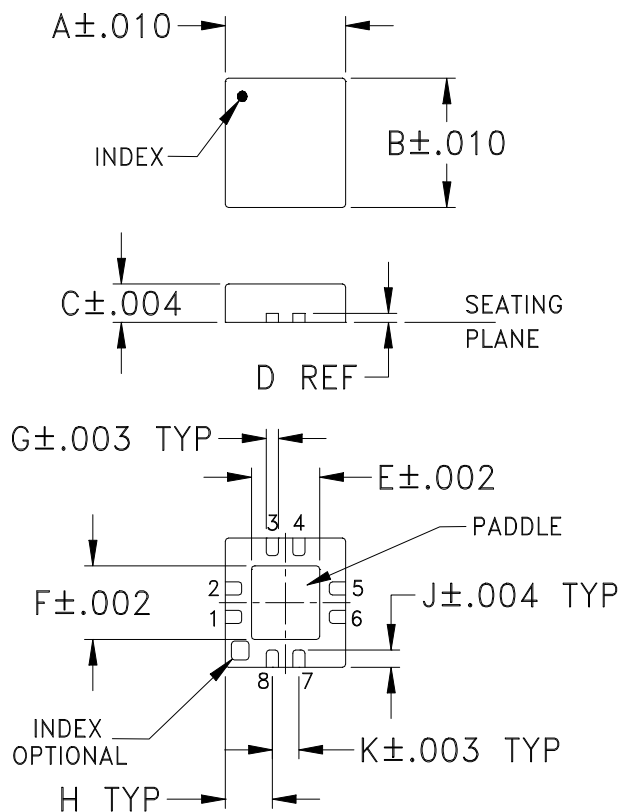

PCB Land Pattern

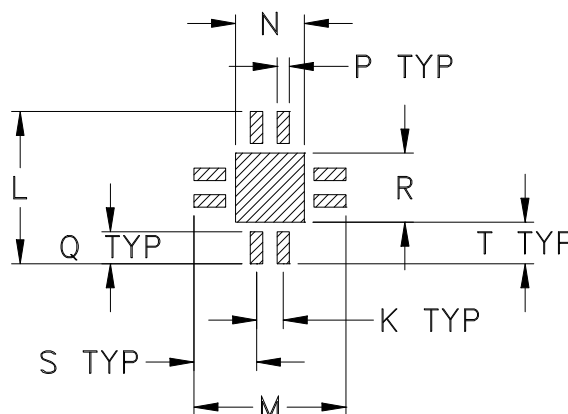

Suggested Layout,
Tolerance to be within $\pm.002$

CASE #	A	B	C	D	E	F	G	H	J	K	L	M	N
DQ849	.118 (3.00)	.118 (3.00)	.035 (0.89)	.008 (0.20)	.067 (1.70)	.067 (1.70)	.012 (0.30)	.046 (1.17)	.016 (0.41)	.026 (0.66)	.148 (3.76)	.148 (3.76)	.067 (1.70)

CASE #	P	Q	R	S	T	WT. GRAM
DQ849	.012 (0.30)	.031 (0.79)	.067 (1.70)	.061 (1.55)	.041 (1.04)	.02

Dimensions are in inches (mm). Tolerances: 2Pl. $\pm.01$; 3 Pl. $\pm.004$

Notes:

- Case material: Plastic.
- Termination finish:
 For RoHS Case Styles: Tin-Silver alloy plate over Nickel barrier or Matte-Tin plated. All models, (+) suffix. See Data sheet.
 For RoHS-5 Case Styles: Tin-Lead plate. All models. no (+) suffix.



INTERNET <http://www.minicircuits.com>

P.O. Box 350166, Brooklyn, New York 11235-0003 (718) 934-4500 Fax (718) 332-4661

Distribution Centers NORTH AMERICA 800-654-7949 • 417-335-5935 • Fax 417-335-5945 • EUROPE 44-1252-832600 • Fax 44-1252-837010

Mini-Circuits ISO 9001 & ISO 14001 Certified

Tape & Reel Packaging TR-F104

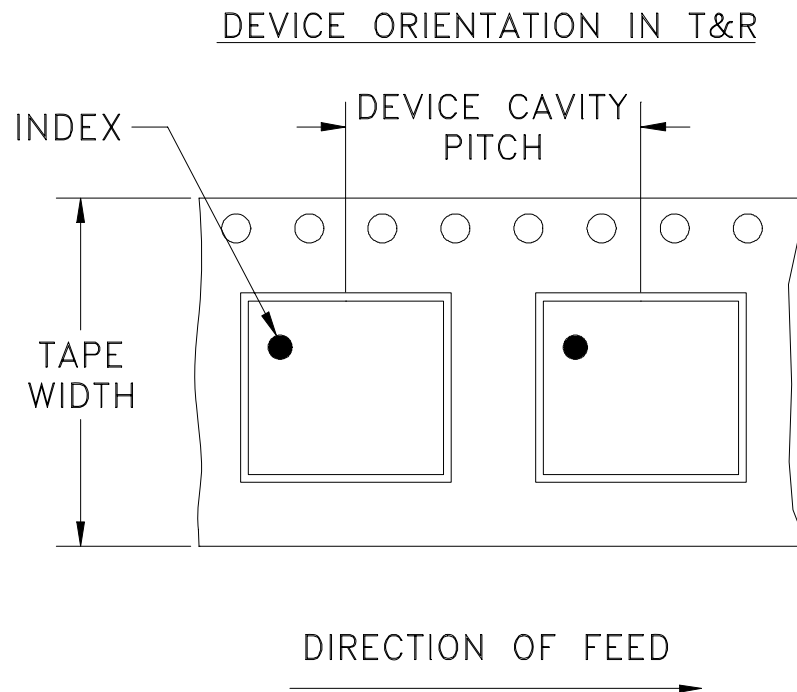

Tape Width, mm	Device Cavity Pitch, mm	Reel Size, inches	Devices per Reel	
8	4	7	Small quantity standards (see note)	20
				50
				100
				200
				500
				1000
		7	Standard	2000

Note: Please Consult individual model data sheet to determine device per reel availability.

Mini-Circuits carrier tape materials provide protection from ESD (Electro-Static Discharge) during handling and transportation. Tapes are static dissipative and comply with industry standards EIA-481/EIA-541.

Go to: www.minicircuits.com/pages/pdfs/tape.pdf



INTERNET <http://www.minicircuits.com>

P.O. Box 350166, Brooklyn, New York 11235-0003 (718) 934-4500 Fax (718) 332-4661

Distribution Centers NORTH AMERICA 800-654-7949 • 417-335-5935 • Fax 417-335-5945 • EUROPE 44-1252-832600 • Fax 44-1252-837010

Mini-Circuits ISO 9001 & ISO 14001 Certified

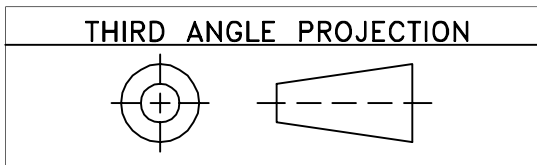

REVISIONS					
REV	ECN No.	DESCRIPTION	DATE	DR	AUTH
OR	M125952	NEW RELEASE	01/08/10	MMG	RD
A	M132664	UPDATED PATTERN & COMPONENTS	12/16/11	PW	DJ
B	M135298	UPDATED DESCRIPTION & NOTE 2	01/11/12	AV	DJ

**SUGGESTED MOUNTING CONFIGURATION FOR
DQ849 CASE STYLE, "08AM03" PIN CODE**

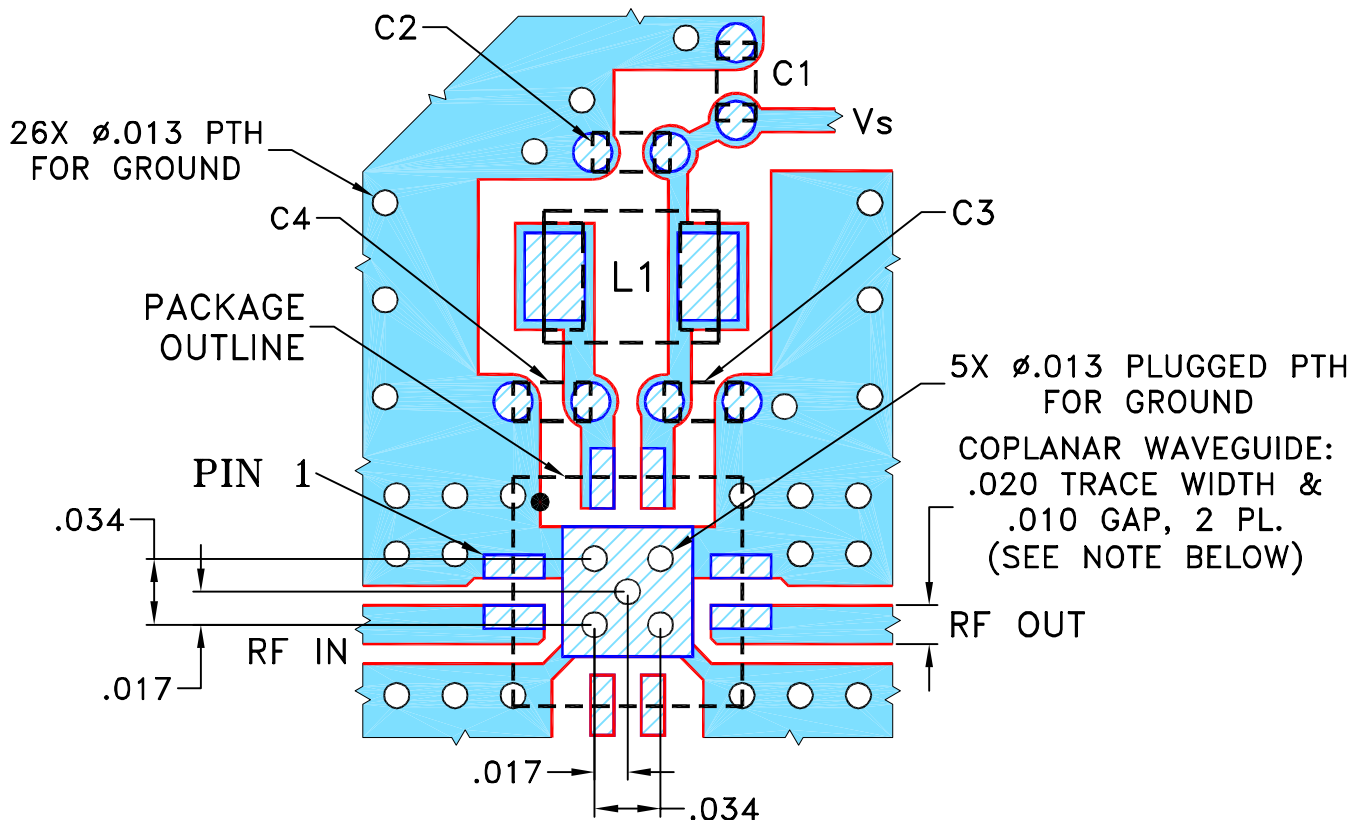

- NOTES: 1. COPLANAR WAVEGUIDE PARAMETERS ARE SHOWN FOR ROGERS RO4350B WITH DIELECTRIC THICKNESS .010" ± .001"; COPPER: 1/2 OZ. EACH SIDE.
FOR OTHER MATERIALS TRACE WIDTH MAY NEED TO BE MODIFIED.
2. 0402 AND 0805 CHIP COMPONENTS FOOTPRINTS ARE SHOWN FOR REFERENCE. VALUE OF COMPONENTS AS PER TB-547-X+.
3. BOTTOM SIDE OF THE PCB IS CONTINUOUS GROUND PLANE.

 DENOTES PCB COPPER LAYOUT WITH SMOBC (SOLDER MASK OVER BARE COPPER)

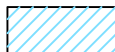
 DENOTES COPPER LAND PATTERN FREE OF SOLDER MASK

UNLESS OTHERWISE SPECIFIED	INITIALS	DATE
DIMENSIONS ARE IN INCHES	DRAWN MMG	01/06/10
TOLERANCES ON:	CHECKED IL	01/08/10
2 PL DECIMALS ±	APPROVED RD	01/08/10
3 PL DECIMALS ± .005		
ANGLES ±		
FRACTIONS ±		

 **Mini-Circuits®** 13 Neptune Avenue
Brooklyn NY 11235

PL, 08AM03, DQ849, TB-547-X+

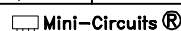
 Mini-Circuits®

THIS DOCUMENT AND ITS CONTENTS ARE THE PROPERTY OF MINI-CIRCUITS. EXCEPT FOR USE EXPRESSLY GRANTED, IN WRITING, TO ITS VENDORS, VENDEE AND THE UNITED STATES GOVERNMENT, MINI-CIRCUITS RESERVES ALL PROPRIETARY DESIGN, USE, MANUFACTURING AND REPRODUCTION RIGHTS THERE TO. THESE CONTENTS SHALL NOT BE USED, DUPLICATED OR DISCLOSED TO ANY OUTSIDE PARTY, IN WHOLE OR IN PART, WITHOUT WRITTEN PERMISSION OF MINI-CIRCUITS.

ASHEETA1.DWG REV:A DATE:01/12/95

SIZE	CODE IDENT	DRAWING NO:	REV:
A	15542	98-PL-328	B
FILE:	98PL328	SCALE: 10:1	SHEET: 1 OF 1

Evaluation Board and Circuit

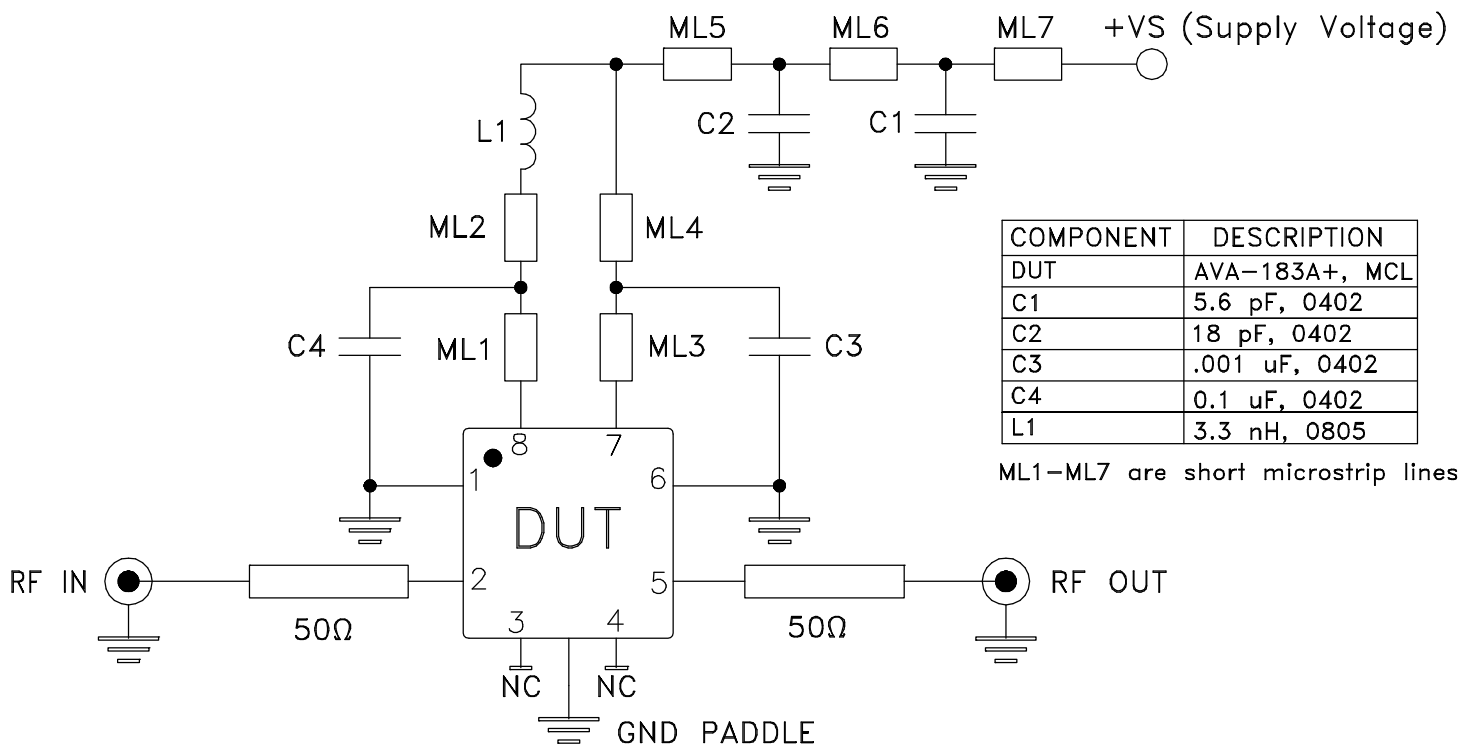
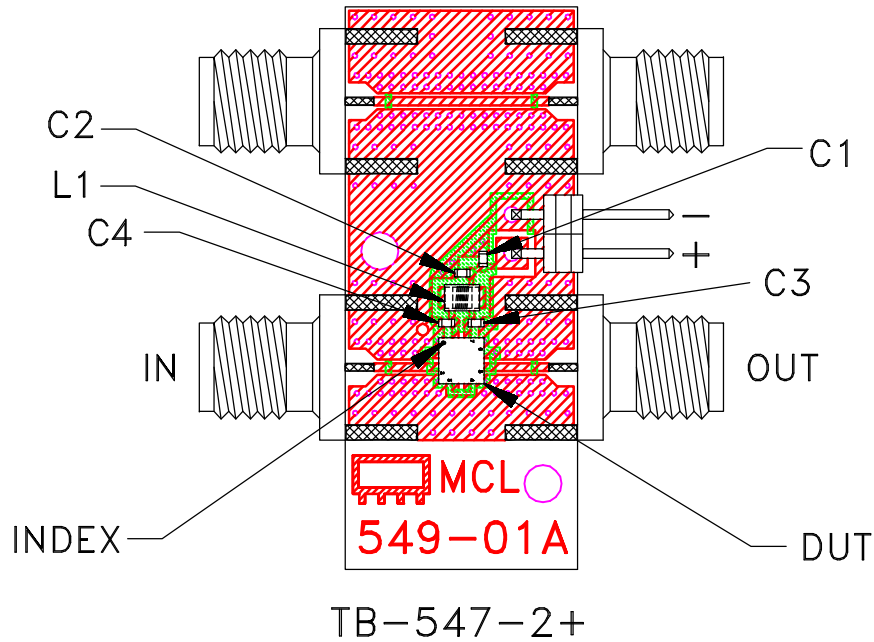

Schematic Diagram

NOTES:

1. SMA Female connectors.
2. PCB material: Rogers R04350 or equivalent, dielectric constant=3.5, dielectric thickness=.010 inch.

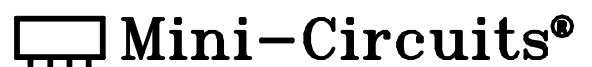

All Mini-Circuits products are manufactured under exacting quality assurance and control standards, and are capable of meeting published specifications after being subjected to any or all of the following physical and environmental test.

Specification	Test/Inspection Condition	Reference/Spec
Operating Temperature	-40° to 85° C or -45° to 85° C or -55° to 105° C or -40° to 105° C or -40° to 95° C Ambient Environment	Individual Model Data Sheet
Storage Temperature	-55° to 100° C or -65° to 150° Ambient Environment	Individual Model Data Sheet
HTOL	1000 hours at 125°C	MIL-STD-883, Method 1005, Condition B
Thermal Shock	-55° to 100°C, 100 cycles	MIL-STD-202, Method 107, Condition A-3, except +100°C
Mechanical Shock	1.5Kg, 0.5 ms, 5 shock pulses, Y1 direction only	MIL-STD-883, Method 2002, Condition B, except Y1 direction only
Vibration (Variable Frequency)	50g peak	MIL-STD-883, Method 2007, Condition B
Autoclave	15 psig, 100% RH, 121°C, 96 hours	JESD22-A102, Condition C
HAST	130°C, 85% RH, 96 hours	JESD22-A110
Solderability	10X Magnification	J-STD-002, Para 4.2.5, Test S, 95% Coverage
Solder Reflow Heat	Sn-Pb Eutetic Process: 240°C peak Pb-Free Process: 260°C peak	J-STD-020, Table 4-1, 4-2 and 5-2; Figure 5-1
Moisture Sensitivity: Level 1	Bake at 125°C for 24 hours Soak at 85°C/85% RH for 168 hours, Reflow 3 cycles at 260°C peak	J-STD-020



All Mini-Circuits products are manufactured under exacting quality assurance and control standards, and are capable of meeting published specifications after being subjected to any or all of the following physical and environmental test.

Specification	Test/Inspection Condition	Reference/Spec
Marking Resistance to Solvents	Isopropyl alcohol + mineral spirits at 25°C; terpene defluxer at 25°C; distilled water + proylene glycol monomethyl ether + monoethanolamine at 63°C to 70°C	MIL-STD-202, Method 215