

# Plug-In Low Noise Amplifier

## AMP-77+

50Ω

5 MHz to 500 MHz

### Features

- low noise, 3.3 dB typ.
- high IP3, +32 dBm typ.
- hermetic, TO-8 can

### Applications

- military, hi-rel applications
- small signal amplifier
- VHF/UHF



Generic photo used for illustration purposes only

CASE STYLE: PP120

**+RoHS Compliant**

The +Suffix identifies RoHS Compliance. See our web site for RoHS Compliance methodologies and qualifications

### Low Noise Amplifier Electrical Specifications

MODEL NO.	FREQUENCY (MHz)		NOISE FIGURE (dB)	GAIN (dB)			MAXIMUM POWER (dBm)		INTERCEPT POINT (dBm)	VSWR (:1) Typ.		DC POWER	
	f <sub>L</sub>	f <sub>U</sub>		Typ.	Min.	m	Total Range	Output (1 dB Compr.)		Input (no damage)	IP3 Typ.	In	Out
AMP-77+	5	500	3.3	15	±0.4	±1.0	+16	+13	+32	2.0	2.0	15	56

m = mid range [2 f<sub>L</sub> to f<sub>U</sub>/2]

Open load is not recommended, potentially can cause damage.  
With no load derate max input power by 20 dB

### Pin Connections

RF IN	2
RF OUT	4
DC	1
GROUND	3
CASE GROUND	3

### Maximum Ratings

Operating Temperature	-54°C to 85°C
Storage Temperature	-55°C to 100°C
DC Voltage	+17V Max.

Permanent damage may occur if any of these limits are exceeded.

### Outline Drawing

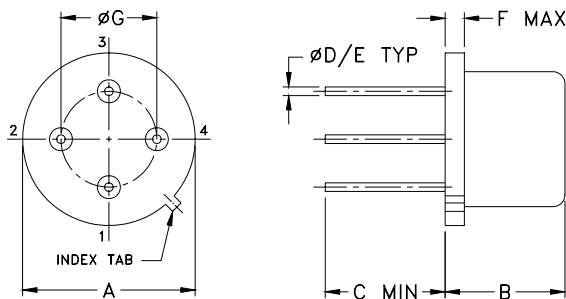

### Outline Dimensions (inch/mm)

A	B	C	D	E	F	G	wt
.50	.21	.15	.016	.020	.04	.300	grams
12.70	5.33	3.81	0.41	0.51	1.02	7.62	1.5

### Notes

- Performance and quality attributes and conditions not expressly stated in this specification document are intended to be excluded and do not form a part of this specification document.
- Electrical specifications and performance data contained in this specification document are based on Mini-Circuit's applicable established test performance criteria and measurement instructions.
- The parts covered by this specification document are subject to Mini-Circuits standard limited warranty and terms and conditions (collectively, "Standard Terms"); Purchasers of this part are entitled to the rights and benefits contained therein. For a full statement of the Standard Terms and the exclusive rights and remedies thereunder, please visit Mini-Circuits' website at [www.minicircuits.com/MCLStore/terms.jsp](http://www.minicircuits.com/MCLStore/terms.jsp)



[www.minicircuits.com](http://www.minicircuits.com) P.O. Box 350166, Brooklyn, NY 11235-0003 (718) 934-4500 sales@minicircuits.com

REV. B  
M151107  
AMP-77+  
200819  
Page 1 of 2

FREQUENCY (MHz)	GAIN (dB)			DIRECTIVITY (dB)			VSWR (:1)		NOISE FIGURE (dB)	P <sub>OUT</sub> at 1 dB COMPR. (dBm)
	12V	15V	16V	12V	15V	16V	IN	OUT		
5.00	16.26	16.25	16.23	5.00	5.00	5.10	1.49	1.57	—	18.30
11.30	16.55	16.58	16.55	4.30	4.30	4.30	1.25	1.25	3.30	18.96
33.40	16.75	16.79	16.76	3.80	3.80	3.80	1.13	1.09	3.27	19.66
98.80	16.74	16.77	16.76	3.50	3.50	3.50	1.11	1.16	3.30	19.68
195.40	16.55	16.59	16.57	2.90	3.00	3.00	1.13	1.35	3.24	19.62
246.20	16.43	16.47	16.46	2.50	2.70	2.70	1.15	1.41	3.24	19.49
309.60	16.27	16.32	16.28	2.20	2.30	2.40	1.18	1.47	3.27	19.24
373.10	16.13	16.19	16.14	1.80	1.90	2.00	1.21	1.45	3.25	19.08
436.50	16.04	16.08	16.04	1.40	1.60	1.70	1.23	1.44	3.26	19.11
500.00	15.92	15.98	15.93	1.10	1.30	1.40	1.24	1.36	3.28	19.25

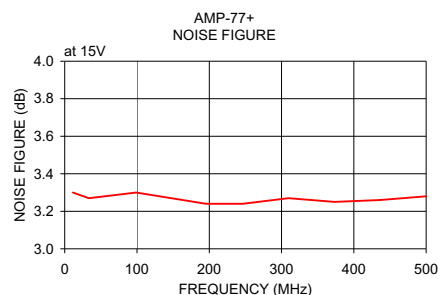
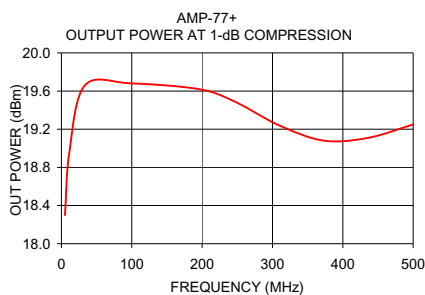
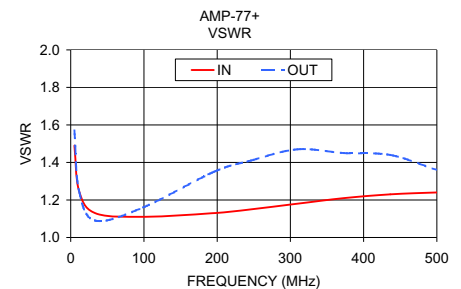
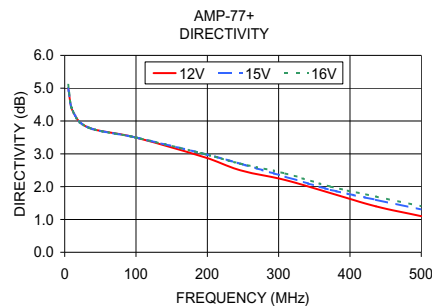
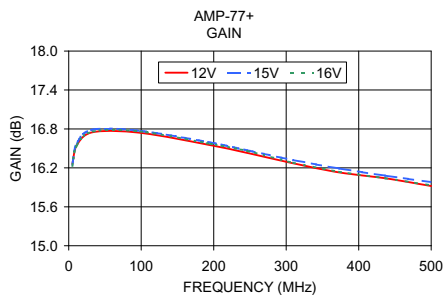

**Notes**

- A. Performance and quality attributes and conditions not expressly stated in this specification document are intended to be excluded and do not form a part of this specification document.
- B. Electrical specifications and performance data contained in this specification document are based on Mini-Circuit's applicable established test performance criteria and measurement instructions.
- C. The parts covered by this specification document are subject to Mini-Circuits standard limited warranty and terms and conditions (collectively, "Standard Terms"); Purchasers of this part are entitled to the rights and benefits contained therein. For a full statement of the Standard Terms and the exclusive rights and remedies thereunder, please visit Mini-Circuits' website at [www.minicircuits.com/MCLStore/terms.jsp](http://www.minicircuits.com/MCLStore/terms.jsp)



# Low Noise Amplifier

# AMP-77+

## Typical Performance Data

FREQUENCY (MHz)	GAIN (dB)			DIRECTIVITY (dB)			VSWR IN (:1) 15V	VSWR OUT (:1) 15V	NOISE FIGURE (dB) 15V	Pout at 1dB Comp. (dBm) 15V
	12V	15V	16V	12V	15V	16V				
5.0	16.26	16.25	16.23	5.00	5.00	5.10	1.49	1.57		18.30
11.3	16.55	16.58	16.55	4.30	4.30	4.30	1.25	1.25	3.30	18.96
33.4	16.75	16.79	16.76	3.80	3.80	3.80	1.13	1.09	3.27	19.66
98.8	16.74	16.77	16.76	3.50	3.50	3.50	1.11	1.16	3.30	19.68
195.4	16.55	16.59	16.57	2.90	3.00	3.00	1.13	1.35	3.24	19.62
246.2	16.43	16.47	16.46	2.50	2.70	2.70	1.15	1.41	3.24	19.49
309.6	16.27	16.32	16.28	2.20	2.30	2.40	1.18	1.47	3.27	19.24
373.1	16.13	16.19	16.14	1.80	1.90	2.00	1.21	1.45	3.25	19.08
436.5	16.04	16.08	16.04	1.40	1.60	1.70	1.23	1.44	3.26	19.11
500.0	15.92	15.98	15.93	1.10	1.30	1.40	1.24	1.36	3.28	19.25

REV. X1  
AMP-77+  
060912  
Page 1 of 1



IF/RF MICROWAVE COMPONENTS • ISO 9001 ISO 14001 AS 9100 CERTIFIED RoHS compliant  
P.O. Box 350166, Brooklyn, New York 11235-0003 (718) 934-4500 Fax (718) 332-4661



The Design Engineers Search Engine finds the model you need, Instantly • For detailed performance specs & shopping online see



## Typical Performance Curves

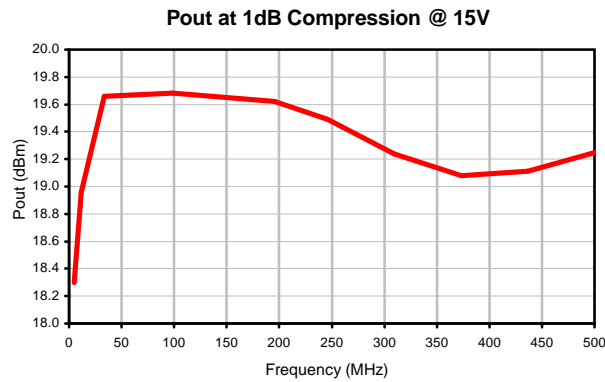
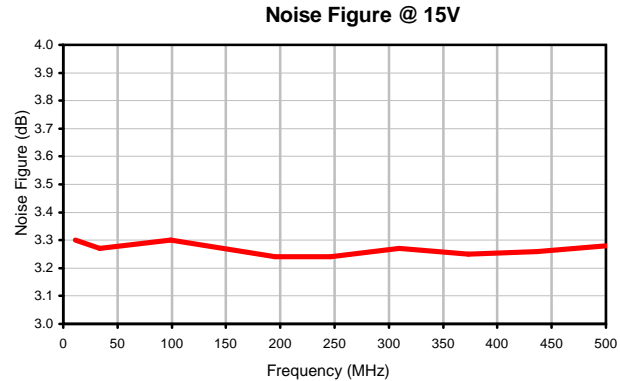
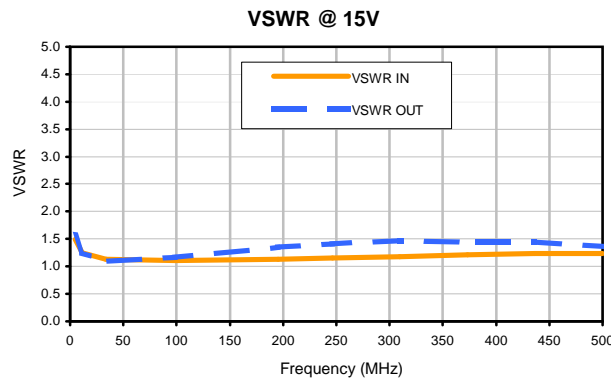
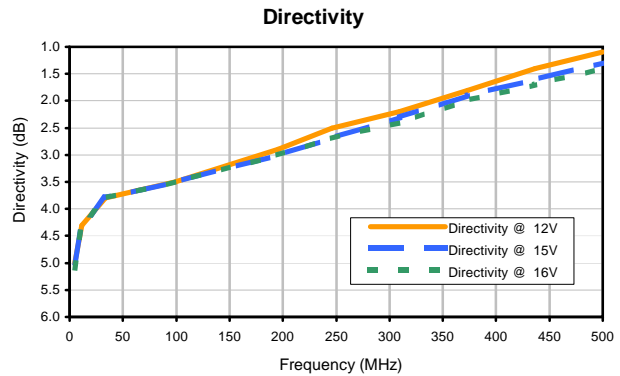
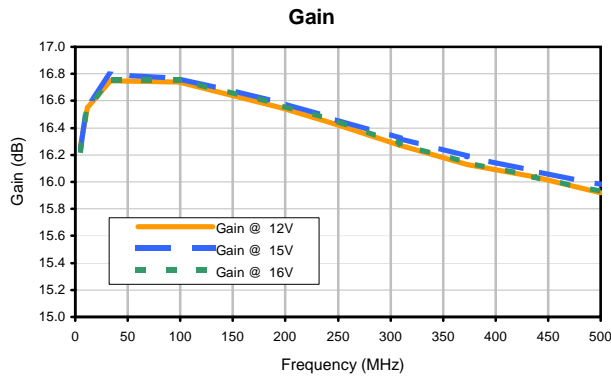

## Outline Dimensions

PP120  
PP230

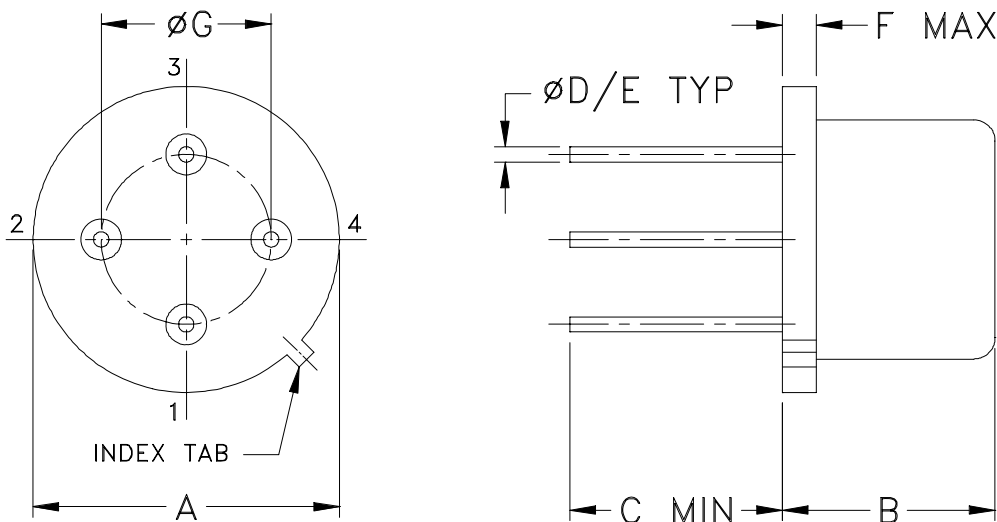

CASE#	A	B	C	D	E	F	G	WT, GRAM
PP120	.50 (12.70)	.21 (5.33)	.15 (3.81)	.016 (.41)	.020 (.51)	.04 (1.02)	.300 (7.62)	1.5
PP230		.250 (6.35)	.24 (6.10)					1.8

Dimensions are in inches (mm). Tolerances: 2 Pl.  $\pm .03$ ; 3 Pl.  $\pm .015$

### Notes:

- Header material: C.R.S. or kovar.  
Pin material: # 52 alloy or kovar.  
Cover material: Nickel.
- Pin finish: Gold plate 25  $\mu$ inches (.64 microns) min.
- For pin designations see specifications data sheet.
- Pin numbers do not appear on unit, for reference only.

**Mini-Circuits**<sup>®</sup>

INTERNET <http://www.minicircuits.com>

P.O. Box 350166, Brooklyn, New York 11235-0003 (718) 934-4500 Fax (718) 332-4661

Distribution Centers NORTH AMERICA 800-654-7949 • 417-335-5935 • Fax 417-335-5945 • EUROPE 44-1252-832600 • Fax 44-1252-837010

Mini-Circuits ISO 9001 & ISO 14001 Certified

All Mini-Circuits products are manufactured under exacting quality assurance and control standards, and are capable of meeting published specifications after being subjected to any or all of the following physical and environmental test.

Specification	Test/Inspection Condition	Reference/Spec
Operating Temperature	-54° to 85°C Ambient Environment	Individual Model Data Sheet
Storage Temperature	-55° to 100° C Ambient Environment	Individual Model Data Sheet
Thermal Shock	-55° to 100°C, 10 cycles	MIL-STD-202, Method 107, Condition A, except +100°C & 10 cycles
Constant Acceleration	5000g, Y1 axis	MIL-STD-883, Method 2001, Condition A, except Y1 axis only
Solderability	10X Magnification	J-STD-002, 95% Coverage
Resistance to Solder Heat	260°C for 10 seconds	MIL-STD-202, Method 210, Condition B
Marking Resistance to Solvents	Isopropyl alcohol + mineral spirits at 25°C; terpene defluxer at 25°C; distilled water + proylene glycol monomethyl ether + monoethanolamine at 63°C to 70°C	MIL-STD-202, Method 215
Gross Leak	125°C Bubble Test	MIL-STD-202, Method 112, Condition D