



THIN FILM SURFACE MOUNT

Low Pass Filter

ALF-6000+

Mini-Circuits

50Ω DC to 6GHz

KEY FEATURES

- Low Passband Insertion Loss of 0.7dB Typ.
- High Rejection of 38dB Typ.
- Good Return Loss of 16dB Typ.
- Small Size, 5.59 x 8.13 x 2.03 mm

APPLICATIONS

- Harmonic Rejection
- VHF/UHF Transmitters/Receivers.
- Test and Measurement Equipment.

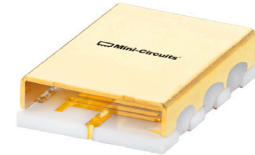

Generic photo used for illustration purposes only

PRODUCT OVERVIEW

Mini-Circuits' Surface Mount Thin-Film filters offer low insertion loss and high rejection realized via Thin-Film on Alumina substrate, using a sputtering process that can guarantee an enhanced Q and repeatable performance. Low pass, high pass, and bandpass surface mount thin-film designs can be realized with this technology up to 40GHz in a small form factor helping customers achieve their SWaP objectives. Using our high quality thin-film manufacturing process we can guarantee repeatability on large batches of filters.

FUNCTIONAL DIAGRAM

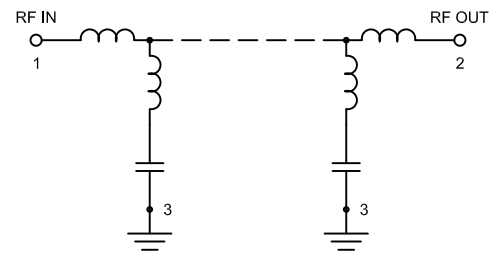

ELECTRICAL SPECIFICATIONS^{1,2} AT +25°C

| Parameter | | F# | Frequency (GHz) | Min. | Typ. | Max. | Units |
|-----------|----------------------------|-------|-----------------|------|------|------|-------|
| Pass Band | Insertion Loss | DC-F1 | DC - 6 | — | 0.7 | 1.2 | dB |
| | Freq. Cut-Off ³ | Fc | 6.93 | — | 3.0 | — | dB |
| | Return Loss | DC-F1 | DC - 6 | — | 16 | — | dB |
| Stop Band | Rejection | F2-F3 | 8.2 - 9.4 | 25 | 37 | — | dB |
| | | F3-F4 | 9.4 - 13 | 32 | 37 | — | |
| | | F4-F5 | 13 - 14 | — | 38 | — | |
| | | F5-F6 | 14 - 15.5 | — | 15 | — | |

1. Tested in Evaluation Board P/N TB-ALF-6000+ with feedline losses removed by normalization of S12 and S21 traces to measurement of TB thru-line.

2. This filter is bi-directional RF1 and RF2 ports may be interchanged, see S-Parameters for actual performance.

3. Typical variation ±3%

ABSOLUTE MAXIMUM RATINGS⁴

| Parameter | Ratings |
|--------------------------|-------------------|
| Operating Temperature | -55 °C to +125 °C |
| Storage Temperature | -55 °C to +125 °C |
| Input Power ⁵ | 15 Max. at 25°C |

4. Permanent damage may occur if any of these limits are exceeded.

5. Power rating applies only to signals within the passband.

TYPICAL FREQUENCY RESPONSE

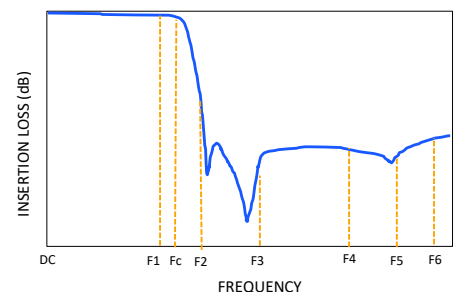



THIN FILM SURFACE MOUNT

Low Pass Filter

ALF-6000+

Mini-Circuits

50Ω DC to 6GHz

TYPICAL PERFORMANCE GRAPHS AT +25°C

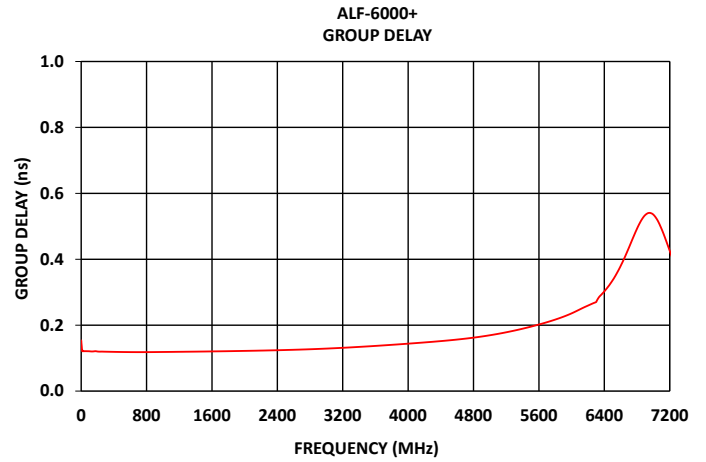
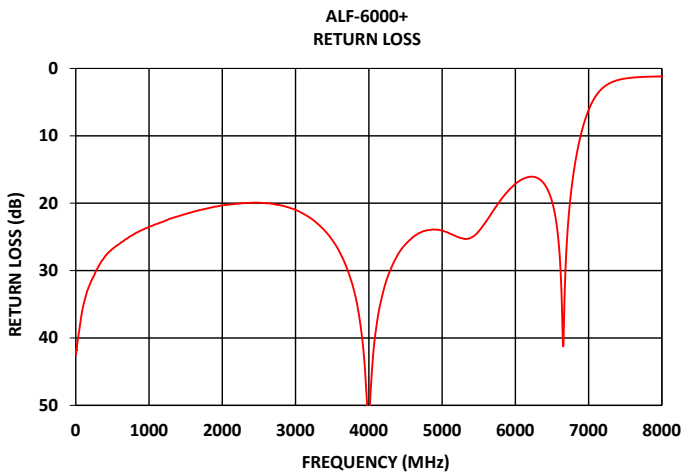
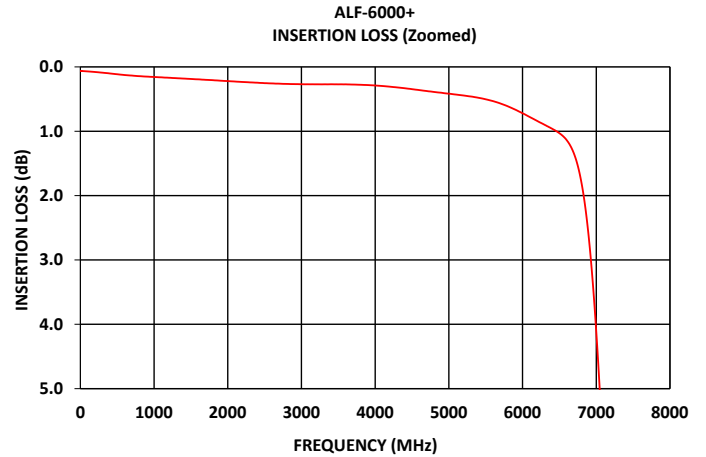
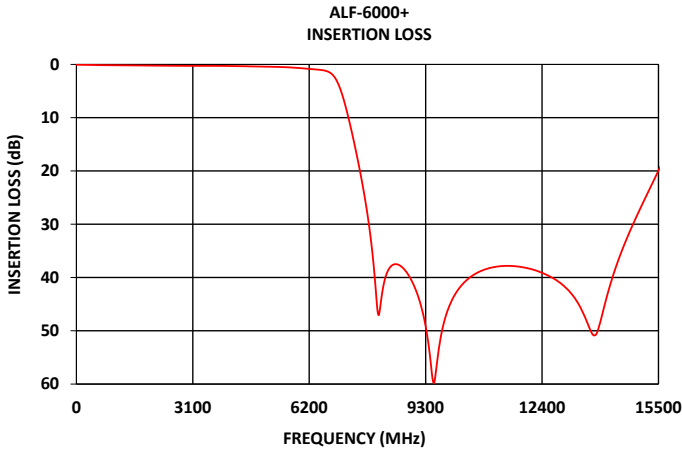



FUNCTIONAL DIAGRAM

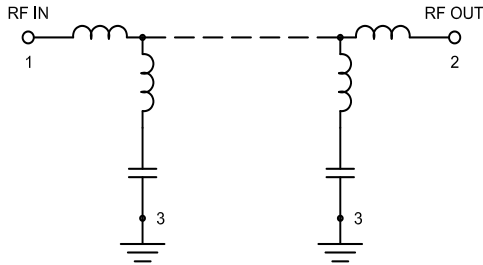
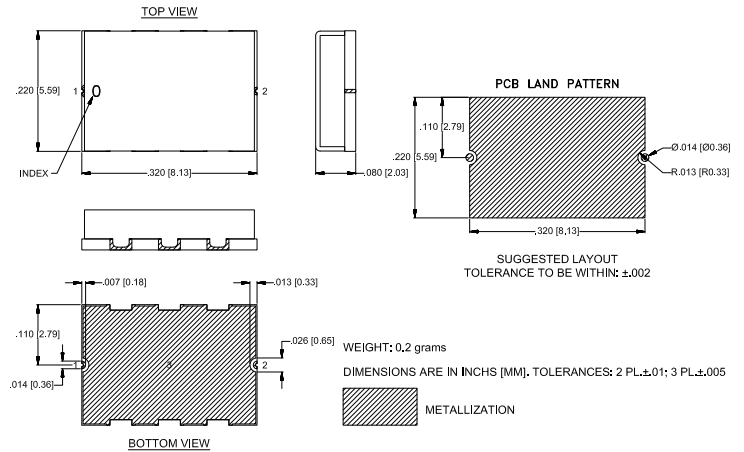

Figure 1. ALF-6000+ Functional Diagram

PAD DESCRIPTION

| Function | Pad Number | Description |
|------------------|------------|--|
| RF1 ² | 1 | Connects to RF Input Port |
| RF2 ² | 2 | Connects to RF Output Port |
| GROUND | 3 | Connects to Ground on PCB, (See drawing PL-764) |
| NC | — | No connection, not used internally. See drawing PL-764 for connection to PCB |

CASE STYLE DRAWING



SUGGESTED PCB LAYOUT (PL-764)

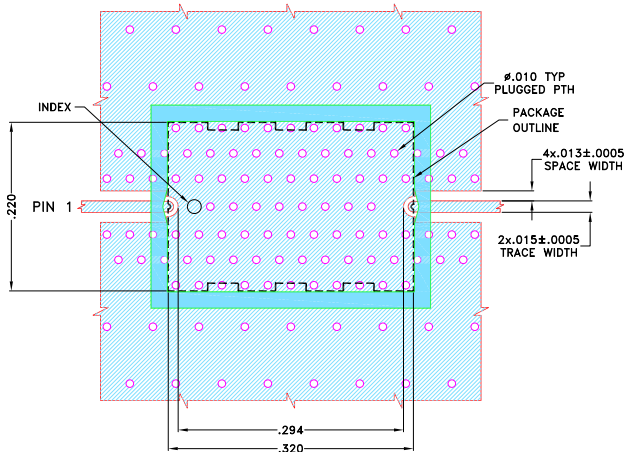

NOTES:

1. COPLANAR WAVEGUIDE PARAMETERS ARE SHOWN FOR ROGERS (RO4350B Lo Pro) WITH DIELECTRIC THICKNESS .0073±.0007. COPPER: 1/2 Oz. EACH SIDE. FOR OTHER MATERIALS TRACE WIDTH AND GAP MAY NEED TO BE MODIFIED.
 2. BOTTOM SIDE OF THE PCB IS CONTINUOUS GROUND PLANE.
- DENOTES PCB COPPER PATTERN WITH SMOBC (SOLDER MASK OVER BARE COPPER)
 DENOTES PCB COPPER PATTERN FREE OF SOLDERMASK

Figure 2. Suggested PCB Layout PL-764

PRODUCT MARKING*: ALF-6000

*Marking may contain other features or characters for internal lot control.



RECOMMENDED PCB LAYOUT PATTERN FOR FILTER

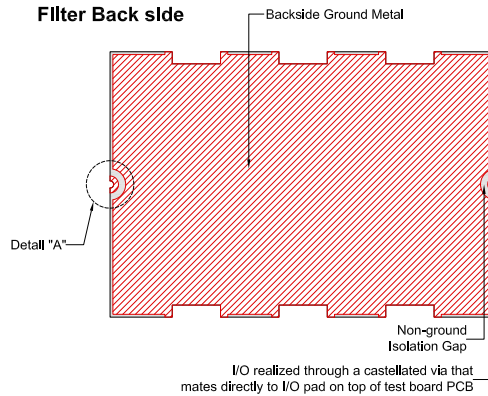

Filter RF I/O Detail (Filter Back Side)

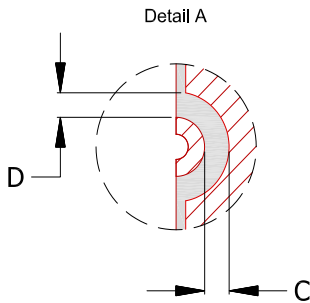

PCB Pattern Recommendations

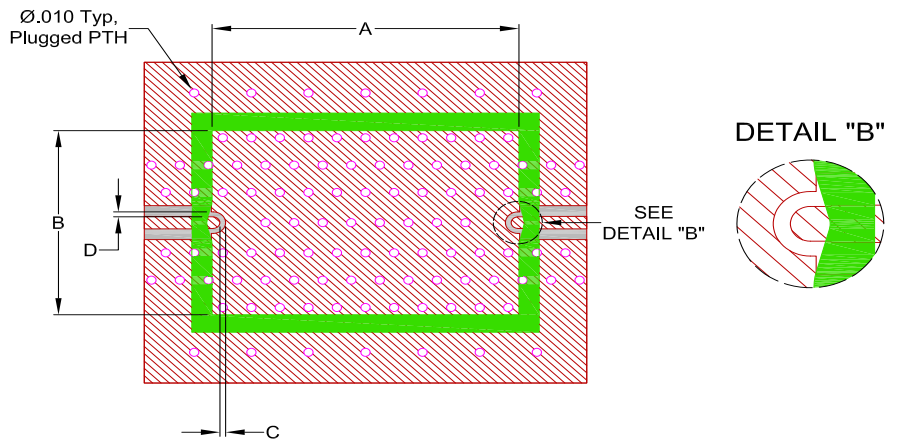

- 1) Customer PCB's ground pattern length (dimension A) can be similar to filter length.
- 2) Customer PCB's ground pattern width (dimension B) can be similar filter width.
- 3) Dimensions C and D on Filter RF I/O detail and Customer PCB pattern can be closely match. The dimensions of C and D on the Customer PCB pattern can be slightly larger to account for component alignment tolerance (ground metal can be pulled back from RF I/O trace).
- 4) Recommend to use Solder mask at Customer PCB at outer area of filter pattern/ footprint with a clearance of about 1.25mil at each side. (Tighter registration tolerance required for solder mask)
- 5) Recommended to use Solder mask at I/O of Customer PCB as per above diagram (refer detail B).



COMMENTS ON COMPONENT HANDLING AND SOLDER ATTACH

- 1) Avoid using soldering iron directly to the ceramic filter. This would lead to development of crack in the component due to thermal shock.
- 2) Vacuum pick-up tool or plastic tweezers are recommended for handling the components. Extra care should be taken not to scratch the filter or metal area.
- 3) Use 2-3 mil thickness stencil plate and screen print the solder. Refer below picture for recommended stencil pattern to get the best solder attachment.

Stencil opening drawing

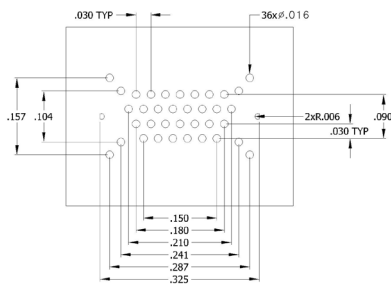

Solder location after screen print

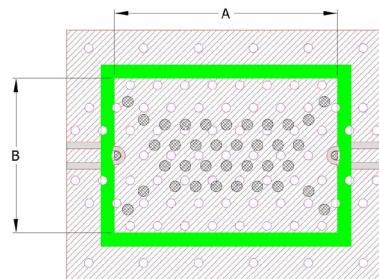

- 4) Plugged ground vias in the PWB will improve attachment consistency.
- 5) Recommended to have a similar or closer test board material and thickness (refer Mini-Circuits evaluation board for details) to minimize the CTE over the temperature range.



THIN FILM SURFACE MOUNT

Low Pass Filter

ALF-6000+

Mini-Circuits

50Ω DC to 6GHz

ADDITIONAL DETAILED INFORMATION IS AVAILABLE ON OUR DASH BOARD.

[CLICK HERE](#)

| | |
|---------------------------------|---|
| Performance Data and Graphs | Data |
| | Graphs |
| | S-Parameter (S2P Files) Data Set (.zip file) De-embedded to device pads |
| Case Style | UC2731 Lead Finish: Gold over Nickel Plate. |
| RoHS Status | Compliant |
| Tape and Reel | TR-F003 |
| Suggested Layout for PCB Design | PL-764 |
| Evaluation Board | TB-ALF-6000+ |
| | Gerber File |
| Environmental Rating | ENV120 |

NOTES

- A. Performance and quality attributes and conditions not expressly stated in this specification document are intended to be excluded and do not form a part of this specification document.
- B. Electrical specifications and performance data contained in this specification document are based on Mini-Circuits' applicable established test performance criteria and measurement instructions.
- C. The parts covered by this specification document are subject to Mini-Circuits' standard limited warranty and terms and conditions (collectively, "Standard Terms"); Purchasers of this part are entitled to the rights and benefits contained therein. For a full statement of the standard terms and the exclusive rights and remedies thereunder, please visit Mini-Circuits' website at www.minicircuits.com/terms/viewterm.html



Thin-Film Lowpass Filter

ALF-6000+

Typical Performance Data

| FREQ. | Insertion Loss | Input Return Loss | Output Return Loss | FREQ. | Group Delay |
|-------|----------------|-------------------|--------------------|-------|-------------|
| (MHz) | (dB) | (dB) | (dB) | (MHz) | (ns) |
| 1 | 0.06 | 42.40 | 41.99 | 10 | 0.13 |
| 10 | 0.06 | 41.77 | 41.76 | 20 | 0.12 |
| 20 | 0.06 | 40.86 | 41.30 | 25 | 0.12 |
| 50 | 0.07 | 38.68 | 38.92 | 50 | 0.12 |
| 75 | 0.07 | 36.79 | 37.16 | 75 | 0.12 |
| 100 | 0.07 | 35.33 | 35.74 | 100 | 0.12 |
| 125 | 0.07 | 34.25 | 34.56 | 125 | 0.12 |
| 150 | 0.07 | 33.25 | 33.56 | 150 | 0.12 |
| 175 | 0.08 | 32.50 | 32.71 | 175 | 0.12 |
| 200 | 0.08 | 31.83 | 31.97 | 200 | 0.12 |
| 300 | 0.09 | 29.59 | 29.76 | 225 | 0.12 |
| 400 | 0.10 | 27.88 | 28.21 | 250 | 0.12 |
| 500 | 0.11 | 26.78 | 27.13 | 300 | 0.12 |
| 600 | 0.13 | 26.00 | 26.35 | 400 | 0.12 |
| 700 | 0.13 | 25.25 | 25.57 | 500 | 0.12 |
| 800 | 0.14 | 24.55 | 24.88 | 600 | 0.12 |
| 900 | 0.15 | 24.00 | 24.40 | 700 | 0.12 |
| 1000 | 0.16 | 23.52 | 23.89 | 800 | 0.12 |
| 1100 | 0.16 | 23.10 | 23.38 | 900 | 0.12 |
| 1200 | 0.17 | 22.69 | 22.92 | 1000 | 0.12 |
| 1500 | 0.19 | 21.60 | 21.66 | 1100 | 0.12 |
| 2000 | 0.22 | 20.34 | 20.23 | 1200 | 0.12 |
| 2500 | 0.25 | 19.92 | 19.90 | 1300 | 0.12 |
| 3000 | 0.27 | 20.99 | 21.33 | 1400 | 0.12 |
| 3500 | 0.27 | 25.45 | 26.50 | 1500 | 0.12 |
| 4000 | 0.29 | 51.94 | 34.89 | 1600 | 0.12 |
| 5000 | 0.42 | 24.05 | 22.59 | 1700 | 0.12 |
| 6000 | 0.72 | 17.13 | 17.11 | 1800 | 0.12 |
| 6930 | 3.03 | 8.39 | 7.54 | 1900 | 0.12 |
| 7000 | 4.11 | 6.16 | 5.60 | 2000 | 0.12 |
| 7100 | 6.18 | 4.06 | 3.72 | 2100 | 0.12 |
| 7300 | 11.67 | 2.12 | 1.97 | 2200 | 0.12 |
| 7500 | 18.20 | 1.50 | 1.41 | 2300 | 0.12 |
| 7700 | 25.88 | 1.28 | 1.21 | 2400 | 0.12 |
| 7900 | 36.60 | 1.21 | 1.12 | 2500 | 0.12 |
| 8000 | 44.85 | 1.19 | 1.09 | 2600 | 0.13 |
| 8100 | 45.03 | 1.18 | 1.07 | 2700 | 0.13 |
| 8200 | 40.75 | 1.17 | 1.06 | 2800 | 0.13 |
| 8300 | 38.66 | 1.17 | 1.04 | 2900 | 0.13 |
| 8500 | 37.49 | 1.16 | 1.02 | 3000 | 0.13 |
| 8700 | 38.23 | 1.16 | 0.99 | 3100 | 0.13 |
| 9000 | 41.69 | 1.13 | 0.96 | 3200 | 0.13 |
| 9400 | 53.84 | 1.07 | 0.92 | 3300 | 0.13 |
| 9500 | 59.60 | 1.05 | 0.91 | 3400 | 0.13 |
| 10000 | 44.24 | 0.93 | 0.87 | 3500 | 0.14 |
| 10100 | 42.97 | 0.91 | 0.86 | 3600 | 0.14 |
| 10300 | 41.13 | 0.86 | 0.86 | 3700 | 0.14 |
| 10500 | 39.87 | 0.83 | 0.85 | 3800 | 0.14 |
| 10900 | 38.44 | 0.81 | 0.87 | 3900 | 0.14 |
| 11000 | 38.23 | 0.81 | 0.87 | 4000 | 0.14 |
| 11300 | 37.86 | 0.83 | 0.90 | 4200 | 0.15 |
| 11500 | 37.82 | 0.87 | 0.93 | 4400 | 0.15 |
| 12000 | 38.24 | 0.97 | 1.00 | 4600 | 0.16 |
| 12300 | 38.84 | 1.04 | 1.04 | 4800 | 0.16 |
| 12500 | 39.43 | 1.08 | 1.06 | 5000 | 0.17 |
| 12700 | 40.15 | 1.12 | 1.09 | 5200 | 0.18 |
| 13000 | 41.71 | 1.16 | 1.11 | 5400 | 0.19 |
| 13500 | 46.76 | 1.20 | 1.16 | 5600 | 0.20 |
| 14000 | 46.99 | 1.20 | 1.20 | 5800 | 0.22 |
| 15500 | 19.93 | 1.12 | 1.87 | 6000 | 0.24 |

Typical Performance Curves

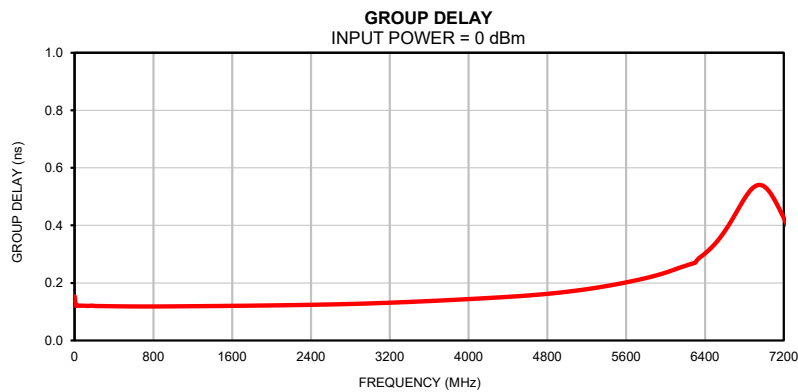
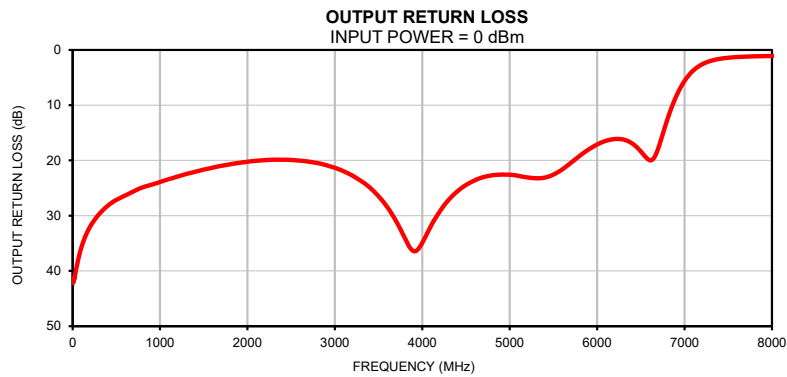
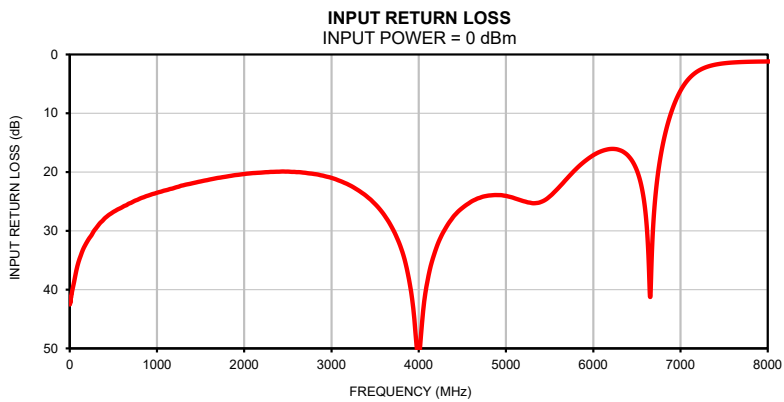
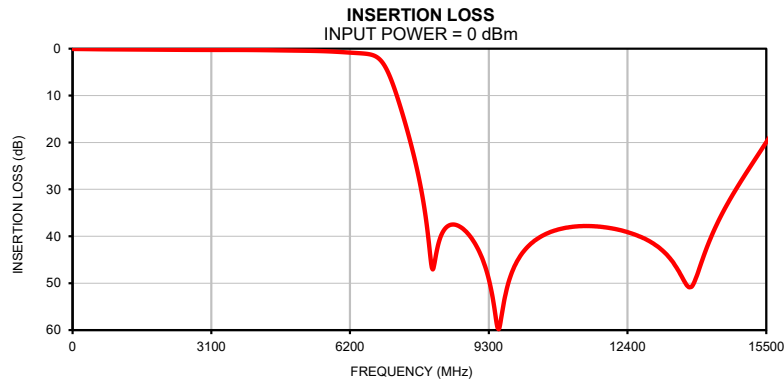

Outline Dimensions

UC2731

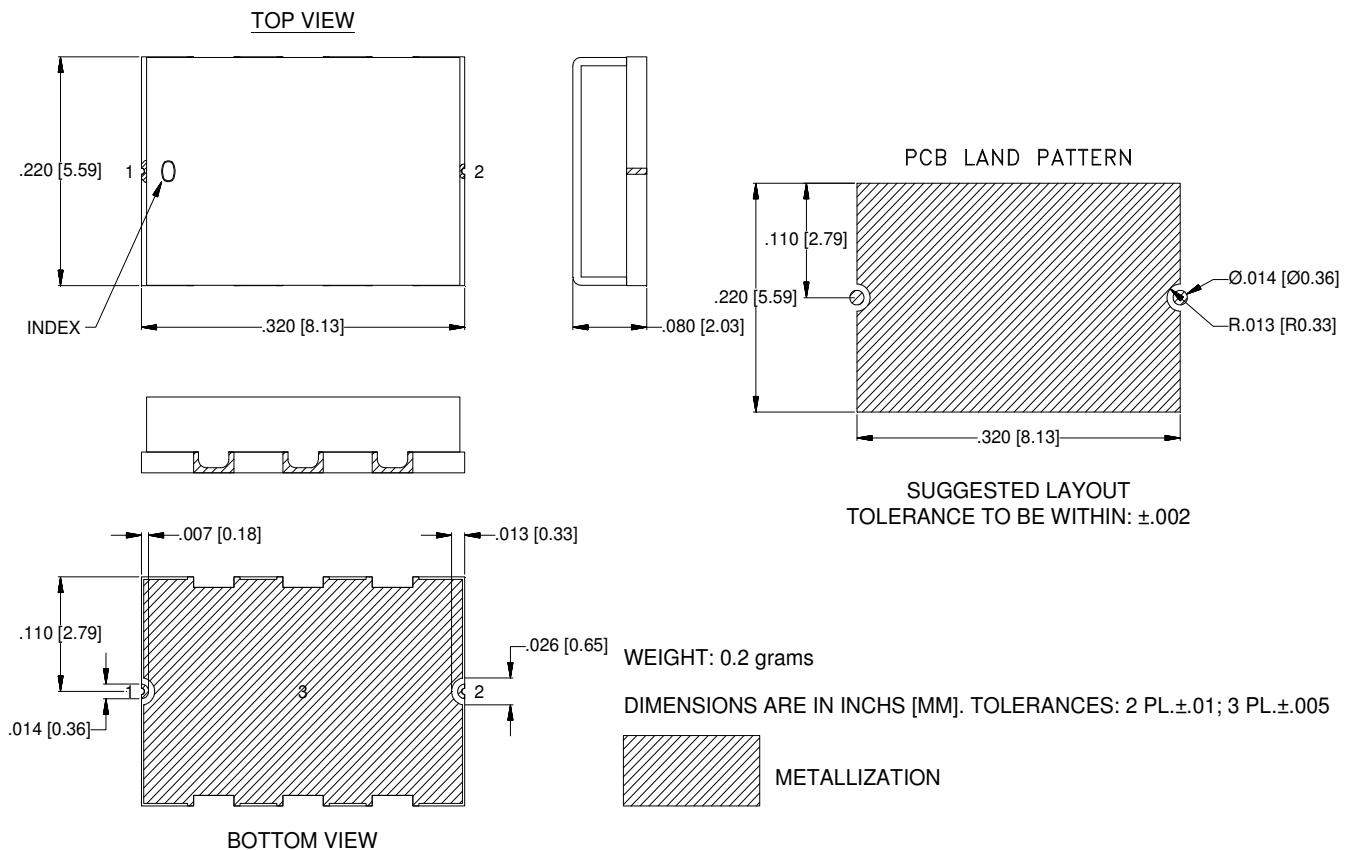

Notes:

1. Case material: Gold over Nickel over Annealed Stainless Steel.
2. Base: Ceramic
3. Termination finish: **as shown below or indicated on Data Sheet.**
For RoHS Case Styles: Gold over Nickel plate. All models, (+) suffix.



P.O. Box 350166, Brooklyn, New York 11235-0003 (718) 934-4500 Fax (718) 332-4661 For detailed performance specs & shopping online see Mini-Circuits web site



The Design Engineers Search Engine Provides ACTUAL Data Instantly From MINI-CIRCUITS At: www.minicircuits.com

RF/IF MICROWAVE COMPONENTS

THIRD ANGLE PROJECTION

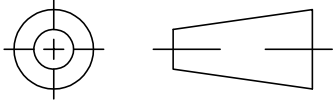

REVISIONS

| REV | ECN No. | DESCRIPTION | DATE | DR | AUTH |
|-----|------------|-------------|--------|----|------|
| OR | NPO-003903 | NEW RELEASE | OCT 23 | LK | VC |
| | | | | | |
| | | | | | |

**SUGGESTED MOUNTING CONFIGURATION
FOR UC2731 CASE STYLE**

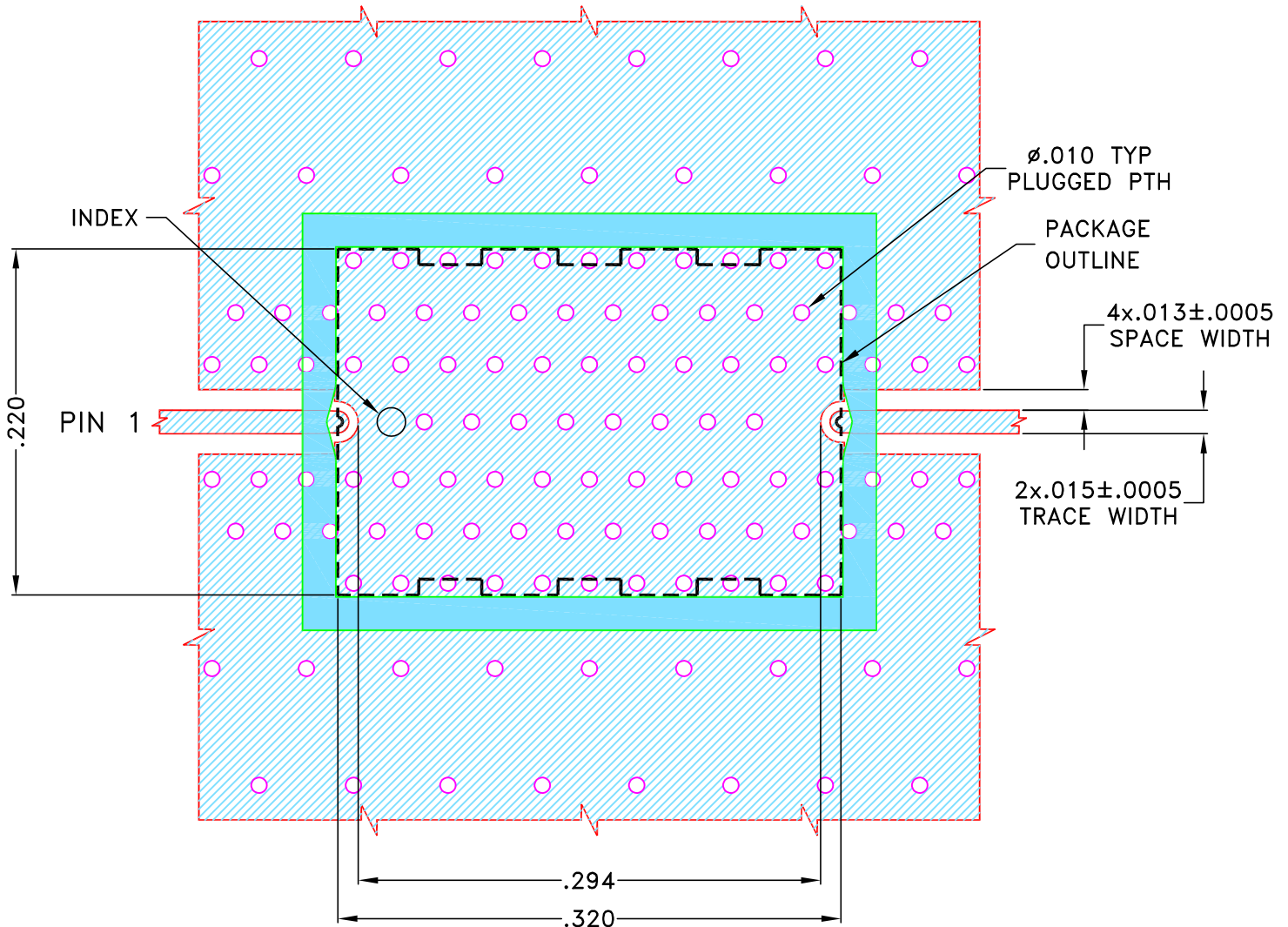

NOTES:

1. COPLANAR WAVEGUIDE PARAMETERS ARE SHOWN FOR ROGERS (R04350B Lo Pro) WITH DIELECTRIC THICKNESS $.0073 \pm .0007$. COPPER: 1/2 Oz. EACH SIDE.
FOR OTHER MATERIALS TRACE WIDTH AND GAP MAY NEED TO BE MODIFIED.
2. BOTTOM SIDE OF THE PCB IS CONTINUOUS GROUND PLANE.

- DENOTES PCB COPPER PATTERN WITH SMOBC (SOLDER MASK OVER BARE COPPER)
- DENOTES PCB COPPER PATTERN FREE OF SOLDERMASK

| UNLESS OTHERWISE SPECIFIED | INITIALS | DATE |
|----------------------------|-------------|-----------|
| DIMENSIONS ARE IN INCHES | DRAWN LK | 09 OCT 23 |
| TOLERANCES ON: | CHECKED MD | 09 OCT 23 |
| 2 PL DECIMALS ± | APPROVED RR | 13 OCT 23 |
| 3 PL DECIMALS ± .005 | | |
| ANGLES ± | | |
| FRACTIONS ± | | |

Mini-Circuits® 13 Neptune Avenue
Brooklyn NY 11235

PL DWG, UC2731 C.S, 50 OHM, ALF

Mini-Circuits®
THIS DOCUMENT AND ITS CONTENTS ARE THE PROPERTY OF MINI-CIRCUITS. EXCEPT FOR USE EXPRESSLY GRANTED, IN WRITING, TO ITS VENDORS, VENDEE AND THE UNITED STATES GOVERNMENT, MINI-CIRCUITS RESERVES ALL PROPRIETARY DESIGN, USE, MANUFACTURING AND REPRODUCTION RIGHTS THERETO. THESE CONTENTS SHALL NOT BE USED, DUPLICATED OR DISCLOSED TO ANY OUTSIDE PARTY, IN WHOLE OR IN PART, WITHOUT WRITTEN PERMISSION OF MINI-CIRCUITS.

| SIZE | CODE IDENT | DRAWING NO: | REV: |
|-------|------------|-------------|---------------------|
| A | 15542 | 98-PL-764 | OR |
| FILE: | 98-PL-764 | SCALE: | 9.1:1 SHEET: 1 OF 1 |

Evaluation Board and Circuit

TB-ALF-6000+

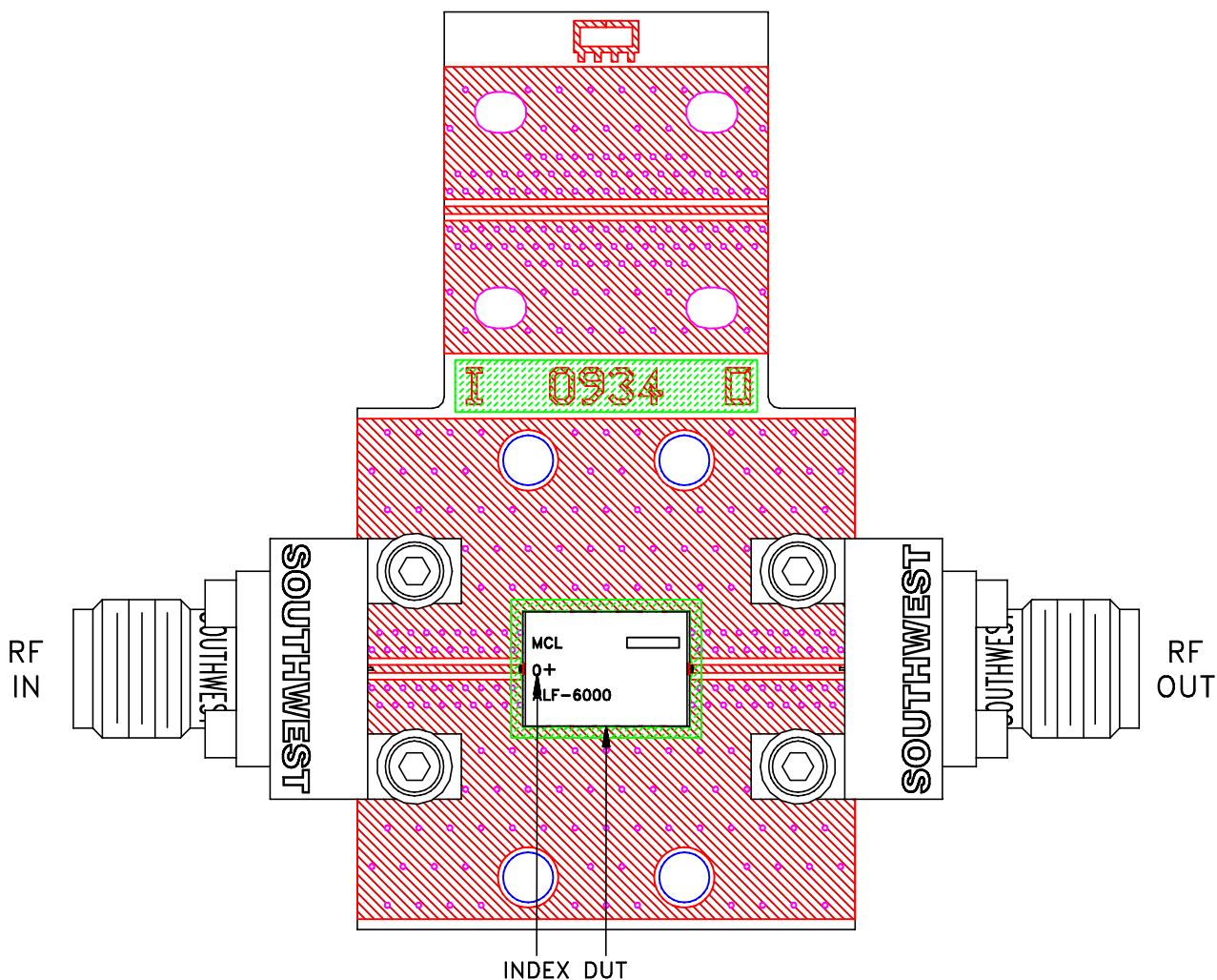

Schematic diagram

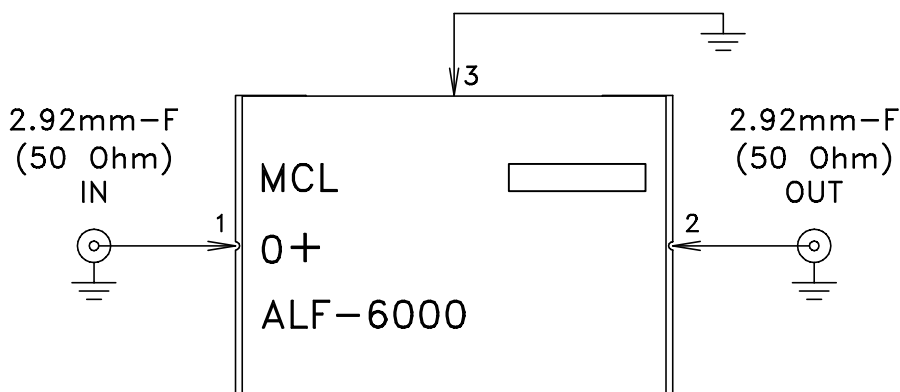

Notes:

1. PCB Material: ROGERS (R04350B Lo Pro) OR Equivalent, Dielectric Constant=3.48±.05
Dielectric Thickness: .0073±.0007 inch
2. 50 Ohm 2.92mm Female Connectors.

 **Mini-Circuits®**

All Mini-Circuits products are manufactured under exacting quality assurance and control standards, and are capable of meeting published specifications after being subjected to any or all of the following physical and environmental test.

| Specification | Test/Inspection Condition | Reference/Spec |
|-----------------------|---------------------------------------|---|
| Operating Temperature | -55° to 125° C Ambient Environment | Individual Model Data Sheet |
| Storage Temperature | -55° to 125° C Ambient Environment | Individual Model Data Sheet |
| Solderability | 10X Magnification | J-STD-002, Para 4.2.5, Test S, 95% Coverage |
| Thermal Shock | -55° to 125°C, 100 cycles | MIL-STD-202, Method 107, Condition A-3, Except +125°C |