



## THIN FILM SURFACE MOUNT

# Low Pass Filter

# ALF-5000+

50Ω DC to 5 GHz

### KEY FEATURES

- Low Passband Insertion Loss of 1 dB Typ.
- High Rejection of 40 dB Typ.
- Good Return Loss of 15 dB Typ.
- Small Size, 5.59 x 8.13 x 2.03 mm

### APPLICATIONS

- Military Applications
- Telecommunication & Broadband Wireless System
- Test and Measurement Equipment
- 5G sub 6 GHz

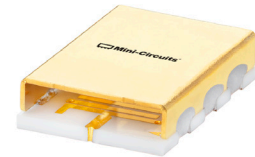

Generic photo used for illustration purposes only

### PRODUCT OVERVIEW

Mini-Circuits' Surface Mount Thin-Film filters offer low insertion loss and high rejection realized via Thin-Film on Alumina substrate, using a sputtering process that can guarantee an enhanced Q and repeatable performance. Low pass, high pass, and bandpass surface mount thin-film designs can be realized with this technology up to 40 GHz in a small form factor helping customers achieve their SWaP objectives. Using our high quality thin-film manufacturing process we can guarantee repeatability on large batches of filters.

### FUNCTIONAL DIAGRAM

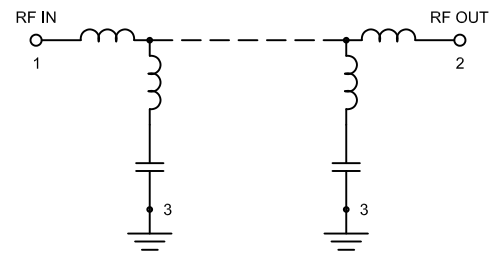

### ELECTRICAL SPECIFICATIONS<sup>1,2</sup> AT +25°C

Parameter		F#	Frequency (GHz)	Min.	Typ.	Max.	Units
Pass Band	Insertion Loss	DC-F1	DC - 5	—	1	1.7	dB
	Freq. Cut-Off <sup>3</sup>	Fc	5.77	—	3	—	dB
	Return Loss	DC-F1	DC - 5	—	15	—	dB
Stop Band	Rejection	F2-F3	6.7 - 7.5	20	40	—	dB
		F3-F4	7.5 - 12	33	40	—	
		F4-F5	12 - 17	—	20	—	

1. Tested in Evaluation Board P/N TB-ALF-5000+ with feedline losses removed by normalization of S12 and S21 traces to measurement of TB thru-line.

2. This filter is bi-directional RF1 and RF2 ports may be interchanged, see S-Parameters for actual performance.

3. Typical variation ±3%

### ABSOLUTE MAXIMUM RATINGS<sup>4</sup>

Parameter	Ratings
Operating Temperature	-55 °C to +125 °C
Storage Temperature	-55 °C to +125 °C
Input Power <sup>5</sup>	8W Max. at +25°C

4. Permanent damage may occur if any of these limits are exceeded.

5. Power rating applies only to signals within the passband

### TYPICAL FREQUENCY RESPONSE AT +25°C

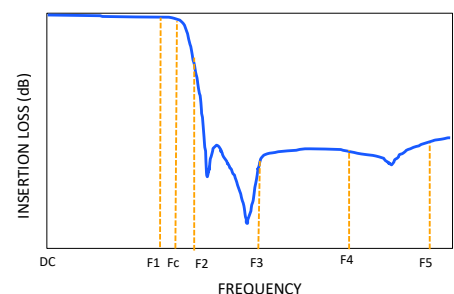



THIN FILM SURFACE MOUNT

# Low Pass Filter

## ALF-5000+

Mini-Circuits

50Ω DC to 5 GHz

### TYPICAL PERFORMANCE GRAPHS AT +25°C

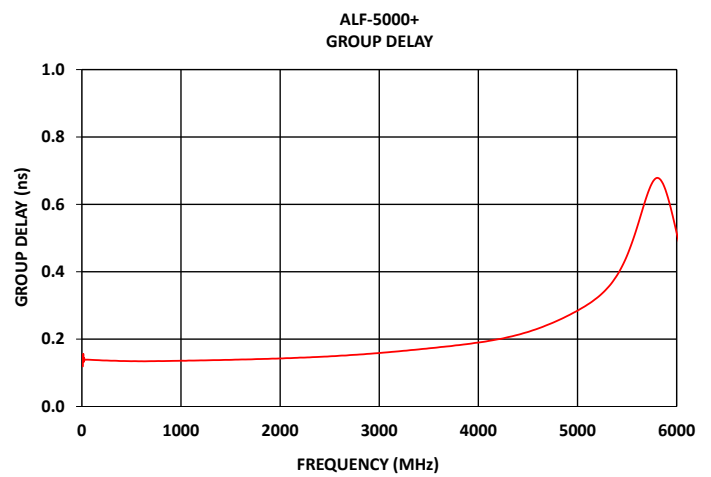
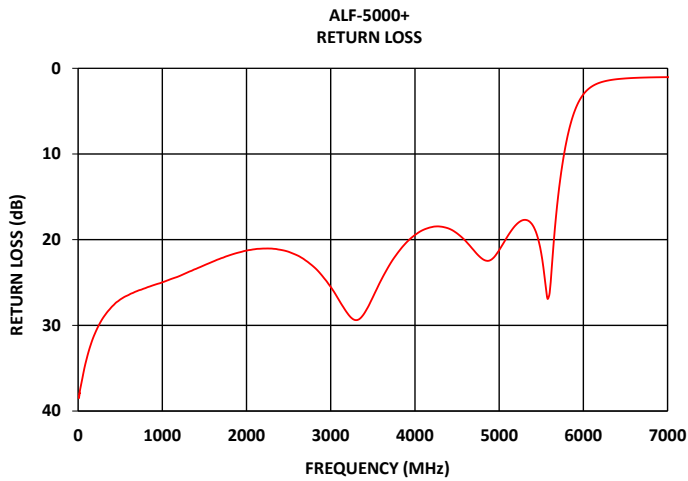
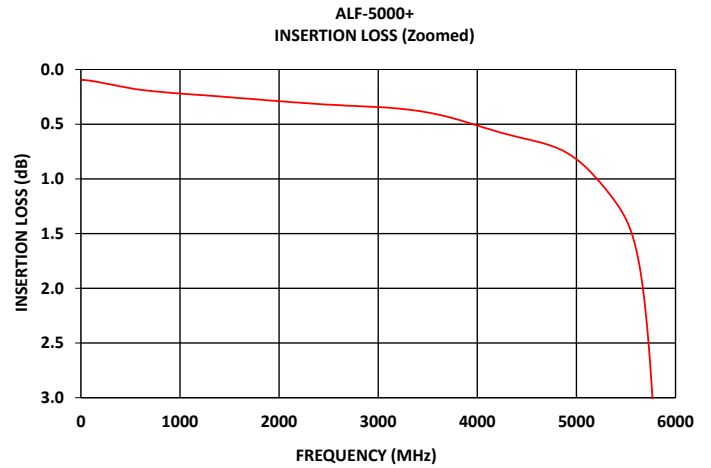
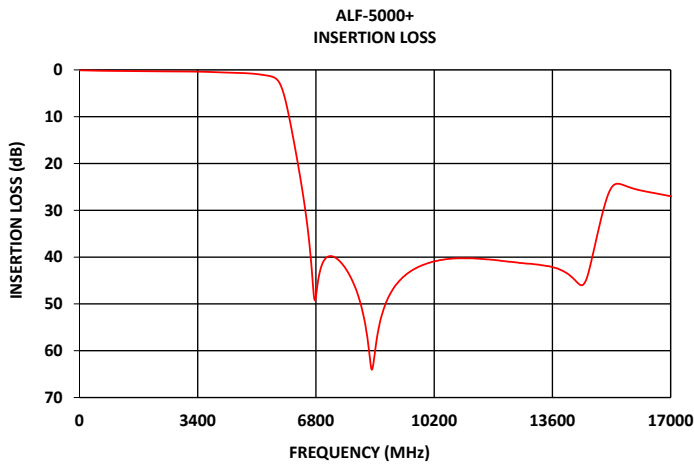



### FUNCTIONAL DIAGRAM

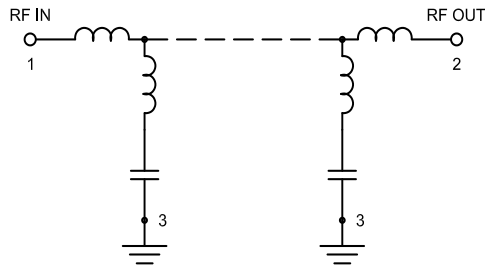
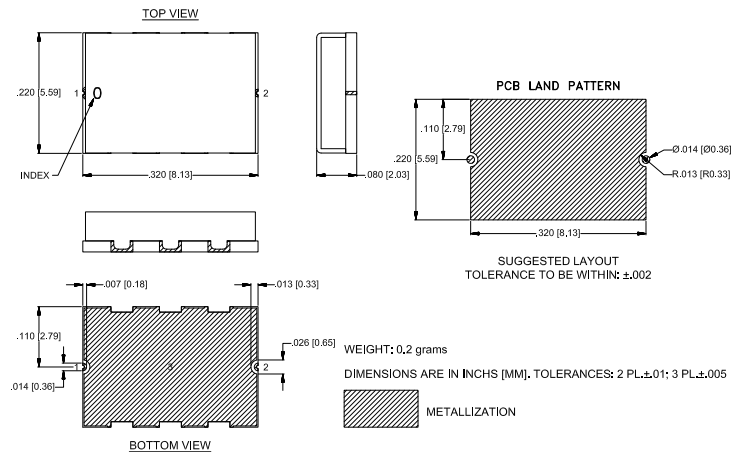

Figure 1. ALF-5000+ Functional Diagram

### PAD DESCRIPTION

Function	Pad Number	Description
RF1 <sup>2</sup>	1	Connects to RF Input Port
RF2 <sup>2</sup>	2	Connects to RF Output Port
GROUND	3	Connects to Ground on PCB, (See drawing PL-652)
NC	—	No connection, not used internally. See drawing PL-652 for connection to PCB

### CASE STYLE DRAWING



### SUGGESTED PCB LAYOUT (PL-652)

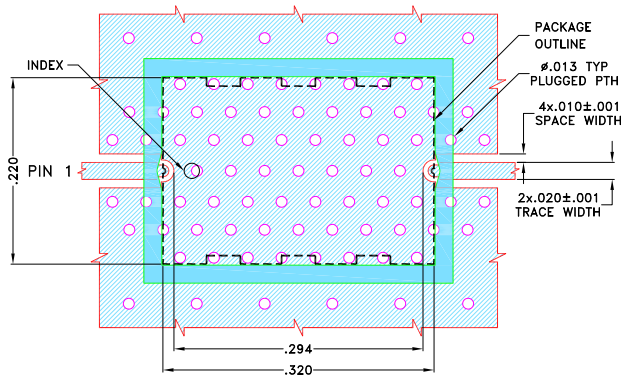

#### NOTES:

1. COPLANAR WAVEGUIDE PARAMETERS ARE SHOWN FOR ROGERS (R04350B) WITH DIELECTRIC THICKNESS .010±.0010. COPPER: 1/2 Oz. EACH SIDE. FOR OTHER MATERIALS TRACE WIDTH AND GAP MAY NEED TO BE MODIFIED.
  2. BOTTOM SIDE OF THE PCB IS CONTINUOUS GROUND PLANE.
- DENOTES PCB COPPER PATTERN WITH SMOBC (SOLDER MASK OVER BARE COPPER)  
 DENOTES PCB COPPER PATTERN FREE OF SOLDERMASK

Figure 2. Suggested PCB Layout PL-652

### PRODUCT MARKING\*: ALF-5000

\*Marking may contain other features or characters for internal lot control.



### RECOMMENDED PCB LAYOUT PATTERN FOR FILTER

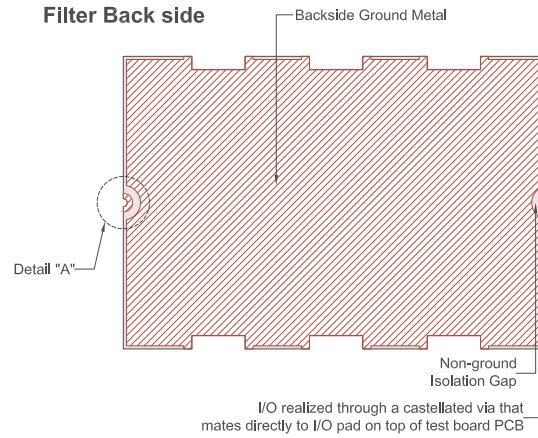

### PCB Pattern Recommendations

Filter RF I/O Detail (Filter Back Side)

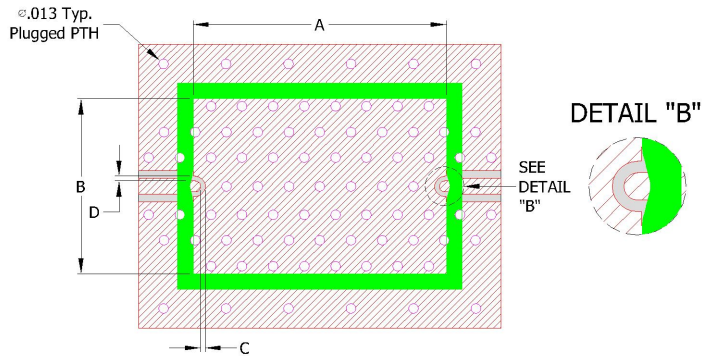
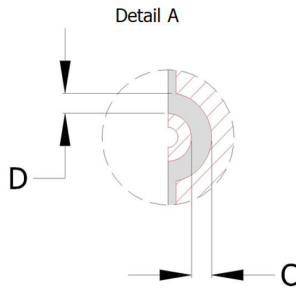

- 1) Customer PCB's ground pattern length (dimension A) can be similar to filter length.
- 2) Customer PCB's ground pattern width (dimension B) can be similar filter width.
- 3) Dimensions C and D on Filter RF I/O detail and Customer PCB pattern can be closely match. The dimensions of C and D on the Customer PCB pattern can be slightly larger to account for component alignment tolerance (ground metal can be pulled back from RF I/O trace).
- 4) Recommend to use Solder mask at Customer PCB at outer area of filter pattern/ footprint with a clearance of about 1.25mil at each side. (Tighter registration tolerance required for solder mask)
- 5) Recommended to use Solder mask at I/O of Customer PCB as per above diagram (refer detail B).



### COMMENTS ON COMPONENT HANDLING AND SOLDER ATTACH

- 1) Avoid using soldering iron directly to the ceramic filter. This would lead to development of crack in the component due to thermal shock.
- 2) Vacuum pick-up tool or plastic tweezers are recommended for handling the components. Extra care should be taken not to scratch the filter or metal area.
- 3) Use 2-3 mil thickness stencil plate and screen print the solder. Refer below picture for recommended stencil pattern to get the best solder attachment.

Stencil opening drawing

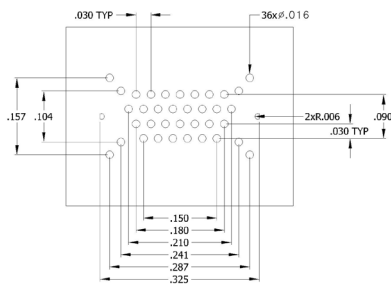

Solder location after screen print

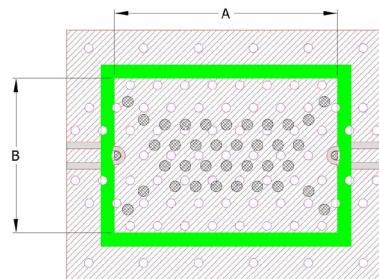

- 4) Plugged ground vias in the PWB will improve attachment consistency.
- 5) Recommended to have a similar or closer test board material and thickness (refer Mini-Circuits evaluation board for details) to minimize the CTE over the temperature range.



THIN FILM SURFACE MOUNT

# Low Pass Filter

## ALF-5000+

Mini-Circuits

50Ω DC to 5 GHz

ADDITIONAL DETAILED INFORMATION IS AVAILABLE ON OUR DASH BOARD.

[CLICK HERE](#)

Performance Data and Graphs	Data
	Graphs
	S-Parameter (S2P Files) Data Set (.zip file) De-embedded to device pads
Case Style	UC2731 Lead Finish: Gold over Nickel plate.
RoHS Status	Compliant
Tape and Reel	TR-F003
Suggested Layout for PCB Design	PL-652
Evaluation Board	TB-ALF-5000+
	Gerber File
Environmental Rating	ENV120

### NOTES

- A. Performance and quality attributes and conditions not expressly stated in this specification document are intended to be excluded and do not form a part of this specification document.
- B. Electrical specifications and performance data contained in this specification document are based on Mini-Circuits' applicable established test performance criteria and measurement instructions.
- C. The parts covered by this specification document are subject to Mini-Circuits' standard limited warranty and terms and conditions (collectively, "Standard Terms"); Purchasers of this part are entitled to the rights and benefits contained therein. For a full statement of the standard terms and the exclusive rights and remedies thereunder, please visit Mini-Circuits' website at [www.minicircuits.com/terms/viewterm.html](http://www.minicircuits.com/terms/viewterm.html)



# Thin-Film Lowpass Filter

# ALF-5000+

## Typical Performance Data

FREQ.	Insertion Loss	Input Return Loss	Output Return Loss	FREQ.	Group Delay
(MHz)	(dB)	(dB)	(dB)	(MHz)	(ns)
10	0.10	38.50	38.33	10	0.12
20	0.10	37.73	37.78	20	0.13
25	0.10	37.43	37.41	25	0.14
50	0.10	36.20	36.17	50	0.14
75	0.10	34.97	35.01	75	0.14
100	0.10	33.96	33.95	100	0.14
125	0.11	33.04	33.05	125	0.14
150	0.11	32.25	32.23	150	0.14
175	0.11	31.54	31.56	175	0.14
200	0.12	30.95	30.90	200	0.14
300	0.14	29.07	28.76	225	0.14
400	0.15	27.83	27.40	250	0.14
500	0.17	26.98	26.41	300	0.14
600	0.19	26.45	25.70	400	0.13
700	0.20	26.00	25.14	500	0.13
800	0.20	25.65	24.64	600	0.13
900	0.21	25.29	24.19	700	0.13
1000	0.22	24.98	23.84	800	0.13
1100	0.23	24.61	23.49	900	0.14
1200	0.23	24.26	23.20	1000	0.14
1300	0.24	23.82	22.89	1100	0.14
1400	0.25	23.41	22.65	1200	0.14
1500	0.25	22.98	22.42	1300	0.14
1600	0.26	22.56	22.23	1400	0.14
1700	0.27	22.16	22.04	1500	0.14
1800	0.28	21.81	21.94	1600	0.14
1900	0.28	21.52	21.87	1700	0.14
2000	0.29	21.28	21.83	1800	0.14
2200	0.30	21.03	22.00	1900	0.14
2500	0.32	21.42	22.84	2000	0.14
2800	0.34	23.18	25.01	2100	0.14
3000	0.34	25.52	27.66	2200	0.15
4000	0.51	19.46	20.27	2300	0.15
5000	0.82	21.23	24.40	2400	0.15
5770	3.05	10.09	9.61	2500	0.15
5800	3.53	8.50	8.16	2600	0.15
6000	9.04	3.04	2.98	2700	0.15
6100	12.74	2.12	2.10	2800	0.15
6300	20.87	1.41	1.40	2900	0.16
6500	30.31	1.18	1.16	3000	0.16
6700	44.65	1.08	1.05	3100	0.16
7500	41.00	1.03	0.97	3200	0.16
8000	47.93	1.06	1.02	3300	0.17
9000	47.04	1.09	1.17	3400	0.17
9500	43.13	1.06	1.21	3500	0.17
10000	41.34	1.03	1.20	3600	0.18
10500	40.49	0.99	1.17	3700	0.18
11000	40.25	0.98	1.13	3800	0.18
11500	40.35	1.01	1.10	3900	0.19
12000	40.67	1.07	1.11	4000	0.19
12500	41.09	1.14	1.14	4100	0.19
13000	41.44	1.22	1.19	4200	0.20
13500	41.94	1.27	1.28	4300	0.21
14000	43.36	1.29	1.45	4400	0.21
14500	45.77	1.28	1.87	4500	0.22
15000	31.83	1.28	4.07	4600	0.23
15500	24.33	1.28	4.54	4700	0.24
16000	25.50	1.29	2.40	4800	0.26
16500	26.28	1.33	2.30	4900	0.27
17000	27.00	1.42	2.31	5000	0.28

Typical Performance Curves

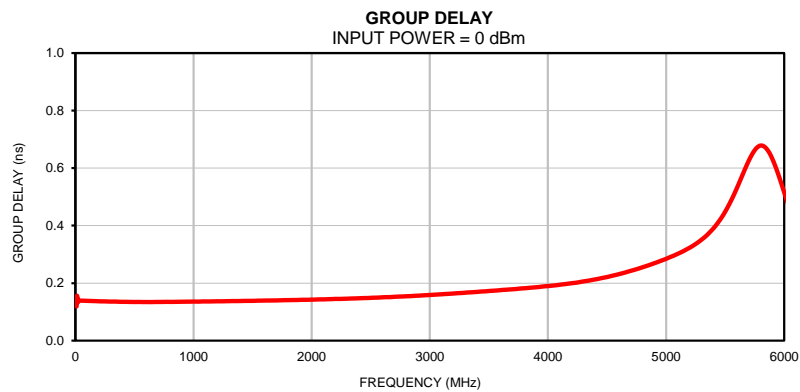
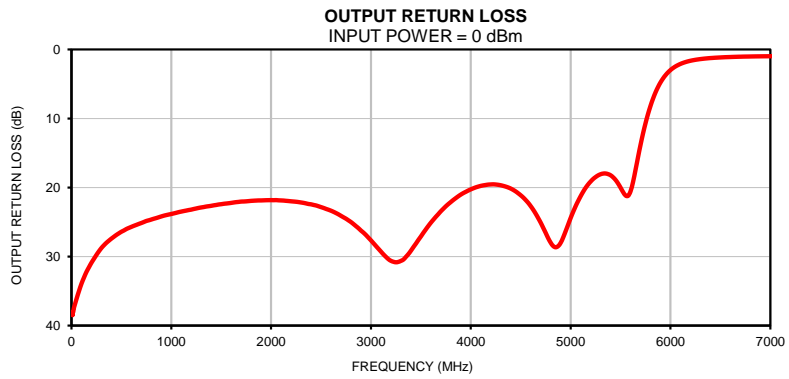
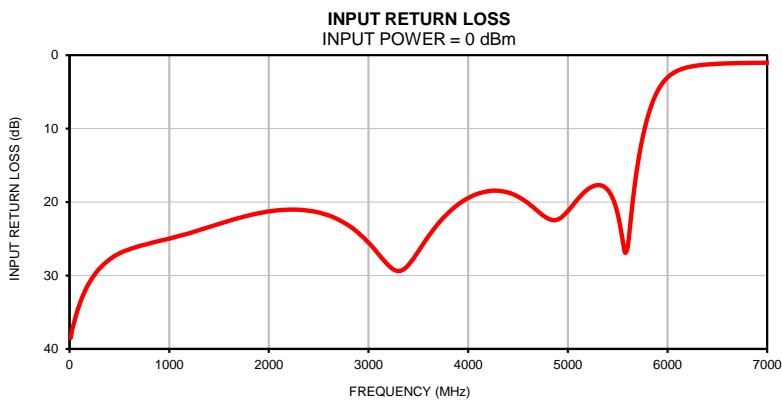
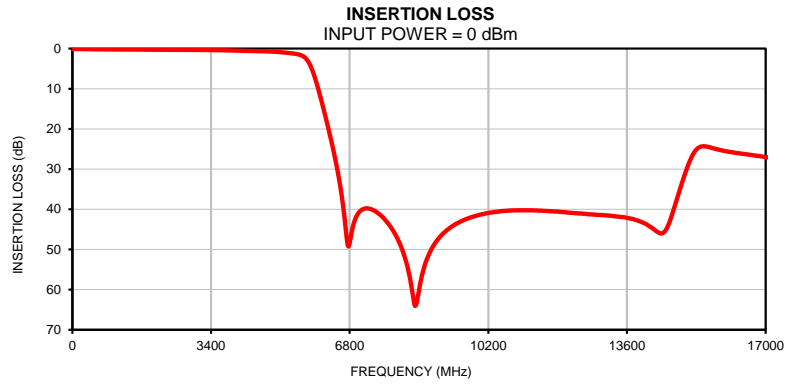



## Outline Dimensions

## UC2731

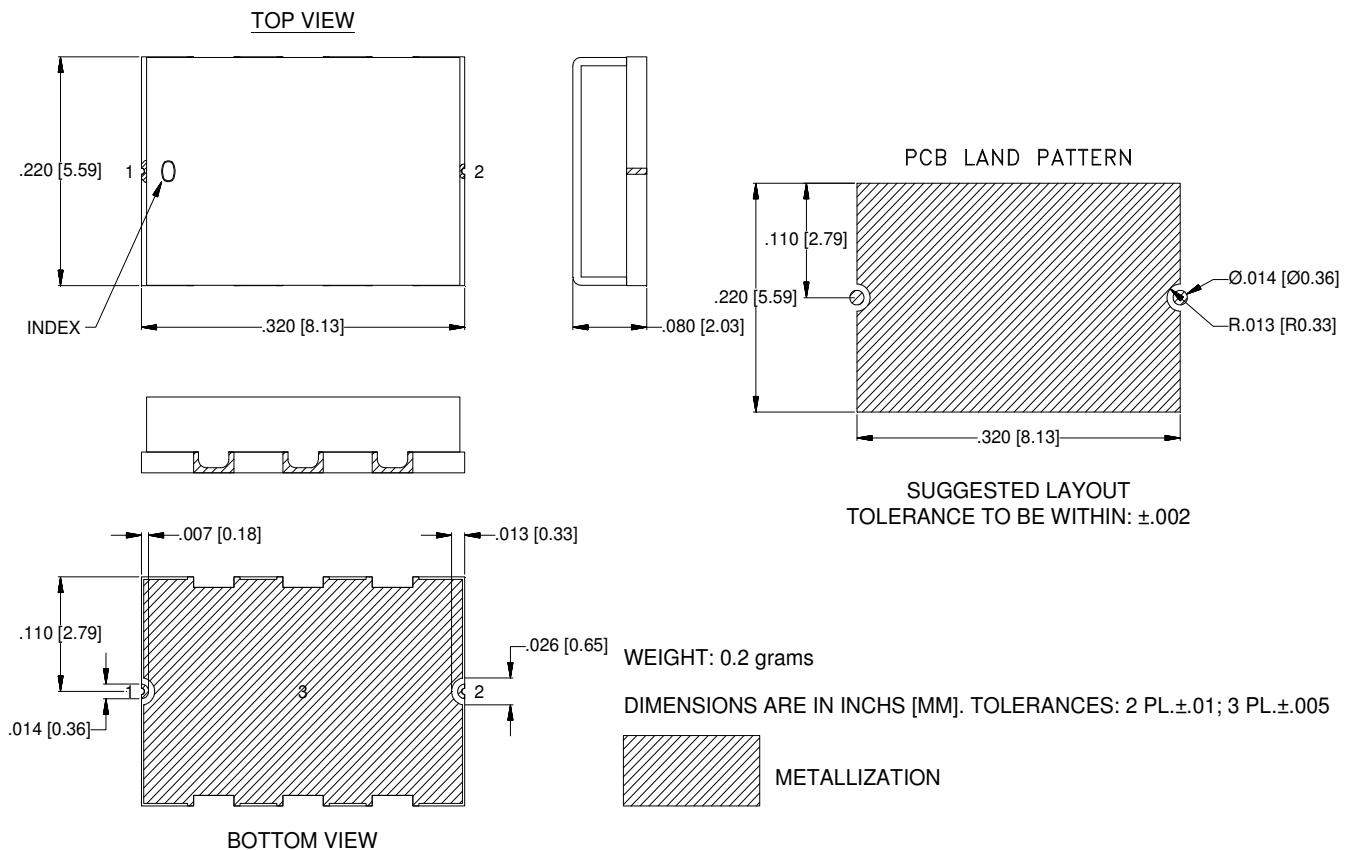

### Notes:

1. Case material: Gold over Nickel over Annealed Stainless Steel.
2. Base: Ceramic
3. Termination finish: **as shown below or indicated on Data Sheet.**  
For RoHS Case Styles: Gold over Nickel plate. All models, (+) suffix.



P.O. Box 350166, Brooklyn, New York 11235-0003 (718) 934-4500 Fax (718) 332-4661 For detailed performance specs & shopping online see Mini-Circuits web site



The Design Engineers Search Engine Provides ACTUAL Data Instantly From MINI-CIRCUITS At: [www.minicircuits.com](http://www.minicircuits.com)

RF/IF MICROWAVE COMPONENTS

THIRD ANGLE PROJECTION

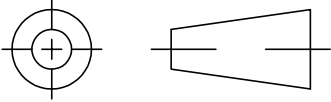

REVISIONS

REV	ECN No.	DESCRIPTION	DATE	DR	AUTH
OR	ECO-007104	NEW RELEASE	MAR 21	DDR	VC
A	ECO-010633	UPDATED AS PER CURRENT TEST BOARD	NOV 21	DDR	VC
B	ECO-019739	UPDATED TRACE AND SPACE WIDTH	OCT 23	LK	VC
		TOLERANCE ONLY NO OTHER CHANGES			

## SUGGESTED MOUNTING CONFIGURATION FOR UC2731 CASE STYLE

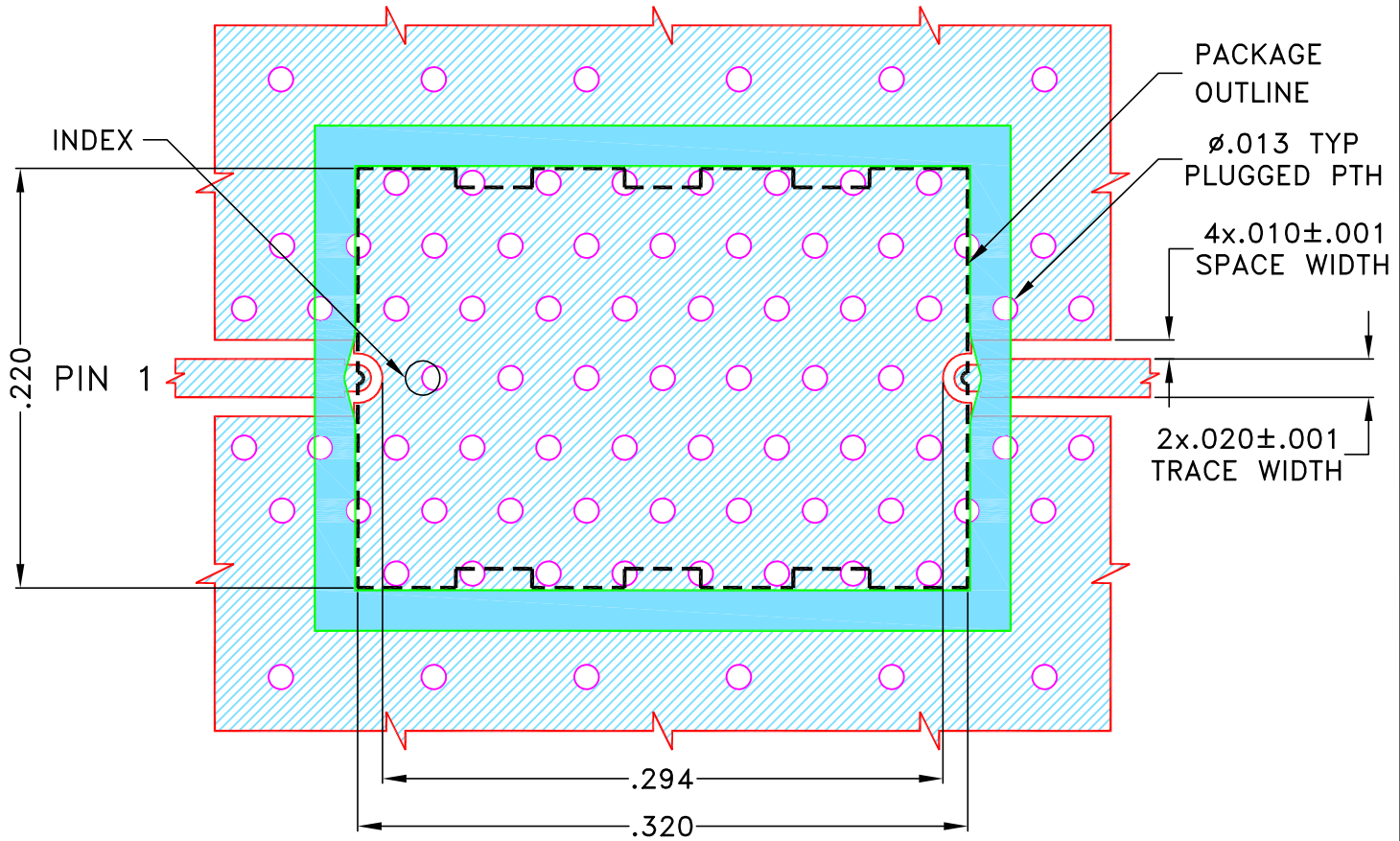

### NOTES:

1. COPLANAR WAVEGUIDE PARAMETERS ARE SHOWN FOR ROGERS (R04350B) WITH DIELECTRIC THICKNESS  $.010 \pm .0010$ . COPPER: 1/2 Oz. EACH SIDE.  
FOR OTHER MATERIALS TRACE WIDTH AND GAP MAY NEED TO BE MODIFIED.
2. BOTTOM SIDE OF THE PCB IS CONTINUOUS GROUND PLANE.

DENOTES PCB COPPER PATTERN WITH SMOBC (SOLDER MASK OVER BARE COPPER)  
 DENOTES PCB COPPER PATTERN FREE OF SOLDERMASK

UNLESS OTHERWISE SPECIFIED	INITIALS	DATE
DIMENSIONS ARE IN INCHES	DRAWN DDR	29 MAR 21
TOLERANCES ON:	CHECKED RR	29 MAR 21
2 PL DECIMALS ±	APPROVED NN	29 MAR 21
3 PL DECIMALS ± .005		
ANGLES ±		
FRACTIONS ±		

**Mini-Circuits®** 13 Neptune Avenue  
 Brooklyn NY 11235

PL DWG, UC2731 C.S, 50 OHM, ABF

SIZE <b>A</b>	CODE IDENT <b>15542</b>	DRAWING NO: <b>98-PL-652</b>	REV: <b>B</b>
FILE: <b>98-PL-652</b>	SCALE: <b>10:1</b>	SHEET: <b>1 OF 1</b>	

THIS DOCUMENT AND ITS CONTENTS ARE THE PROPERTY OF MINI-CIRCUITS. EXCEPT FOR USE EXPRESSLY GRANTED, IN WRITING, TO ITS VENDORS, VENDEE AND THE UNITED STATES GOVERNMENT, MINI-CIRCUITS RESERVES ALL PROPRIETARY DESIGN, USE, MANUFACTURING AND REPRODUCTION RIGHTS THERETO. THESE CONTENTS SHALL NOT BE USED, DUPLICATED OR DISCLOSED TO ANY OUTSIDE PARTY, IN WHOLE OR IN PART, WITHOUT WRITTEN PERMISSION OF MINI-CIRCUITS.

# Evaluation Board and Circuit

TB-ALF-5000+

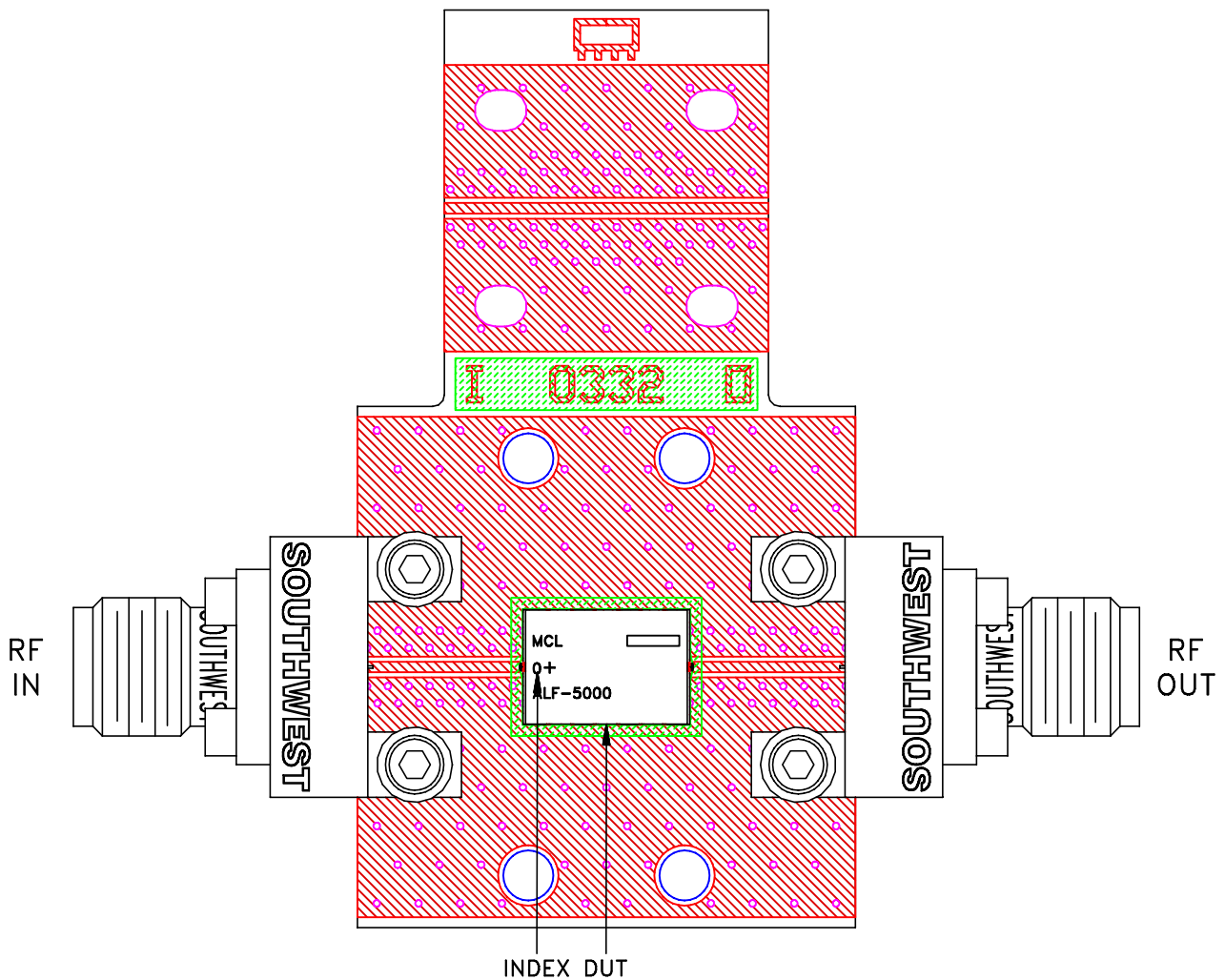

Schematic diagram

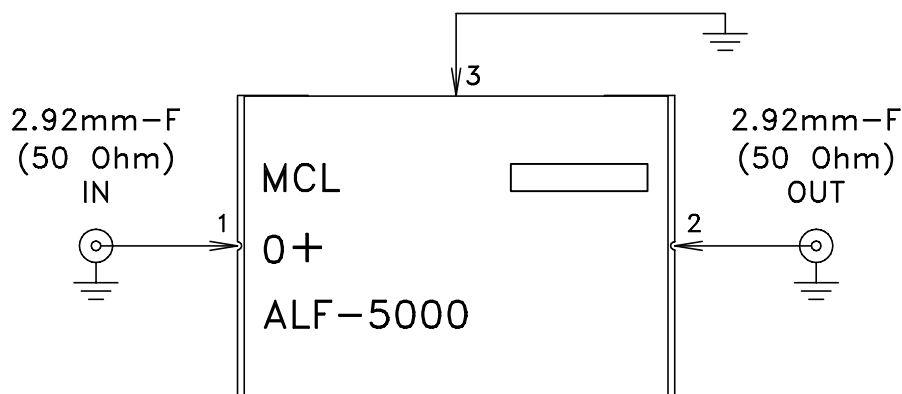

**Notes:**

1. PCB Material: ROGERS (R04350B) OR Equivalent, Dielectric Constant=3.48±.05  
Dielectric Thickness: .010±.001 inch
2. 50 Ohm 2.92mm Female Connectors.

 **Mini-Circuits®**

All Mini-Circuits products are manufactured under exacting quality assurance and control standards, and are capable of meeting published specifications after being subjected to any or all of the following physical and environmental test.

<b>Specification</b>	<b>Test/Inspection Condition</b>	<b>Reference/Spec</b>
Operating Temperature	-55° to 125° C Ambient Environment	Individual Model Data Sheet
Storage Temperature	-55° to 125° C Ambient Environment	Individual Model Data Sheet
Solderability	10X Magnification	J-STD-002, Para 4.2.5, Test S, 95% Coverage
Thermal Shock	-55° to 125°C, 100 cycles	MIL-STD-202, Method 107, Condition A-3, Except +125°C