



THIN FILM SURFACE MOUNT

Bandpass Filter

ABF-13G+

50Ω

11.6 to 14.4 GHz

KEY FEATURES

- Low Passband Insertion Loss of 1.1 dB Typ.
- High Rejection of 55 dB Typ.
- Good Return Loss of 14 dB Typ.
- Small Size, 5.59 x 8.13 x 2.03 mm

APPLICATIONS

- X-Band Radar
- Test and Measurements

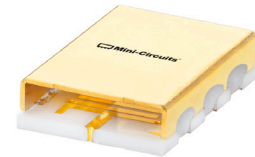

Generic photo used for illustration purposes only

PRODUCT OVERVIEW

Mini-Circuits' Surface Mount Thin-Film filters offer low insertion loss and high rejection realized via Thin-Film on Alumina substrate, using a sputtering process that can guarantee an enhanced Q and repeatable performance. Low pass, high pass, and bandpass surface mount thin-film designs can be realized with this technology up to 40 GHz in a small form factor helping customers achieve their SWaP objectives. Using our high quality thin-film manufacturing process we can guarantee repeatability on large batches of filters.

FUNCTIONAL DIAGRAM

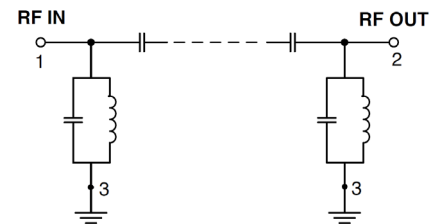

ELECTRICAL SPECIFICATIONS^{1,2,3} AT +25°C

Parameter	F#	Frequency (GHz)	Min.	Typ.	Max.	Units
Pass Band	Center Frequency ⁴	—	—	13	—	GHz
	Insertion Loss	F1-F2	11.6 - 14.4	1.1	2.5	dB
	Return Loss	F1-F2	11.6 - 14.4	—	14	dB
Stopband, Lower	Rejection	DC-F3	DC - 7.5	40	55	dB
		F3-F4	7.5 - 9	20	40	dB
Stopband, Upper	Rejection	F5-F6	17 - 18	30	41	dB
		F6-F7	18 - 27	25	32	dB
		F7-F8	27 - 32	—	25	—

1. Tested on Evaluation Board P/N TB-ABF-13G+ with feedline losses removed by normalization of S12 and S21 traces to measurement of TB thru-line.

2. This filter is bi-directional RF1 and RF2 ports may be interchanged, see S-Parameters for actual performance.

3. This component is not intended for use as a DC-blocking circuit element. In applications where DC voltage and/or current is present at either the input or output ports, external DC blocking capacitors are required.

4. Typical variation ±3%.

ABSOLUTE MAXIMUM RATINGS⁵

Parameter	Ratings
Operating Temperature	-55°C to +125°C
Storage Temperature	-55°C to +125°C
Input Power ⁶	9.5 W Max. at 25°C

5. Permanent damage may occur if any of these limits are exceeded.

6. Power rating applies only to signals within the passband. Derated power at +125°C is 2.9 W

TYPICAL FREQUENCY RESPONSE AT +25°C

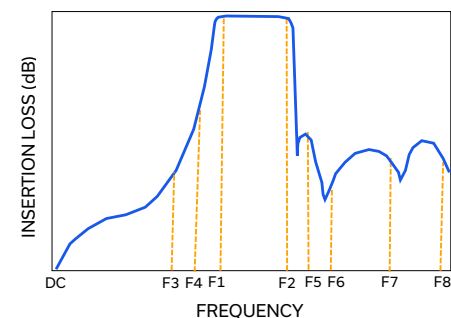



THIN FILM SURFACE MOUNT

Bandpass Filter

ABF-13G+

Mini-Circuits

50Ω

11.6 to 14.4 GHz

TYPICAL PERFORMANCE GRAPHS AT +25°C

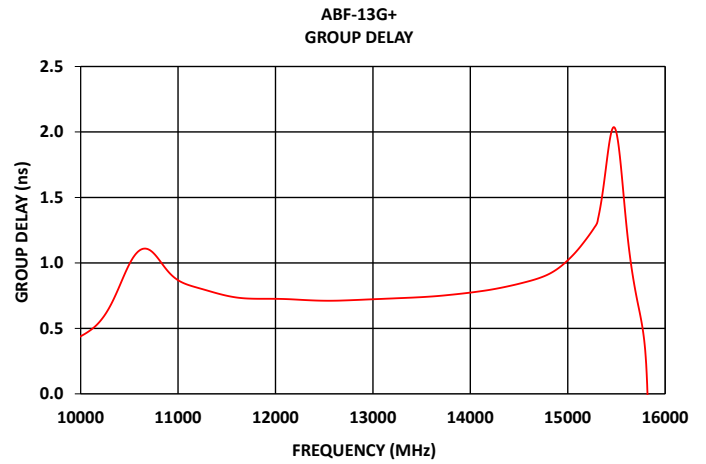
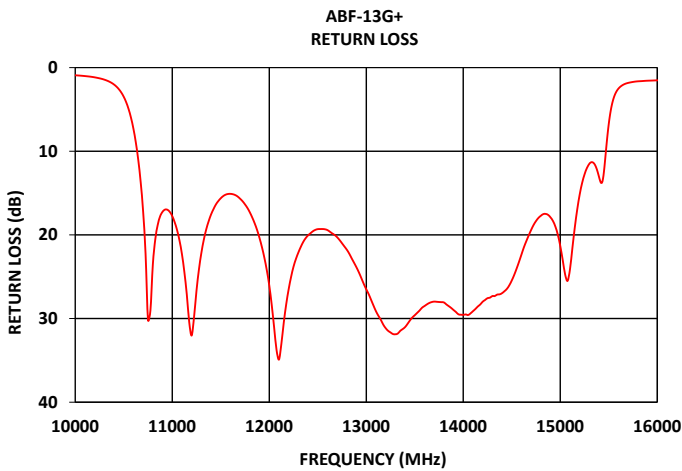
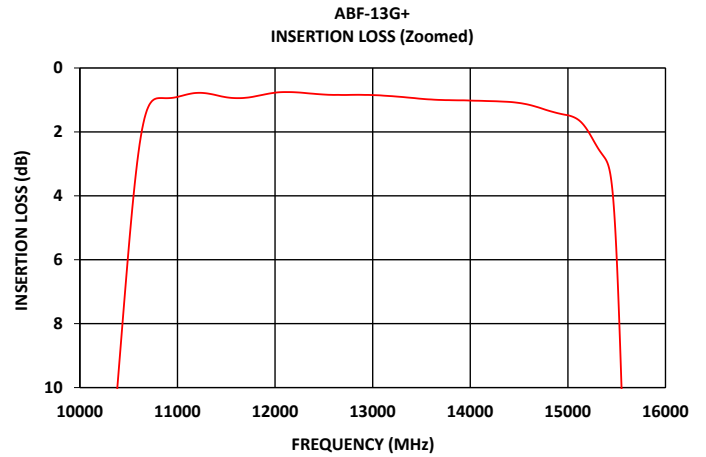
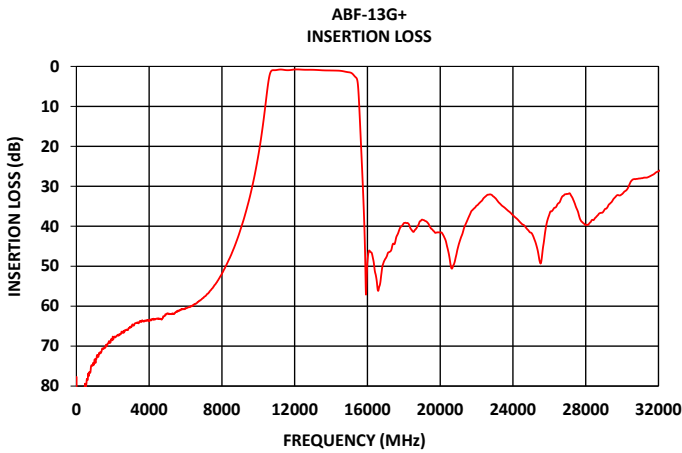



FUNCTIONAL DIAGRAM

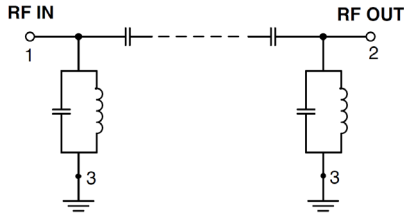
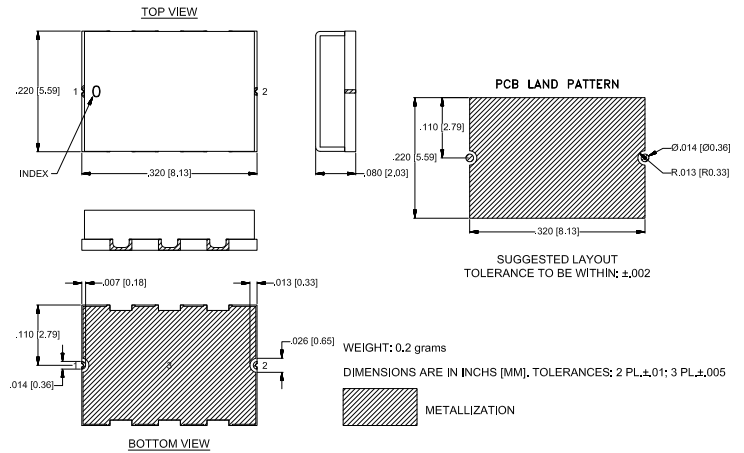

Figure 1. ABF-13G+ Functional Diagram

PAD DESCRIPTION

Function	Pad Number	Description
RF1 ²	1	Connects to RF Input Port
RF2 ²	2	Connects to RF Output Port
GROUND	3	Connects to Ground on PCB, (See drawing PL-764)
NC	—	No connection, not used internally. See drawing PL-764 for connection to PCB

CASE STYLE DRAWING



SUGGESTED PCB LAYOUT (PL-764)

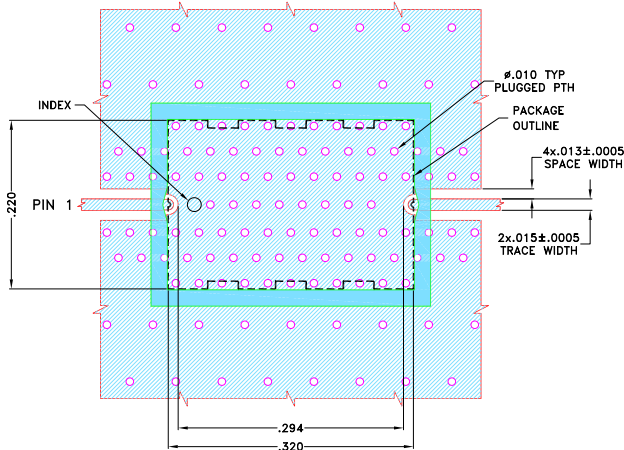

NOTES:

1. COPLANAR WAVEGUIDE PARAMETERS ARE SHOWN FOR ROGERS (RO4350B Lo Pro) WITH DIELECTRIC THICKNESS .0073±.0007. COPPER: 1/2 Oz. EACH SIDE. FOR OTHER MATERIALS TRACE WIDTH AND GAP MAY NEED TO BE MODIFIED.
 2. BOTTOM SIDE OF THE PCB IS CONTINUOUS GROUND PLANE.
- DENOTES PCB COPPER PATTERN WITH SMOBC (SOLDER MASK OVER BARE COPPER)
■ DENOTES PCB COPPER PATTERN FREE OF SOLDERMASK

Figure 2. Suggested PCB Layout PL-764

PRODUCT MARKING*: ABF-13G

*Marking may contain other features or characters for internal lot control.



RECOMMENDED PCB LAYOUT PATTERN FOR FILTER

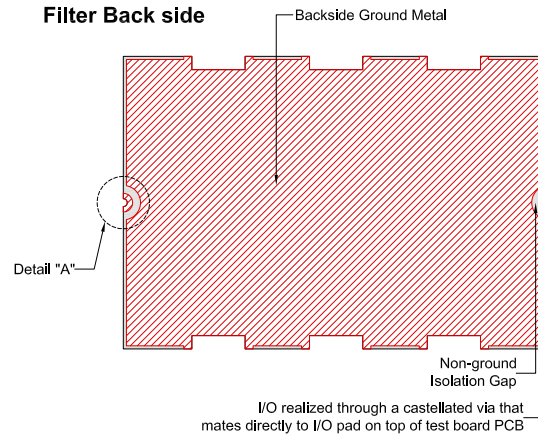

Filter RF I/O Detail (Filter Back Side)

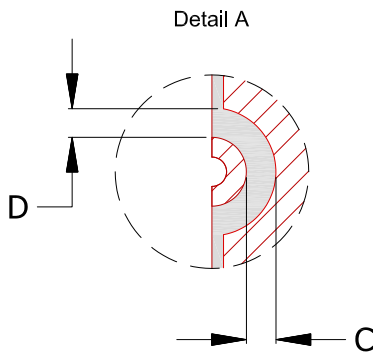

PCB Pattern Recommendations

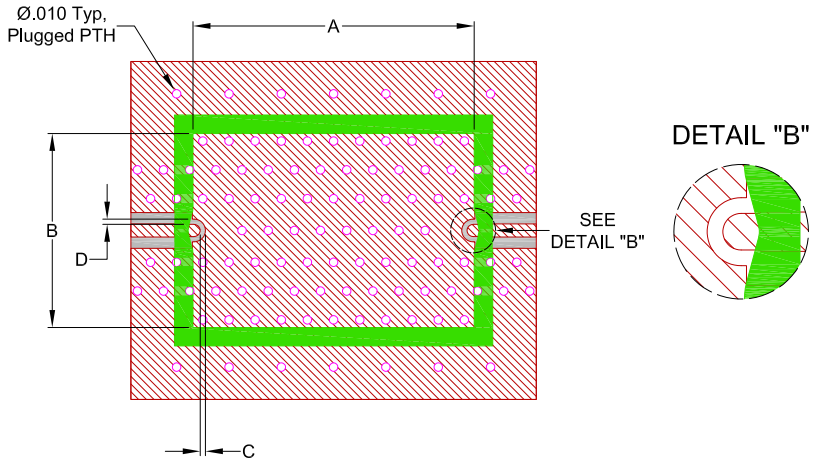

- 1) Customer PCB's ground pattern length (dimension A) can be similar to filter length.
- 2) Customer PCB's ground pattern width (dimension B) can be similar to filter width.
- 3) Dimensions C and D on Filter RF I/O detail and Customer PCB pattern can be closely match. The dimensions of C and D on the Customer PCB pattern can be slightly larger to account for component alignment tolerance (ground metal can be pulled back from RF I/O trace).
- 4) Recommend to use Solder mask at Customer PCB at outer area of filter pattern/ footprint with a clearance of about 1.25mil at each side. (Tighter registration tolerance required for solder mask)
- 5) Recommended to use Solder mask at I/O of Customer PCB as per above diagram (refer detail B).



COMMENTS ON COMPONENT HANDLING AND SOLDER ATTACH

- 1) Avoid using soldering iron directly to the ceramic filter. This would lead to development of crack in the component due to thermal shock.
- 2) Vacuum pick-up tool or plastic tweezers are recommended for handling the components. Extra care should be taken not to scratch the filter or metal area.
- 3) Use 2-3 mil thickness stencil plate and screen print the solder. Refer below picture for recommended stencil pattern to get the best solder attachment.

Stencil opening drawing

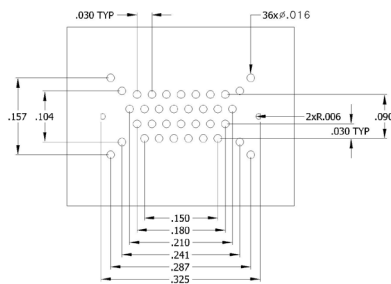

Solder location after screen print

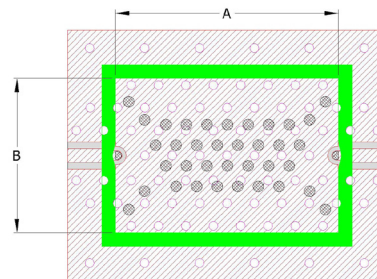

- 4) Plugged ground vias in the PWB will improve attachment consistency.
- 5) Recommended to have a similar or closer test board material and thickness (refer Mini-Circuits evaluation board for details) to minimize the CTE over the temperature range.



THIN FILM SURFACE MOUNT

Bandpass Filter

ABF-13G+

Mini-Circuits

50Ω

11.6 to 14.4 GHz

ADDITIONAL DETAILED INFORMATION IS AVAILABLE ON OUR DASHBOARD.

[CLICK HERE](#)

Performance Data and Graphs	Data
	Graphs
	S-Parameter (S2P Files) Data Set (.zip file) De-embedded to device pads
Case Style	UC2731 Lead Finish: Gold over Nickel Plate.
RoHS Status	Compliant
Tape and Reel	TR-F003
Suggested Layout for PCB Design	PL-764
Evaluation Board	TB-ABF-13G+
	Gerber File
Environmental Rating	ENV120

NOTES

- A. Performance and quality attributes and conditions not expressly stated in this specification document are intended to be excluded and do not form a part of this specification document.
- B. Electrical specifications and performance data contained in this specification document are based on Mini-Circuits' applicable established test performance criteria and measurement instructions.
- C. The parts covered by this specification document are subject to Mini-Circuits' standard limited warranty and terms and conditions (collectively, "Standard Terms"); Purchasers of this part are entitled to the rights and benefits contained therein. For a full statement of the standard terms and the exclusive rights and remedies thereunder, please visit Mini-Circuits' website at www.minicircuits.com/terms/viewterm.html



Thin-Film Bandpass Filter

ABF-13G+

Typical Performance Data

FREQ.	Insertion Loss	Input Return Loss	Output Return Loss	FREQ.	Group Delay
(MHz)	(dB)	(dB)	(dB)	(MHz)	(ns)
10	77.71	0.02	0.04	11600	0.74
20	95.51	0.03	0.05	11625	0.73
25	101.01	0.04	0.05	11650	0.73
100	92.69	0.08	0.09	11675	0.73
200	86.33	0.12	0.14	11700	0.73
400	83.89	0.18	0.20	11725	0.73
800	75.22	0.23	0.25	11750	0.73
900	74.86	0.23	0.25	11775	0.73
1000	73.32	0.23	0.25	11800	0.73
2000	67.61	0.21	0.22	11825	0.73
5000	61.79	0.41	0.44	11850	0.73
7500	55.42	0.67	0.69	11875	0.73
9000	41.14	0.71	0.74	12000	0.73
9650	30.40	0.76	0.78	12025	0.73
10075	20.27	0.98	1.00	12050	0.72
10575	3.28	6.00	6.03	12100	0.72
11600	0.94	15.09	15.36	12150	0.72
11800	0.88	17.31	17.66	12200	0.72
12000	0.77	26.03	26.35	12250	0.72
12400	0.81	20.05	20.49	12300	0.72
12600	0.84	19.42	19.78	12350	0.71
13000	0.85	26.50	24.23	12400	0.71
13500	0.96	29.60	28.40	12450	0.71
13600	0.99	28.51	28.12	12500	0.71
13800	1.01	28.07	27.70	12550	0.71
14000	1.02	29.56	28.76	12600	0.71
14200	1.04	27.98	29.92	12650	0.71
14400	1.06	26.96	31.87	12700	0.71
15000	1.48	21.33	23.37	12750	0.71
15410	3.01	13.51	17.17	12800	0.72
15550	10.03	3.65	4.03	12900	0.72
15670	21.94	1.93	2.08	13000	0.72
15800	35.96	1.64	1.74	13050	0.72
16000	48.99	1.52	1.57	13100	0.73
17000	48.06	1.40	1.32	13150	0.73
17500	44.37	1.38	1.26	13200	0.73
18000	39.23	1.40	1.29	13250	0.73
19500	40.58	1.38	1.46	13300	0.73
20000	41.58	1.41	1.52	13350	0.73
20500	47.55	1.41	1.53	13400	0.73
21000	44.91	1.43	1.52	13450	0.74
21500	38.43	1.48	1.50	13500	0.74
22000	34.86	1.55	1.49	13550	0.74
22500	32.51	1.59	1.50	13600	0.74
23000	32.84	1.55	1.45	13650	0.75
23500	35.20	1.52	1.48	13700	0.75
24000	37.24	1.53	1.57	13750	0.75
24500	39.46	1.60	1.70	13800	0.76
25000	41.64	1.70	1.80	13850	0.76
25500	49.22	1.86	1.88	13900	0.76
26000	37.08	2.06	1.96	13950	0.77
26500	34.24	2.16	2.07	14000	0.77
27000	31.92	2.14	2.17	14050	0.78
27500	35.56	2.11	2.28	14100	0.78
28000	39.68	2.20	2.47	14150	0.79
28500	38.01	2.46	2.70	14200	0.79
29000	36.13	2.67	2.93	14250	0.80
30000	31.96	3.04	3.92	14300	0.81
31000	28.04	2.53	2.28	14350	0.82
32000	26.23	2.46	2.60	14400	0.82



P.O. Box 350166, Brooklyn, New York 11235-0003 (718) 934-4500 • Fax (718) 332-4661 For detailed performance specs & shopping online see Mini-Circuits web site

The Design Engineers Search Engine Provides ACTUAL Data Instantly From MINI-CIRCUITS At: www.minicircuits.com

IF/RF MICROWAVE COMPONENTS

Typical Performance Curves

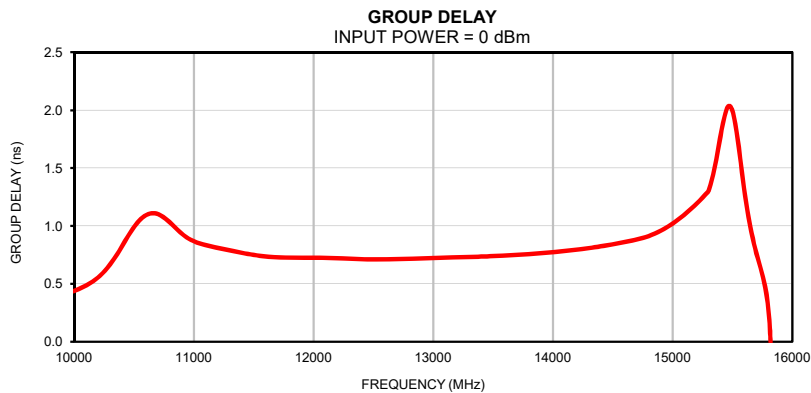
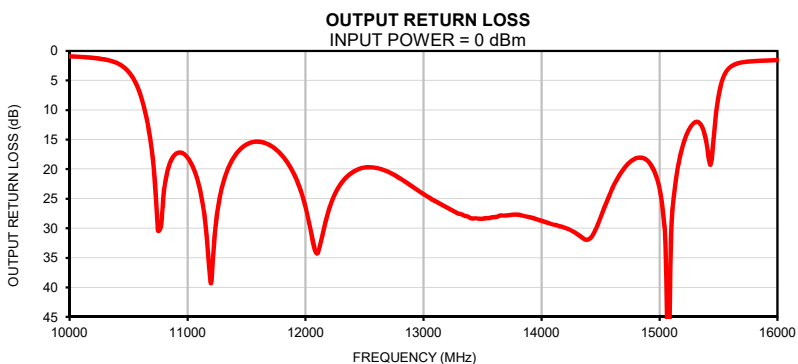
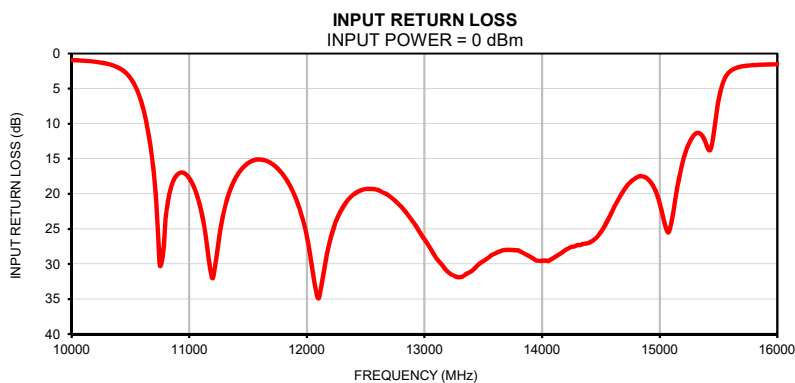
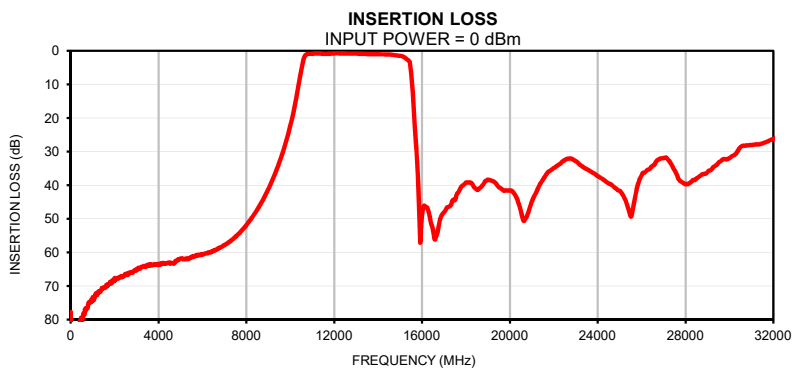

Outline Dimensions

UC2731

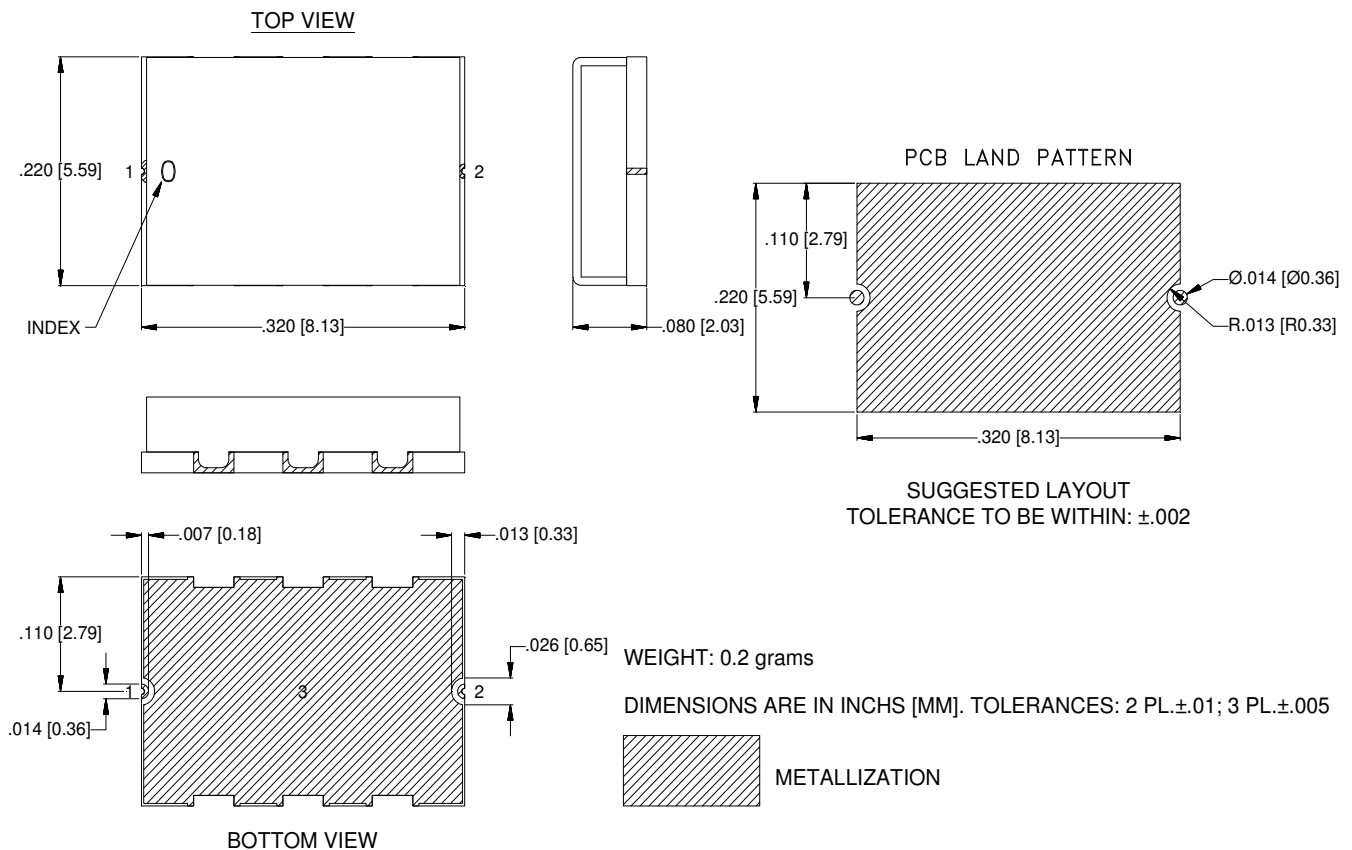

Notes:

1. Case material: Gold over Nickel over Annealed Stainless Steel.
2. Base: Ceramic
3. Termination finish: **as shown below or indicated on Data Sheet.**
For RoHS Case Styles: Gold over Nickel plate. All models, (+) suffix.



P.O. Box 350166, Brooklyn, New York 11235-0003 (718) 934-4500 Fax (718) 332-4661 For detailed performance specs & shopping online see Mini-Circuits web site



The Design Engineers Search Engine Provides ACTUAL Data Instantly From MINI-CIRCUITS At: www.minicircuits.com

RF/IF MICROWAVE COMPONENTS

Tape & Reel Packaging TR-F003

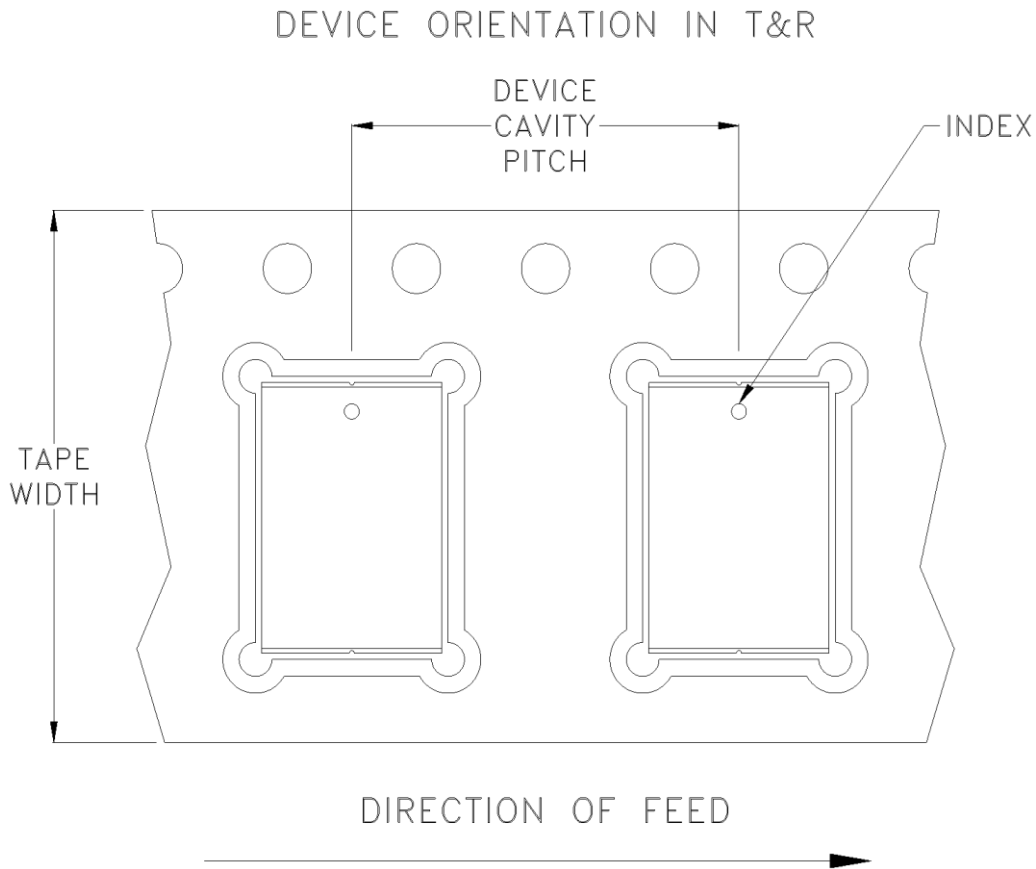

Tape Width, mm	Device Cavity Pitch, mm	Real Size, inches	Devices per Reel See note
16	12	7	10
			20
			50
			100
			200
		13	500

Note: Please consult individual model data sheet/dashboard to determine device per reel availability.

Mini-Circuits carrier tape materials provide protection from ESD (Electro-Static Discharge) during handling and transportation. Tapes are static dissipative and comply with industry standards EIA-481/EIA-541.

Go to: www.minicircuits.com/pages/pdfs/tape.pdf



Distribution Centers NORTH AMERICA 800-654-7949 • 417-335-5935 • Fax 417-335-5945 • EUROPE 44-1252-832600 • Fax 44-1252-837010

Mini-Circuits ISO 9001 & ISO 14001 Certified

INTERNET <http://www.minicircuits.com>

P.O. Box 350166, Brooklyn, New York 11235-0003 (718) 934-4500 Fax (718) 332-4661

THIRD ANGLE PROJECTION

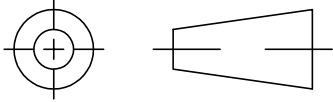

REVISIONS

REV	ECN No.	DESCRIPTION	DATE	DR	AUTH
OR	NPO-003903	NEW RELEASE	OCT 23	LK	VC

**SUGGESTED MOUNTING CONFIGURATION
FOR UC2731 CASE STYLE**

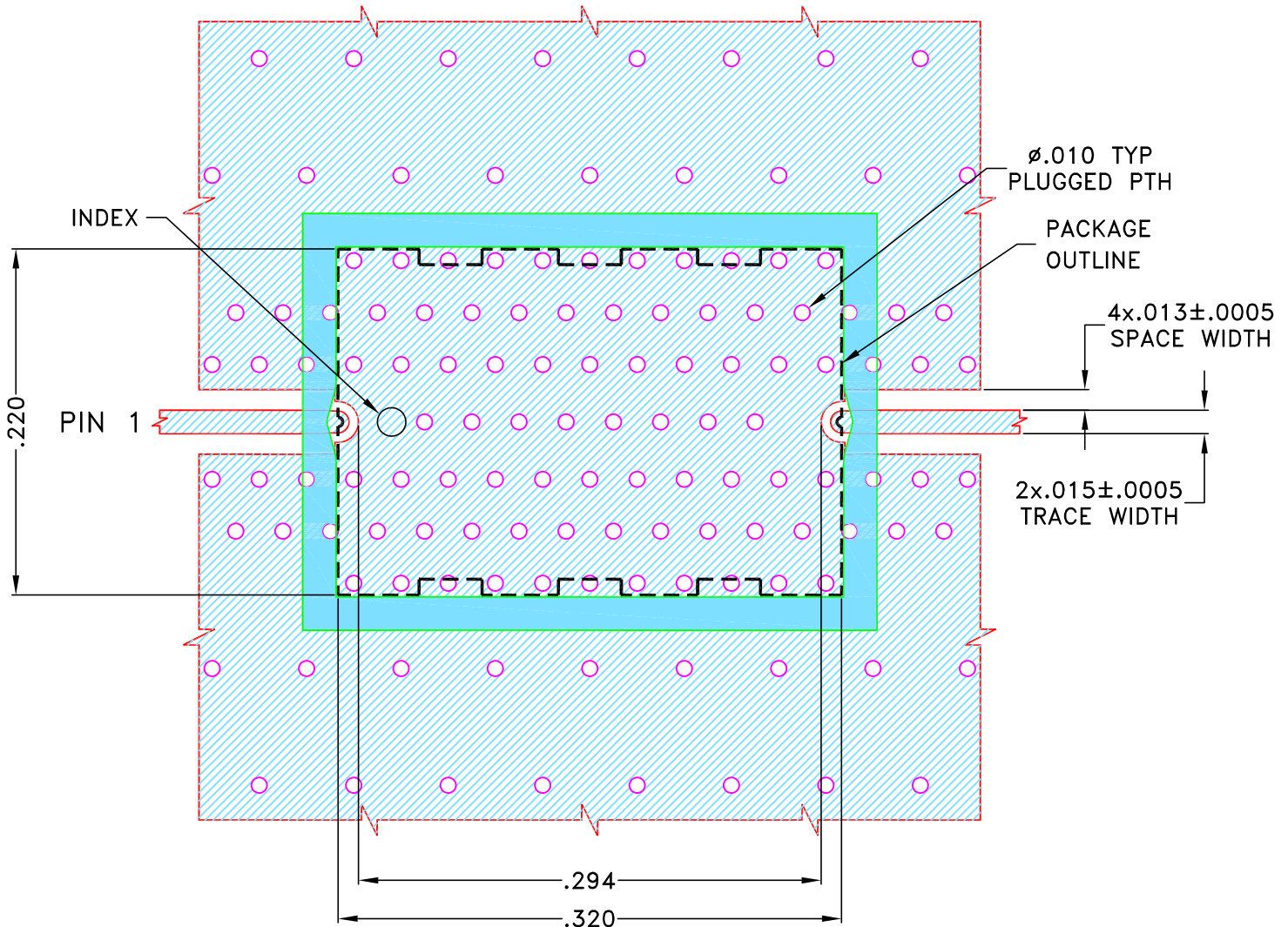

NOTES:

1. COPLANAR WAVEGUIDE PARAMETERS ARE SHOWN FOR ROGERS (R04350B Lo Pro) WITH DIELECTRIC THICKNESS $.0073 \pm .0007$. COPPER: 1/2 Oz. EACH SIDE.
FOR OTHER MATERIALS TRACE WIDTH AND GAP MAY NEED TO BE MODIFIED.
2. BOTTOM SIDE OF THE PCB IS CONTINUOUS GROUND PLANE.

- DENOTES PCB COPPER PATTERN WITH SMOBC (SOLDER MASK OVER BARE COPPER)
- DENOTES PCB COPPER PATTERN FREE OF SOLDERMASK

UNLESS OTHERWISE SPECIFIED	INITIALS	DATE
DIMENSIONS ARE IN INCHES	DRAWN LK	09 OCT 23
TOLERANCES ON:	CHECKED MD	09 OCT 23
2 PL DECIMALS ±	APPROVED RR	13 OCT 23
3 PL DECIMALS ± .005		
ANGLES ±		
FRACTIONS ±		

Mini-Circuits® 13 Neptune Avenue
Brooklyn NY 11235

PL DWG, UC2731 C.S, 50 OHM, ALF

Mini-Circuits®
THIS DOCUMENT AND ITS CONTENTS ARE THE PROPERTY OF MINI-CIRCUITS. EXCEPT FOR USE EXPRESSLY GRANTED, IN WRITING, TO ITS VENDORS, VENDEE AND THE UNITED STATES GOVERNMENT, MINI-CIRCUITS RESERVES ALL PROPRIETARY DESIGN, USE, MANUFACTURING AND REPRODUCTION RIGHTS THERETO. THESE CONTENTS SHALL NOT BE USED, DUPLICATED OR DISCLOSED TO ANY OUTSIDE PARTY, IN WHOLE OR IN PART, WITHOUT WRITTEN PERMISSION OF MINI-CIRCUITS.

ASHEETA1.DWG REV:A DATE:01/12/95

SIZE	CODE IDENT	DRAWING NO:	REV:
A	15542	98-PL-764	OR
FILE:	98-PL-764	SCALE:	9.1:1 SHEET: 1 OF 1

Evaluation Board and Circuit

TB-ABF-13G+

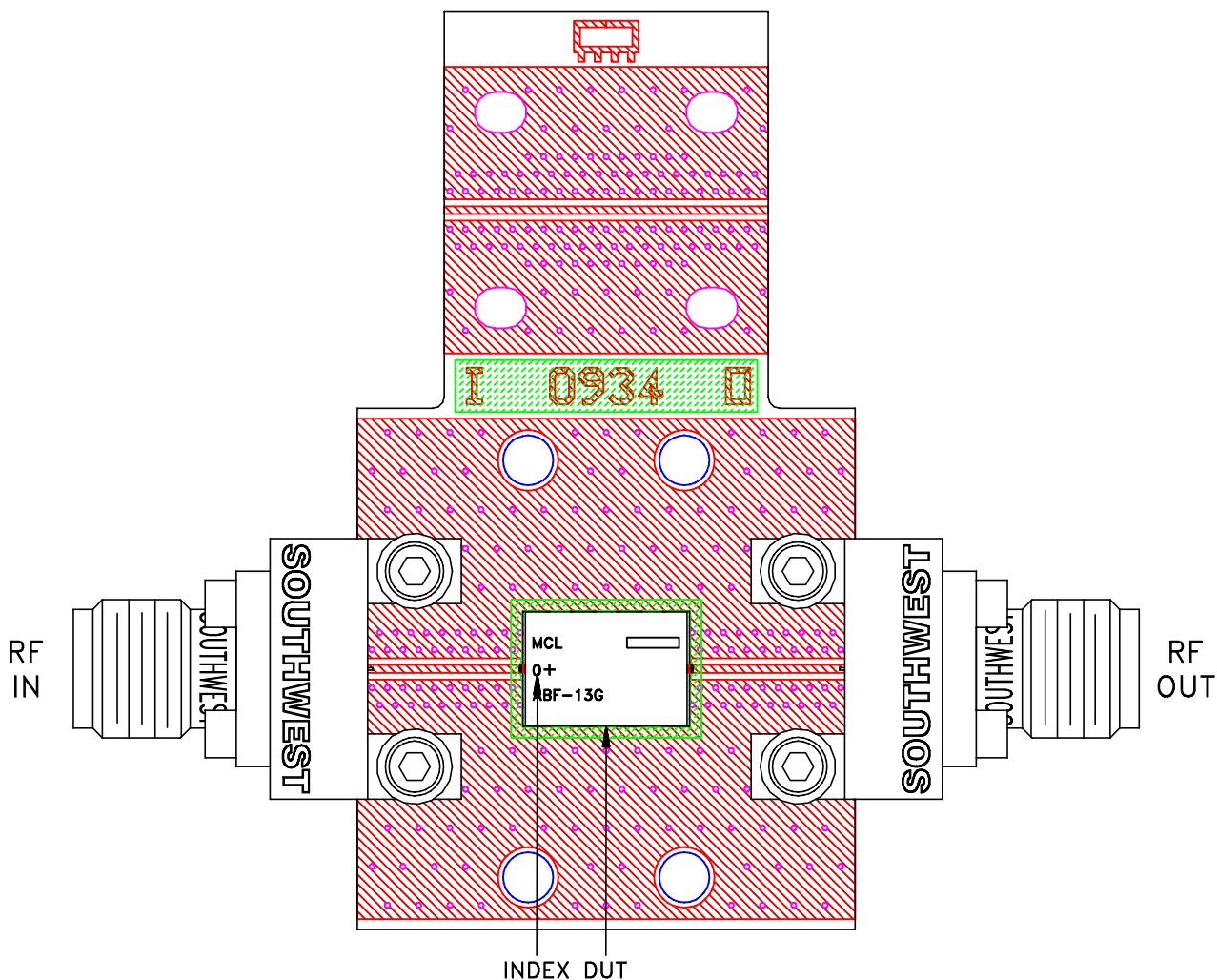

Schematic diagram

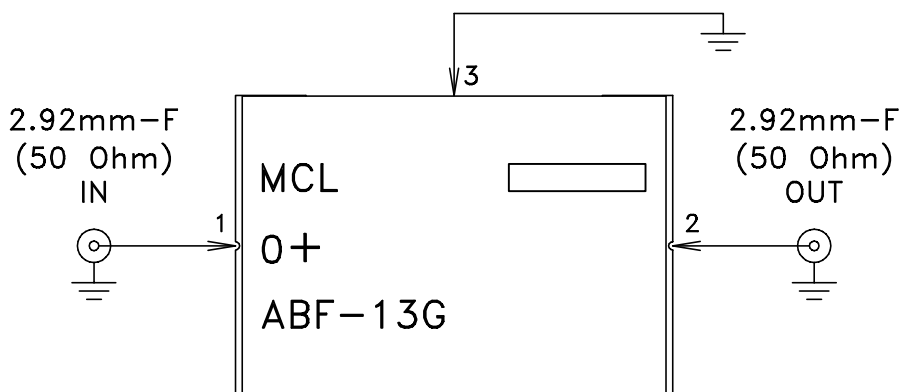

Notes:

1. PCB Material: ROGERS (R04350B Lo Pro) OR Equivalent, Dielectric Constant=3.48±.05
Dielectric Thickness: .0073±.0007 inch
2. 50 Ohm 2.92mm Female Connectors.

 **Mini-Circuits®**

All Mini-Circuits products are manufactured under exacting quality assurance and control standards, and are capable of meeting published specifications after being subjected to any or all of the following physical and environmental test.

Specification	Test/Inspection Condition	Reference/Spec
Operating Temperature	-55° to 125° C Ambient Environment	Individual Model Data Sheet
Storage Temperature	-55° to 125° C Ambient Environment	Individual Model Data Sheet
Solderability	10X Magnification	J-STD-002, Para 4.2.5, Test S, 95% Coverage
Thermal Shock	-55° to 125°C, 100 cycles	MIL-STD-202, Method 107, Condition A-3, Except +125°C