



Coaxial Cable

141-5SMNM+

Mini-Circuits

50Ω 5 inch DC to 18 GHz SMA-Male to N-Male

THE BIG DEAL

- Wideband frequency coverage, DC to 18 GHz
- Low Loss, 0.8 dB at 18 GHz
- Excellent Return Loss, 27 dB at 18 GHz
- Hand formable to almost any custom shape without special bending tools
- 8mm bend radius for tight installations
- Anti-torque nut prevents cable stress during installation
- Insulated outer jacket standard
- Ideal for interconnect of assembled systems



Generic photo used for illustration purposes only

Model No.	141-5SMNM+
Case Style	KQ1668-5
Connectors	SMA-Male to N-Male

+RoHS Compliant

The +Suffix identifies RoHS Compliance. See our website for methodologies and qualifications

APPLICATIONS

- Replacement for custom bent 0.141" semi-rigid cables
- Communication Receivers and Transmitters
- Military and Aerospace System
- Environmental and Test Chambers

PRODUCT OVERVIEW

141 SMNM+ series Hand-Flex™ coaxial cables are ideal for integrating coaxial components and sub-systems in tight spaces and dense system configurations. SMA to N-Type connection avoids need for an adapter between components with SMA-F and N-F connection ports, reducing system cost and improving reliability. Sturdy, handformable cable construction maintains shape after bending with bend-radius as small as 8 mm. 141 SMNM+ coaxial cables have the advantages of wide frequency range and excellent return loss and insertion loss. Available in a variety of lengths.

KEY FEATURES

Features	Advantages
Hand-Formable	141 SMNM+ series Hand-Flex™ cables avoid the need for cable-bending tools, alleviating the risk of damage during bending processes typical of semi-rigid cable assemblies.
Tight Bend Radius	Capable of bending to radii as small as 8mm, the 141 SMNM+ series is ideal for making connections in tight spaces and dense system assemblies.
Excellent Return Loss	Typical return loss of 25 dB to 6 GHz and 18 dB to 18 GHz makes the 141 SMNM+ series ideal for interconnecting a wide variety of RF components while minimizing VSWR ripple contribution due to mating cables & connectors.
High Power Handling Capability: <ul style="list-style-type: none"> • 546W at 0.5 GHz • 90W at 18 GHz 	Mini-Circuits 141 SMNM+ series cables can support medium to high RF power levels and can be used in the transmit path. (NOTE: power rating at sea-level).
Built-in Anti-torque Nut	Supports the connector bodies during installation, preventing stress to the connector/cable interface.
SMA-Male / N-Male connectors	Eliminates need for adapter when connecting to SMA-F and N-F connectors, reducing cost and improving reliability.





Coaxial Cable

141-5SMNM+

Mini-Circuits

50Ω 5 inch DC to 18 GHz SMA-Male to N-Male

ELECTRICAL SPECIFICATIONS AT +25°C

Parameter	Frequency (GHz)	Min.	Typ.	Max.	Units
Frequency Range		DC	—	18	GHz
Length ¹		5			inches
Insertion Loss	DC - 2	—	0.21	0.26	dB
	2 - 6	—	0.23	0.47	
	6 - 10	—	0.34	0.62	
	10 - 18	—	0.84	0.85	
Return Loss	DC - 2	23	29	—	dB
	2 - 6	23	24	—	
	6 - 10	17	22	—	
	10 - 18	17	19	—	

1. Custom sizes available, consult factory.

ABSOLUTE MAXIMUM RATINGS

Parameter	Ratings
Operating Temperature	-55°C to +105°C
Storage Temperature	-55°C to +105°C
Power Handling at 25°C, Sea Level	546W at 0.5 GHz 387W at 1 GHz 273W at 2 GHz 156W at 6 GHz 121W at 10 GHz 90W at 18 GHz

Permanent damage may occur if any of these limits are exceeded.





HAND FLEX™

Coaxial Cable

141-5SMNM+

Mini-Circuits

50Ω 5 inch DC to 18 GHz SMA-Male to N-Male

CABLE CONSTRUCTION

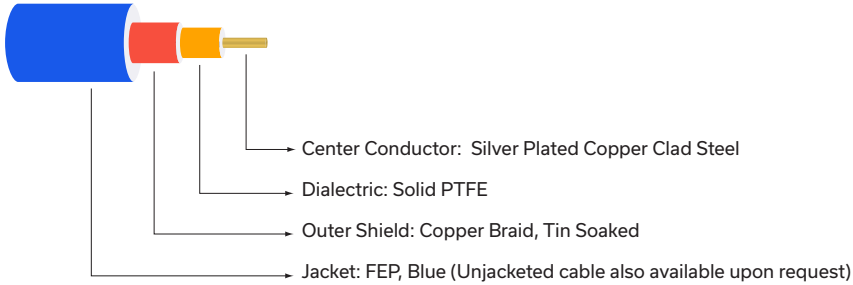

SMA-Male Connector:
 Coupling Nut: Stainless Steel Passivated
 Body: Stainless Steel Gold Plated
 Center Pin: Silver Plated Copper Clad Steel

N-Male Connector:
 Coupling Nut: Brass, Nickel Plated
 Body: Brass, Nickel Plated
 Center Pin: Brass, Gold Plated

OUTLINE DRAWING

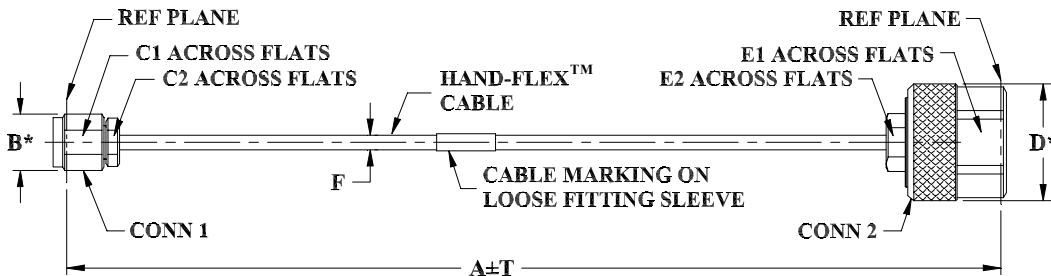

* OVERALL CONNECTOR DIMENSION
 [CONNECTOR SHAPE MAY VARY]

OUTLINE DIMENSIONS (Inch/mm)

A	B	C1	C2	D	E1	E2	F	T	wt
5.0	.36	.313	.250	.88	.750	.375	.163±.004	.05	grams
127.00	9.14	7.95	6.35	22.35	19.05	9.53	4.14±0.10	1.27	39.02

Mini-Circuits



HAND FLEX™

Coaxial Cable

141-5SMNM+

Mini-Circuits

50Ω 5 inch DC to 18 GHz SMA-Male to N-Male

TYPICAL PERFORMANCE DATA AND CHARTS

Frequency (MHz)	Insertion Loss (dB)	Return Loss (dB)	
		SMA-Male	N-Male
100	0.02	42.9	42.1
1000	0.06	47.0	47.9
1800	0.16	37.6	46.7
2404	0.10	30.7	34.2
4001	0.14	33.6	36.7
5000	0.17	29.6	38.5
6000	0.22	26.8	39.3
7001	0.19	27.5	38.7
8001	0.22	35.1	33.1
9000	0.25	37.1	37.1
10000	0.26	37.8	32.6
12001	0.48	24.9	34.2
14001	0.41	25.2	21.5
16242	0.57	27.1	25.3
18000	0.78	35.6	26.7

141-5SMNM+
INSERTION LOSS

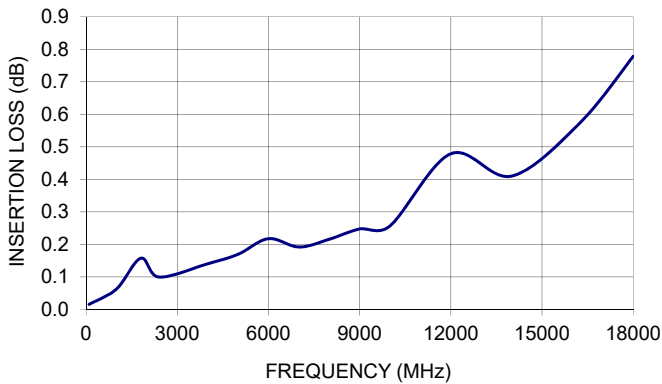

141-5SMNM+
RETURN LOSS

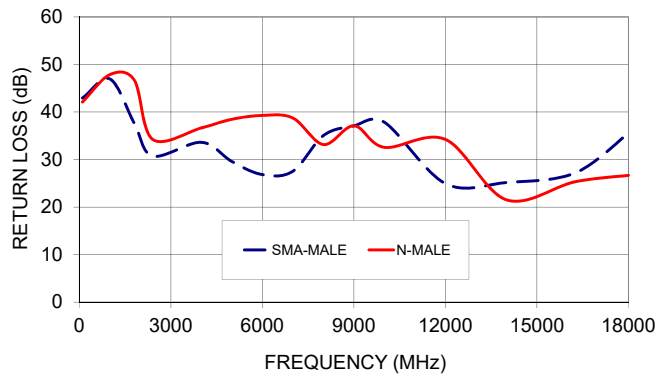



PROPER CABLE CONNECTION USING ANTI-TORQUE NUT

Mini-Circuits 141-series HandFlex™ interconnect cables are constructed with an anti-torque nut adjacent to the connector coupling nut. When used properly, this feature prevents possible damage to the cable due to torquing and twisting when tightening the cable connector.

TO PROPERLY TIGHTEN THE CABLE CONNECTOR:

1) The cable connector includes a coupling nut which rotates to fasten the connector, and an anti-torque nut, which is fixed to prevent the cable from twisting during connection.



2) To properly tighten the cable, use a standard 1/4 inch open end wrench to brace the anti-torque nut.

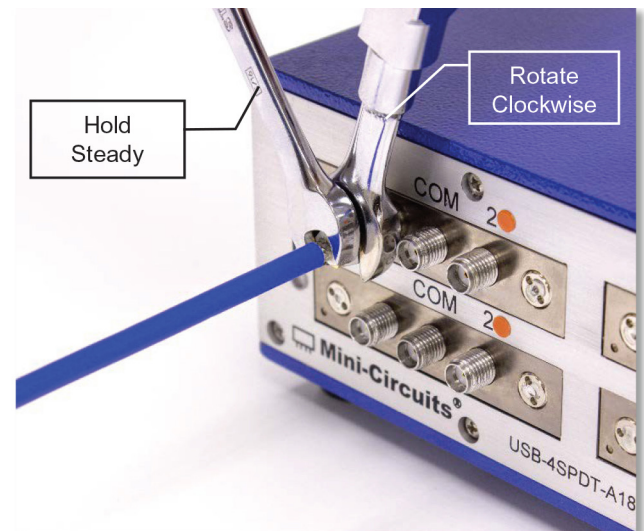

3) Using a 5/16-inch open end wrench, rotate the coupling nut clockwise to tighten the cable connector.

*NOTE: Mini-Circuits recommends using a 5/16-inch open end wrench calibrated to 8 inch-pounds maximum torque to prevent damage due to over-torquing the connector.

NOTES

- A. Performance and quality attributes and conditions not expressly stated in this specification document are intended to be excluded and do not form a part of this specification document.
- B. Electrical specifications and performance data contained in this specification document are based on Mini-Circuit's applicable established test performance criteria and measurement instructions.
- C. The parts covered by this specification document are subject to Mini-Circuits standard limited warranty and terms and conditions (collectively, "Standard Terms"); Purchasers of this part are entitled to the rights and benefits contained therein. For a full statement of the standard terms and the exclusive rights and remedies thereunder, please visit Mini-Circuits' website at www.minicircuits.com/terms/viewterm.html

Typical Performance Data

FREQUENCY (MHz)	INSERTION LOSS (dB)	SMA-MALE RETURN LOSS (dB)	N-MALE RETURN LOSS (dB)
100.0	0.02	42.9	42.1
200.0	0.02	36.8	36.1
300.0	0.03	33.4	32.8
500.0	0.04	30.8	31.4
600.0	0.05	30.7	32.1
800.0	0.06	34.0	38.8
900.0	0.06	38.9	51.7
1000.0	0.06	47.0	47.9
1200.0	0.07	35.8	34.1
1400.0	0.09	31.0	32.1
1600.0	0.19	31.4	34.7
1800.0	0.16	37.6	46.7
2000.0	0.09	43.6	40.7
2200.0	0.10	33.3	34.7
2400.0	0.10	30.8	34.1
2600.0	0.10	32.2	36.8
2800.0	0.10	40.2	39.6
3000.0	0.11	43.5	40.2
3500.0	0.12	32.8	49.7
4000.0	0.14	34.3	36.7
4500.0	0.15	30.4	45.8
5000.0	0.17	29.8	38.8
5500.0	0.19	31.4	42.2
6000.0	0.22	26.8	39.3
6500.0	0.23	24.9	34.7
7000.0	0.19	27.4	39.1
7500.0	0.20	30.2	38.8
8000.0	0.21	35.1	33.0
8500.0	0.22	45.2	30.8
9000.0	0.25	37.3	37.6
9500.0	0.24	32.6	28.3
10000.0	0.26	37.8	32.6
10500.0	0.26	35.6	36.3
11000.0	0.33	30.2	35.3
11500.0	0.41	30.4	30.8
12000.0	0.48	25.1	34.3
12500.0	0.46	28.1	29.7
13000.0	0.44	30.1	34.1
13500.0	0.44	28.9	24.5
14000.0	0.42	25.3	21.9
14500.0	0.41	31.0	20.8
15000.0	0.40	27.4	24.0
15500.0	0.46	32.8	24.0
16000.0	0.52	27.7	24.9
16500.0	0.58	27.8	32.1
17000.0	0.66	29.2	27.9
17500.0	0.75	24.2	32.4
18000.0	0.78	35.6	26.7

Typical Performance Curves

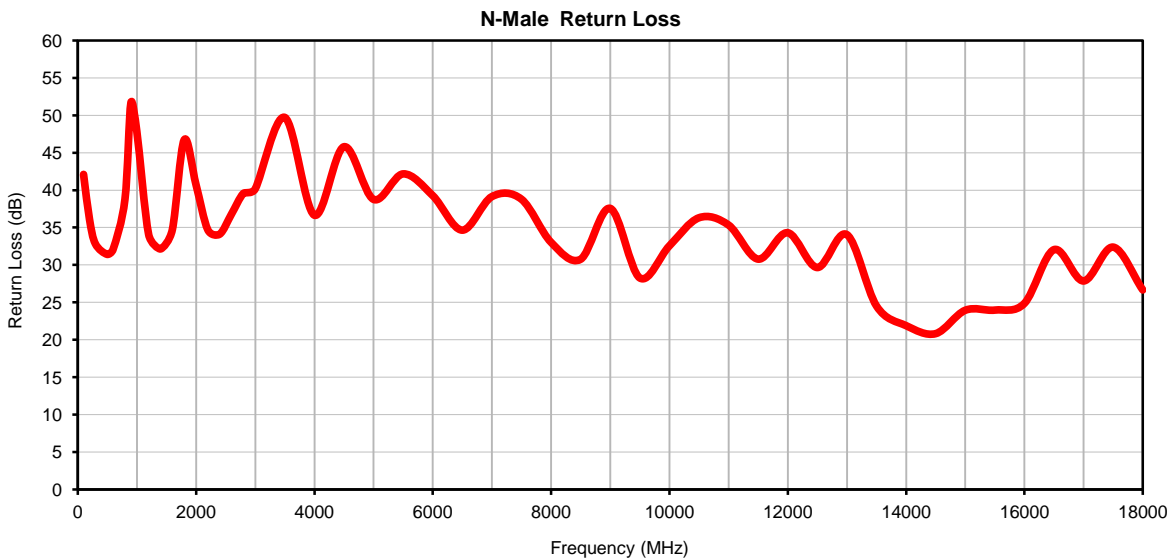
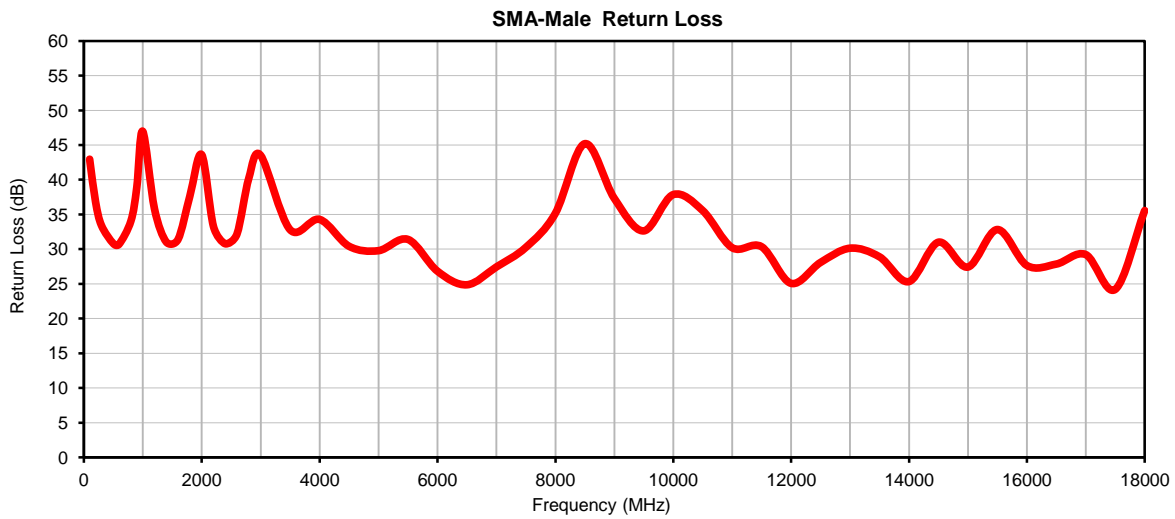

Outline Dimensions

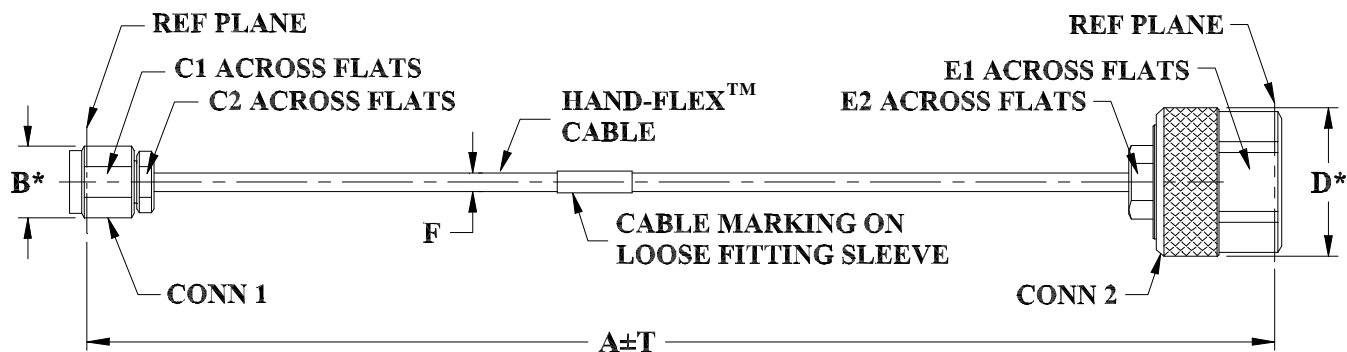

* OVERALL CONNECTOR DIMENSION
[CONNECTOR SHAPE MAY VARY]

KQ1668 SERIES
SMA MALE (CONN-1)
N MALE (CONN-2)

CASE STYLE #	A		B	C1	C2	D	E1	E2	F		T		WEIGHT GRAMS
	INCH	MM							141U-ASMNM+	141-ASMNM+	INCH	MM	
KQ1668-4	4.00	101.60	.36 (9.14)	.313 (7.95)	.250 (6.35)	.88 (22.35)	.750 (19.05)	.375 (9.53)	.141±.003 (3.58±0.07)	.163±.004 (4.14±0.10)	.05	1.27	37.87
KQ1668-5	5.00	127.00									.05	1.27	39.02
KQ1668-6	6.00	152.00									.05	1.27	40.16
KQ1668-7	7.00	177.80									.10	2.54	41.30
KQ1668-8	8.00	203.20									.10	2.54	42.44
KQ1668-10	10.00	254.00									.10	2.54	44.73
KQ1668-12	12.00	304.80									.10	2.54	47.02
KQ1668-18	18.00	457.20									.15	3.81	53.87
KQ1668-24	24.00	609.60									.15	3.81	60.73

Unless otherwise specified dimensions are in inches (mm).

Tolerances: 2Pl. $\pm .03$; 3Pl. $\pm .015$

Note:

1. 141 Hand-Flex™ Coaxial Cable.
2. "A" Represents Length of Cable.

Mini-Circuits®

Distribution Centers NORTH AMERICA 800-654-7949 • 417-335-5935 • Fax 417-335-5945 • EUROPE 44-1252-832600 • Fax 44-1252-837010

Mini-Circuits ISO 9001 & ISO 14001 Certified

INTERNET <http://www.minicircuits.com>

P.O. Box 350166, Brooklyn, New York 11235-0003 (718) 934-4500 Fax (718) 332-4661

All Mini-Circuits products are manufactured under exacting quality assurance and control standards, and are capable of meeting published specifications after being subjected to any or all of the following physical and environmental test.

Specification	Test/Inspection Condition	Reference/Spec
Operating Temperature	-55° to 105°C Ambient Environment	Individual Model Data Sheet
Storage Temperature	-55° to 105°C Ambient Environment	Individual Model Data Sheet
Thermal Shock	-55° to 100°C, 50 Cycles	MIL-STD-202F; Method 107G
Multiple Bend Radius	40 mm, 5 times for 141 series cables 30 mm, 5 times for 086 series cables	
Single Bend Radius	8 mm for 141 series cables 6 mm for 086 series cables	