



HAND FLEX™

Coaxial Cable

086-3SBSMR+

Mini-Circuits

50Ω 3 inch DC to 18 GHz Right Angle SMA-Male to SMA-Female Bulkhead

THE BIG DEAL

- Wideband frequency coverage, DC to 18 GHz
- Low Loss, 0.28 dB at 18 GHz
- Excellent Return Loss, 18 dB at 18 GHz
- SMA-F bulkhead connector at one end
- Hand formable to almost any custom shape without special bending tools
- 6mm bend radius for tight installations
- Anti-torque nut prevents cable stress during installation
- Insulated outer jacket standard
- Connector interface, meets MIL-STD-348
- Ideal for interconnect of assembled systems

APPLICATIONS

- Bulkhead connector mounts on front panel of equipment rack
- Replacement for custom bent 0.086" semi-rigid cables
- Communication receivers and transmitters
- Military and aerospace system
- Environmental and test chambers

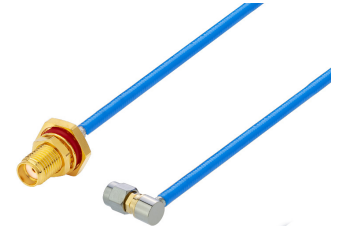

Generic photo used for illustration purposes only

Model No.	086-3SBSMR+
Case Style	KP1680-3
Connectors	Right Angle SMA-Male to SMA-Female Bulkhead

+RoHS Compliant

The +Suffix identifies RoHS Compliance. See our website for methodologies and qualifications

PRODUCT OVERVIEW

086-SBSMR+ Series Hand-Flex™ coaxial cables are ideal for interconnecting coaxial components and sub-assemblies in a wide range of systems, including communications, military and aerospace, environmental and test chamber systems and more. The hand-formable cable provides a minimum bend radius of 6mm to accommodate tight layouts without the need for bending tools, adapters or brackets. SMA right angle to SMA bulkhead connectors make these cables ideal for perpendicular connections run directly to the front panel of rack-mounted equipment. The connectors feature an anti-torque nut to prevent cable stress during installation and an insulated outer jacket to minimize signal leakage. They are available in a range of lengths to meet a variety of connection requirements.

KEY FEATURES

Feature	Advantages
Hand-Formable RF Cables	Facilitates the assembly of coaxial systems and sub-systems without the need for special cable-bending tools or adapters. Reduces the risk of damage during bending
Tight Bend Radius	6mm bend-radius makes the cable ideal for connections in tight spaces and crowded layouts
18 GHz Right-Angle SMA connector	Meets requirements of 90°connections without bending and without sacrificing high-frequency performance
18 GHz SMA Bulkhead connector	Ideal for making secure connections directly through equipment chassis panels
Excellent Return loss	Suitable for interconnecting a variety of RF components while minimizing VSWR ripple contribution
Good Power Handling Capability: <ul style="list-style-type: none"> • 211W at 0.5 GHz • 35W at 18 GHz 	Supports medium to high RF power levels used in transmit paths.
Anti-torque nut	Reduces risk of twist damage to cable during installation

Mini-Circuits



Coaxial Cable

086-3SBSMR+

50Ω 3 inch DC to 18 GHz Right Angle SMA-Male to SMA-Female Bulkhead

ELECTRICAL SPECIFICATIONS AT +25°C

Parameter	Frequency (GHz)	Min.	Typ.	Max.	Units
Frequency Range		DC		18	GHz
Length ¹		3			inches
Insertion Loss	DC - 2	—	0.11	0.30	dB
	2 - 6	—	0.18	0.52	
	6 - 10	—	0.25	0.68	
	10 - 18	—	0.36	0.93	
Return Loss	DC - 2	23	28	—	dB
	2 - 6	22	23	—	
	6 - 10	17	18	—	
	10 - 18	16	18	—	

1. Custom sizes available, consult factory.

ABSOLUTE MAXIMUM RATINGS

Parameter	Ratings
Operating Temperature	-55°C to +105°C
Storage Temperature	-55°C to +105°C
Power Handling at +25°C, Sea Level	211W at 0.5 GHz 150W at 1 GHz 104W at 2 GHz 59W at 6 GHz 45W at 10 GHz 35W at 18 GHz

Permanent damage may occur if any of these limits are exceeded.



HAND FLEX™

Coaxial Cable

086-3SBSMR+

Mini-Circuits

50Ω 3 inch DC to 18 GHz Right Angle SMA-Male to SMA-Female Bulkhead

CABLE CONSTRUCTION



- Center Conductor: Silver Plated Copper Clad Steel
- Dielectric: Solid PTFE
- Outer Shield: Copper Braid, Tin Soaked
- Jacket: FEP, Blue (Unjacketed cable also available upon request)

- Connectors:
- Coupling Nut: Stainless Steel Passivated
 - Body: Stainless Steel Gold Plated
 - Center Pin: Brass Gold Plated (SMA-M) and BeCub Gold Plated (SMA-F)

OUTLINE DRAWING

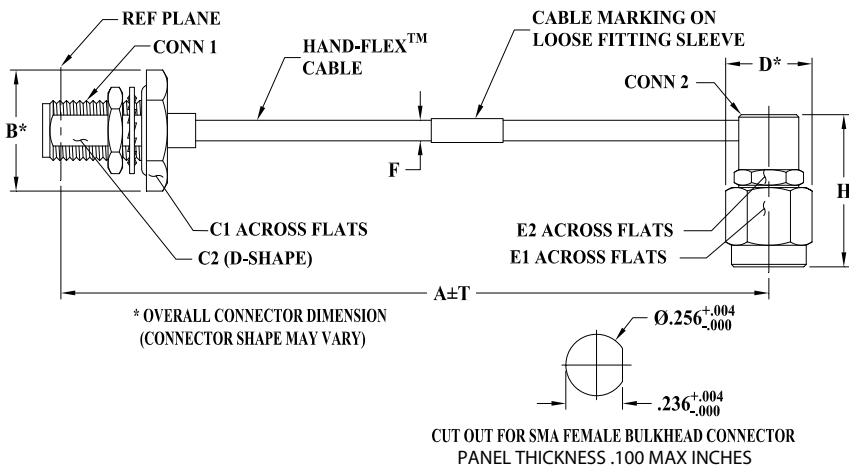

OUTLINE DIMENSIONS (Inch mm)

A	B	C1	C2	D	E1	E2	F	H	T	wt grams
3.0	.51	.438	.232	.36	.313	.250	.108	0.634	0.05	8.17
76.20	12.95	11.13	5.89	9.14	7.95	6.35	2.75	16.10	1.27	





HAND FLEX™

Coaxial Cable

086-3SBSMR+

Mini-Circuits

50Ω 3 inch DC to 18 GHz Right Angle SMA-Male to SMA-Female Bulkhead

TYPICAL PERFORMANCE DATA AND CHARTS

Frequency (MHz)	Insertion Loss (dB)	Return Loss (dB)	
		Right Angle SMA-Male	SMA-Female Bulkhead
100	0.02	46.8	48.7
1000	0.07	35.3	35.7
1800	0.10	32.6	31.3
2404	0.11	27.3	28.9
4001	0.14	28.2	31.1
5000	0.15	28.7	29.4
6000	0.16	29.3	28.6
7001	0.16	29.9	29.5
8001	0.17	31.0	30.7
9000	0.21	20.8	20.9
10000	0.20	25.4	25.7
12001	0.21	27.7	27.3
14001	0.23	30.0	29.5
17069	0.30	21.8	22.0
18000	0.28	37.3	39.9

086-3SBSMR+
INSERTION LOSS

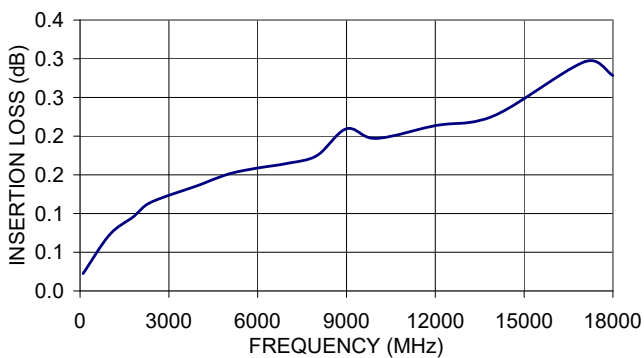

086-3SBSMR+
RETURN LOSS

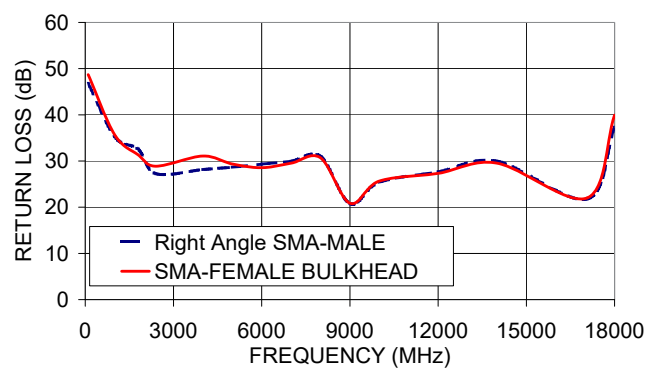

Hand-Flex Coaxial Cable, Right Angle SMA-M/SMA-F Bulkhead 086-3SBSMR+

Typical Performance Data

FREQUENCY (MHz)	INSERTION LOSS (dB)	RIGHT ANGLE SMA-MALE RETURN LOSS (dB)	SMA-FEMALE BULKHEAD RETURN LOSS (dB)
100.0	0.02	46.8	48.7
200.0	0.03	42.8	42.0
300.0	0.04	42.8	39.9
400.0	0.05	42.9	37.5
500.0	0.05	41.4	36.1
600.0	0.06	39.7	35.0
700.0	0.07	38.1	34.4
800.0	0.07	36.8	34.4
900.0	0.07	36.2	34.9
1000.0	0.07	35.3	35.7
1100.0	0.07	35.1	36.5
1250.0	0.08	34.8	37.6
1500.0	0.09	35.3	36.2
1750.0	0.10	33.0	31.7
2000.0	0.10	30.0	29.5
2250.0	0.11	28.0	28.8
2500.0	0.12	27.5	29.6
2750.0	0.12	28.7	31.4
3000.0	0.12	31.0	32.6
3250.0	0.12	30.2	30.3
3500.0	0.13	27.8	28.5
3750.0	0.14	27.1	28.7
4000.0	0.14	28.1	31.1
4250.0	0.14	30.8	33.7
4500.0	0.14	32.3	33.1
5000.0	0.15	28.5	29.1
6000.0	0.16	29.3	28.6
6500.0	0.16	29.7	29.5
7000.0	0.17	30.1	29.5
7500.0	0.19	23.1	23.2
8000.0	0.18	29.8	29.6
8500.0	0.19	24.5	24.6
9000.0	0.21	20.7	20.9
9500.0	0.18	28.9	28.4
10000.0	0.20	25.4	25.7
10500.0	0.22	22.6	22.8
11000.0	0.20	30.6	29.8
11500.0	0.20	30.9	31.7
12000.0	0.21	27.4	26.7
12500.0	0.21	31.6	30.2
13000.0	0.21	35.5	36.4
13500.0	0.23	26.5	26.3
14000.0	0.23	29.9	29.7
14500.0	0.24	26.5	27.2
15000.0	0.25	25.2	25.5
15500.0	0.25	31.1	31.8
16000.0	0.27	23.8	24.2
16500.0	0.26	30.7	31.4
17000.0	0.29	23.6	23.9
17500.0	0.31	20.3	20.4
18000.0	0.28	37.3	39.9



P.O. Box 350166, Brooklyn, New York 11235-0003 (718) 934-4500 • Fax (718) 332-4661 For detailed performance specs & shopping online see Mini-Circuits web site



The Design Engineers Search Engine Provides ACTUAL Data Instantly From MINI-CIRCUITS At: www.minicircuits.com

IF/RF MICROWAVE COMPONENTS

REV. OR

086-3SBSMR+

4/9/2014

Page 1 of 1

Hand-Flex Coaxial Cable, Right Angle SMA-M/SMA-F Bulkhead 086-3SBSMR+

Typical Performance Data

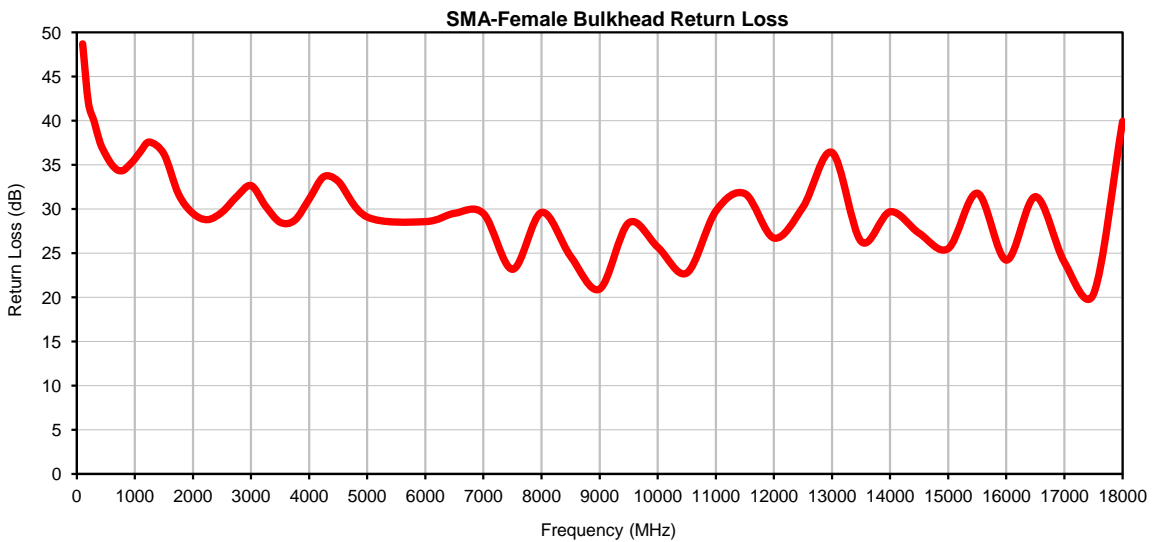
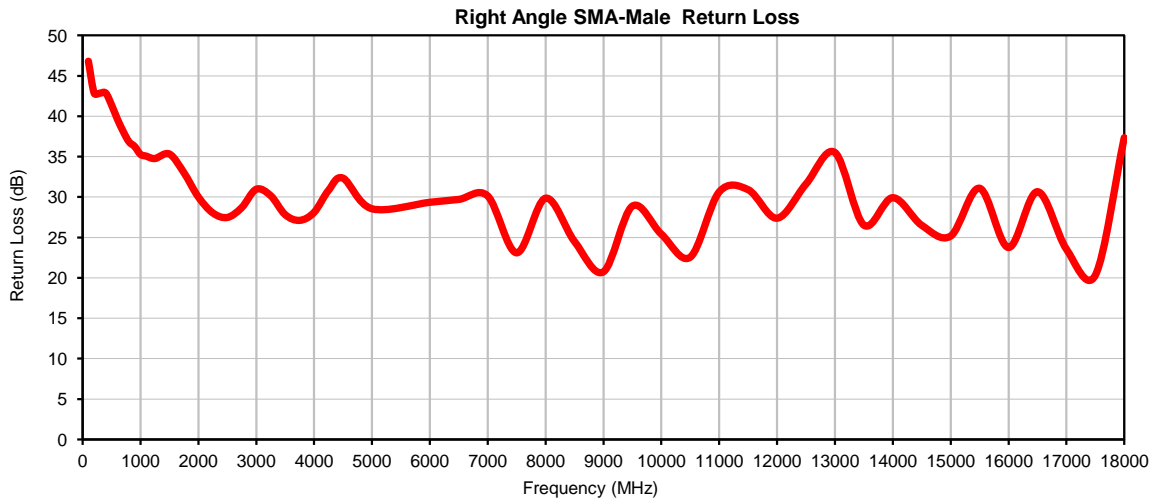
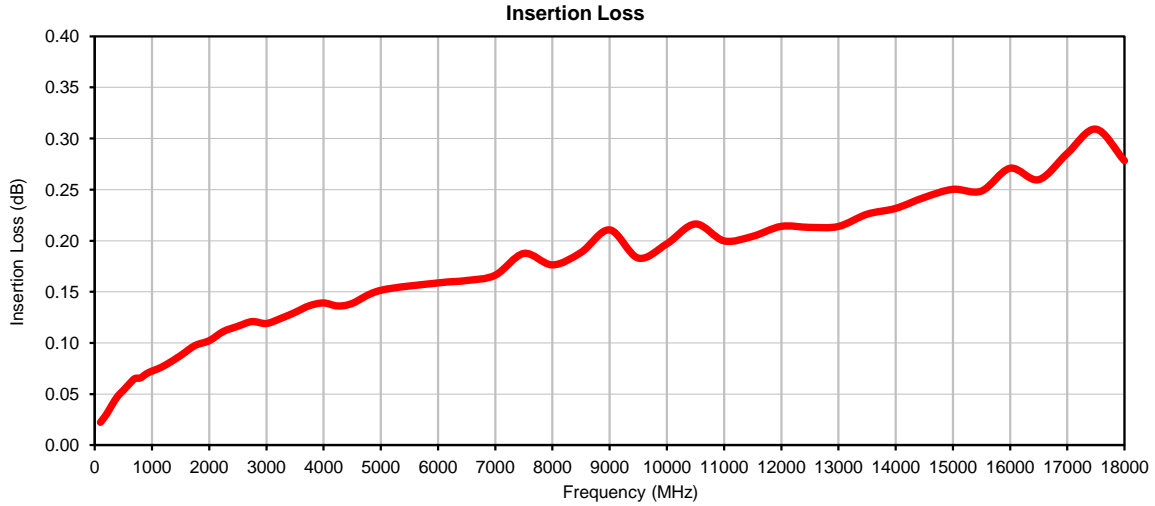

Outline Dimensions

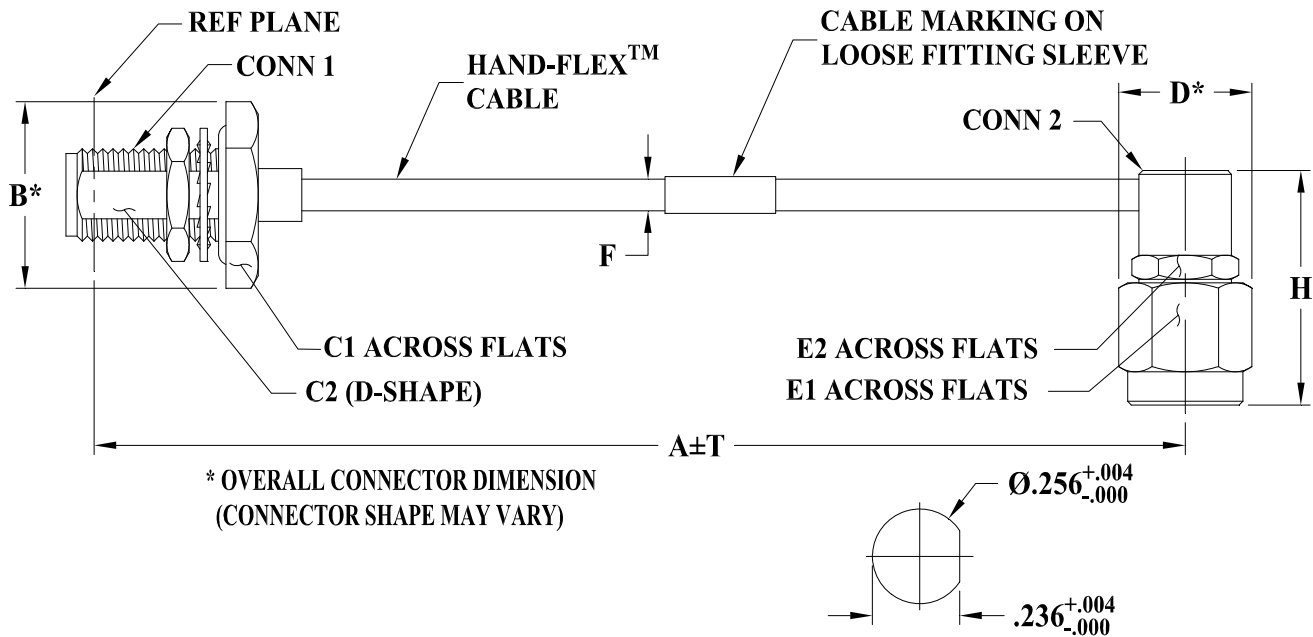

* OVERALL CONNECTOR DIMENSION
(CONNECTOR SHAPE MAY VARY)

CUT OUT FOR SMA FEMALE BULKHEAD CONNECTOR
PANEL THICKNESS .100 MAX INCHES

KP1680 SERIES
BULKHEAD SMA FEMALE (CONN-1)
RIGHT ANGLE SMA MALE (CONN-2)

CASE STYLE #	A		B	C1	C2	D	E1	E2	F		G	H	T		WEIGHT GRAMS
	INCH	MM							086U-ASMRSM+	086-ASMRSM+			INCH	MM	
KP1680-2	2.00	50.80	.51 (12.95)	.438 (11.13)	.232 (5.89)	.36 (9.14)	.313 (7.95)	.250 (6.35)	.089 ∇ .002 (2.26 ∇ .05)	.108 NOM (2.74 NOM)	-	.634 (16.10)	.05	1.27	7.71
KP1680-3	3.00	76.20											.05	1.27	8.17
KP1680-4	4.00	101.60											.05	1.27	8.63
KP1680-5	5.00	127.00											.05	1.27	9.09
KP1680-6	6.00	152.40											.05	1.27	9.54
KP1680-8	8.00	203.20											.10	2.54	10.46
KP1680-18	18.00	457.20	.15	3.81	15.03										

Unless otherwise specified dimensions are in inches (mm).

Tolerances: 2Pl. $\pm .03$; 3Pl. $\pm .015$

Note:

- 086 Hand-Flex™ Coaxial Cable.
- "A" represents length of cable.



INTERNET <http://www.minicircuits.com>
P.O. Box 350166, Brooklyn, New York 11235-0003 (718) 934-4500 Fax (718) 332-4661
Distribution Centers NORTH AMERICA 800-654-7949 • 417-335-5935 • Fax 417-335-5945 • EUROPE 44-1252-832600 • Fax 44-1252-837010
Mini-Circuits ISO 9001 & ISO 14001 Certified



All Mini-Circuits products are manufactured under exacting quality assurance and control standards, and are capable of meeting published specifications after being subjected to any or all of the following physical and environmental test.

Specification	Test/Inspection Condition	Reference/Spec
Operating Temperature	-55° to 105° C or -55° to 85° C (see datasheet) Ambient Environment	Individual Model Data sheet
Storage Temperature	-55° to 105° C or -55° to 85° C (see data sheet) Ambient Environment	Individual Model Data Sheet
Thermal Shock	-55° to 100°C, 100 Cycles	MIL-STD-202F; Method 107G
Multiple Bend Radius	40 mm, 5 times for 141 series cables 30 mm, 5 times for 086 series cables	
Single Bend Radius	8 mm for 141 series cables 6 mm for 086 series cables	