



Coaxial Cable

086-36SM+

Mini-Circuits

50Ω 36 inch DC to 18 GHz SMA Male

THE BIG DEAL

- Wideband frequency coverage, DC to 18 GHz
- Low Loss, 3.3 dB at 18 GHz
- Excellent Return Loss, 19 dB at 18 GHz
- Hand Formable to almost any custom shape without special bending tools
- 6mm bend radius for tight installations
- Anti-torque nut prevents cable stress during installation
- Connector interface, meets MIL-STD-348
- Ideal for interconnect of assembled systems



Generic photo used for illustration purposes only

Model No.	086-36SM+
Case Style	KP1505-36
Connectors	SMA Male

+RoHS Compliant

The +Suffix identifies RoHS Compliance. See our website for methodologies and qualifications

APPLICATIONS

- Replacement for custom bent 0.086" semi-rigid cables
- Communication Receivers and Transmitters
- Military and Aerospace System
- Environmental and Test Chambers

PRODUCT OVERVIEW

The 086-SM+ Series Hand-Flex™ Coaxial Cables are ideal for interconnection of coaxial components or sub-systems. The construction includes a silver-plated copper-clad steel center conductor which maintains the shape after bending. The outer shield is copper braid, tin soaked, which minimizes signal leakage and at the same time flexible for easy bend. Dielectric is low loss PTFE. Connectors have passivated stainless-steel coupling nut over a gold plated connector body and gold plated, brass center conductor. The 086-SM+ Series Hand-Flex™ cables are available in variety of length to meet your requirements.

KEY FEATURES

Feature	Advantages
Hand-Flex™ (Hand-formable RF cables)	The 086 Series Hand-Flex cables are hand formable making them ideal for use integrating coaxial components and sub-assemblies without the need for special cable-bending tools and alleviating the risk of damage during the bending process typical of semi-rigid coaxial cable assemblies.
Tight bend radius	Capable of only 6mm bend radius, the 086 Hand Flex series is able to make connections in tight spaces making these cables ideal for dense system integration
Excellent Return Loss	Minimizes signal reflection and VSWR ripple contribution.
Good power handling capability: 211W at 0.5 GHz 35W at 18 GHz	Mini-Circuits 086 Cable series can support medium to high RF power levels enabling these cables to be used in the transmit path. NOTE: power rating is at sea-level altitudes.
Built-in Anti-torque nut	Mini-Circuits 086 Series Hand Flex cables include an anti-torque feature to support the connector body during installation alleviating risk of stress to the connector/cable interface
Jacketed and Unjacketed options	Standard 086 Series cables include a blue FEP insulator jacket reducing the risk of accidental shorting of DC power lines or active pins during installation and operation. Un-jacketed versions are available upon request



**ELECTRICAL SPECIFICATIONS AT 25°C**

Parameter	Frequency (GHz)	Min.	Typ.	Max.	Units
Frequency Range		DC	-	18	GHz
Length ¹		36			inches
Insertion Loss	DC - 2	-	0.62	1.10	dB
	2 - 6	-	1.11	1.97	
	6 - 10	-	1.79	2.67	
	10 - 18	-	2.44	3.72	
Return Loss	DC - 2	23	41	-	dB
	2 - 6	23	42	-	
	6 - 10	17	35	-	
	10 - 18	16	29	-	

1. Custom sizes available, consult factory.

ABSOLUTE MAXIMUM RATINGS

Parameter	Ratings
Operating Temperature	-55°C to +85°C
Storage Temperature	-55°C to +85°C
Power Handling at 25°C, Sea Level	211W at 0.5 GHz 150W at 1 GHz 104W at 2 GHz 59W at 6 GHz 45W at 10 GHz 35W at 18 GHz

Permanent damage may occur if any of these limits are exceeded.



HAND FLEX™

Coaxial Cable

086-36SM+

Mini-Circuits

50Ω 36 inch DC to 18 GHz SMA Male

CABLE CONSTRUCTION

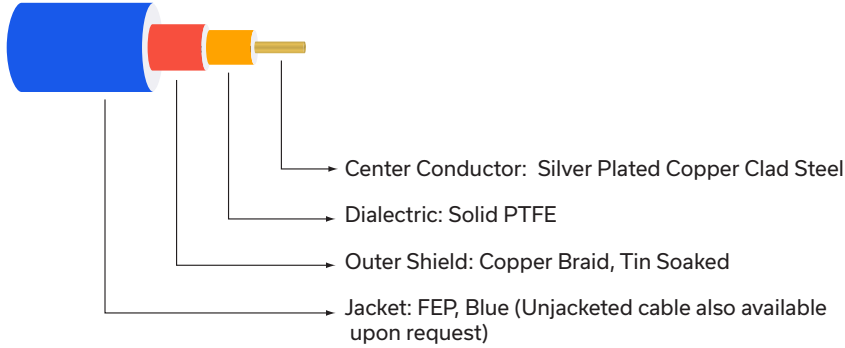

Connectors: Coupling Nut: Stainless Steel Passivated
 Body: Stainless Steel Gold Plated
 Center Pin: Brass, Gold Plated

OUTLINE DRAWING

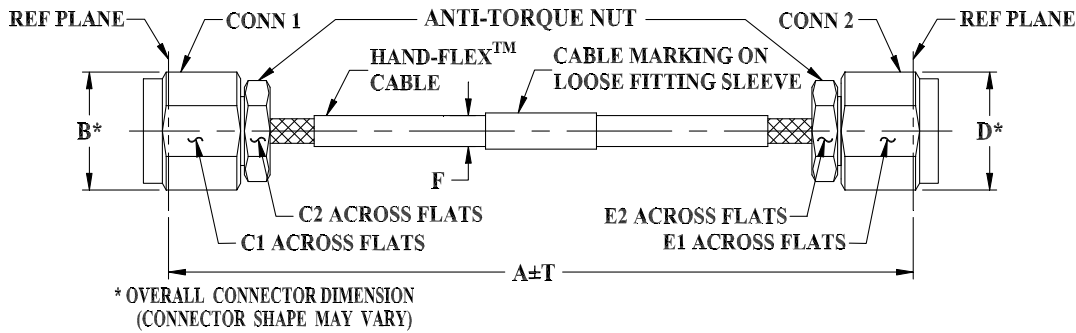

OUTLINE DIMENSIONS (Inch/mm)

A	B	C1	C2	D	E1	E2	F	T	wt
2.0	.36	.315	.250	.36	.315	.250	.123 MAX.	.05	grams
50.80	9.14	8.00	6.35	9.14	8.00	6.35	2.31 MAX	1.27	6.11

Mini-Circuits



HAND FLEX™

Coaxial Cable

086-36SM+

Mini-Circuits

50Ω 36 inch DC to 18 GHz SMA Male

TYPICAL PERFORMANCE DATA AND CHARTS

Frequency (MHz)	Insertion Loss (dB)	Return Loss (dB)	
		SMA-Male	SMA-Male
100	0.22	46.4	44.8
1000	0.67	39.8	39.2
1800	0.90	39.4	37.8
2404	1.04	37.7	36.9
4001	1.36	36.5	38.0
5000	1.52	35.4	38.8
6000	1.69	35.1	39.7
7001	1.84	33.8	36.8
8001	1.98	31.8	33.7
9000	2.12	29.8	30.5
10000	2.26	26.9	27.7
12001	2.39	23.8	25.4
14001	2.71	24.9	26.5
17069	3.18	24.2	26.7
18000	3.33	19.3	20.8

086-36SM+
INSERTION LOSS

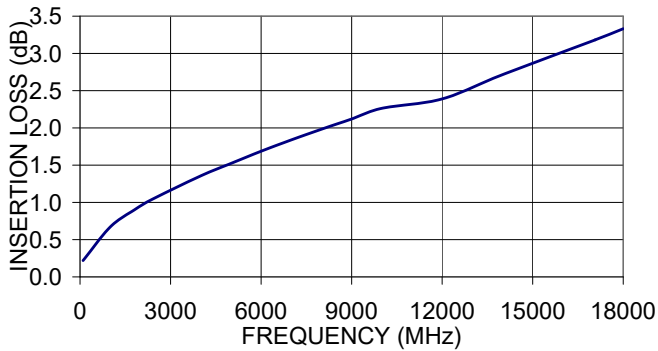

086-36SM+
RETURN LOSS

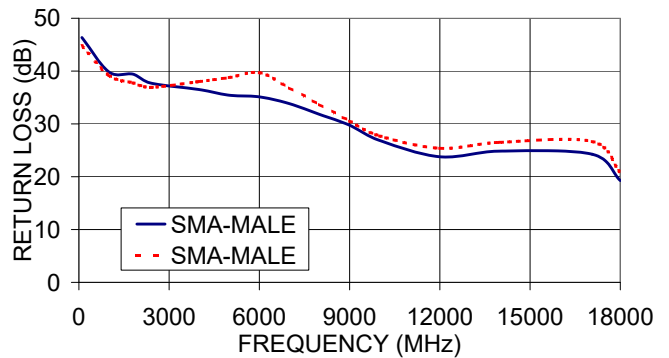



PROPER CABLE CONNECTION USING ANTI-TORQUE NUT

Mini-Circuits 086-series HandFlex™ interconnect cables are constructed with an anti-torque nut adjacent to the connector coupling nut. When used properly, this feature prevents possible damage to the cable due to torquing and twisting when tightening the cable connector.

TO PROPERLY TIGHTEN THE CABLE CONNECTOR:

1) The cable connector includes a coupling nut which rotates to fasten the connector, and an anti-torque nut, which is fixed to prevent the cable from twisting during connection.

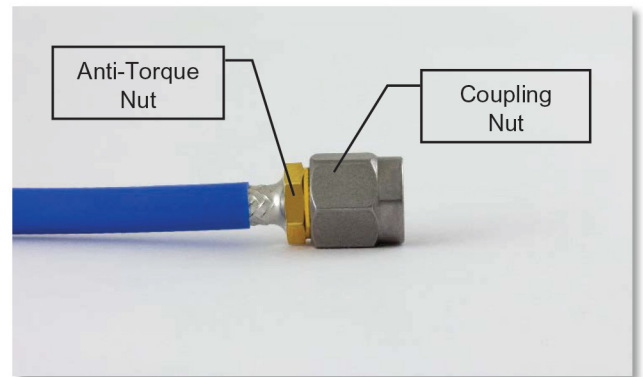

2) To properly tighten the cable, use a standard 1/4-inch open end wrench to brace the anti-torque nut.



3) Using a 5/16-inch open end wrench, rotate the coupling nut clockwise to tighten the cable connector.

*NOTE: Mini-Circuits recommends using a 5/16-inch open end wrench calibrated to 8 inch-pounds maximum torque to prevent damage due to over-torquing the connector.

NOTES

- A. Performance and quality attributes and conditions not expressly stated in this specification document are intended to be excluded and do not form a part of this specification document.
- B. Electrical specifications and performance data contained in this specification document are based on Mini-Circuit's applicable established test performance criteria and measurement instructions.
- C. The parts covered by this specification document are subject to Mini-Circuits standard limited warranty and terms and conditions (collectively, "Standard Terms"); Purchasers of this part are entitled to the rights and benefits contained therein. For a full statement of the standard terms and the exclusive rights and remedies thereunder, please visit Mini-Circuits' website at www.minicircuits.com/terms/viewterm.html

Typical Performance Data

FREQUENCY (MHz)	INSERTION LOSS (dB)	SMA-MALE 1 RETURN LOSS (dB)	SMA-MALE 2 RETURN LOSS (dB)
100.0	0.22	46.4	44.8
200.0	0.30	45.1	43.8
300.0	0.37	43.8	43.2
400.0	0.42	42.4	41.9
500.0	0.47	42.0	41.0
600.0	0.52	41.5	40.7
700.0	0.56	41.1	40.3
800.0	0.60	40.5	39.9
900.0	0.64	40.4	39.6
1000.0	0.67	39.8	39.2
1100.0	0.70	39.9	39.0
1250.0	0.75	39.9	38.7
1500.0	0.82	39.9	38.5
1750.0	0.89	39.5	37.9
2000.0	0.95	39.3	37.6
2001.0	0.95	37.9	36.9
2250.0	1.00	37.8	37.0
2500.0	1.06	37.6	37.0
2750.0	1.11	37.6	37.2
3000.0	1.16	37.5	37.2
3250.0	1.22	37.3	37.4
3500.0	1.26	37.0	37.6
3750.0	1.31	36.8	37.8
4000.0	1.35	36.5	38.0
4250.0	1.41	36.2	38.2
4500.0	1.45	36.0	38.4
5000.0	1.52	35.4	38.8
5500.0	1.60	35.2	39.2
6000.0	1.69	35.1	39.7
6500.0	1.76	34.2	37.8
7000.0	1.84	33.8	36.9
7500.0	1.91	32.8	35.3
8000.0	1.98	31.8	33.7
8500.0	2.05	30.8	32.1
9000.0	2.12	29.8	30.6
9500.0	2.18	28.2	29.2
10000.0	2.26	26.9	27.7
10500.0	2.29	23.5	24.9
11000.0	2.29	23.6	25.0
11500.0	2.33	23.7	25.2
12000.0	2.40	23.8	25.4
12500.0	2.44	24.0	25.6
13000.0	2.53	24.2	25.8
13500.0	2.68	24.5	26.1
14000.0	2.75	24.8	26.5
14500.0	2.80	24.6	26.4
15000.0	2.90	24.5	26.4
15500.0	2.95	24.5	26.5
16000.0	3.00	24.7	26.5
16500.0	3.13	24.4	26.4
17000.0	3.16	24.3	26.6
17500.0	3.19	24.7	27.0
18000.0	3.33	19.3	20.8

Typical Performance Curves

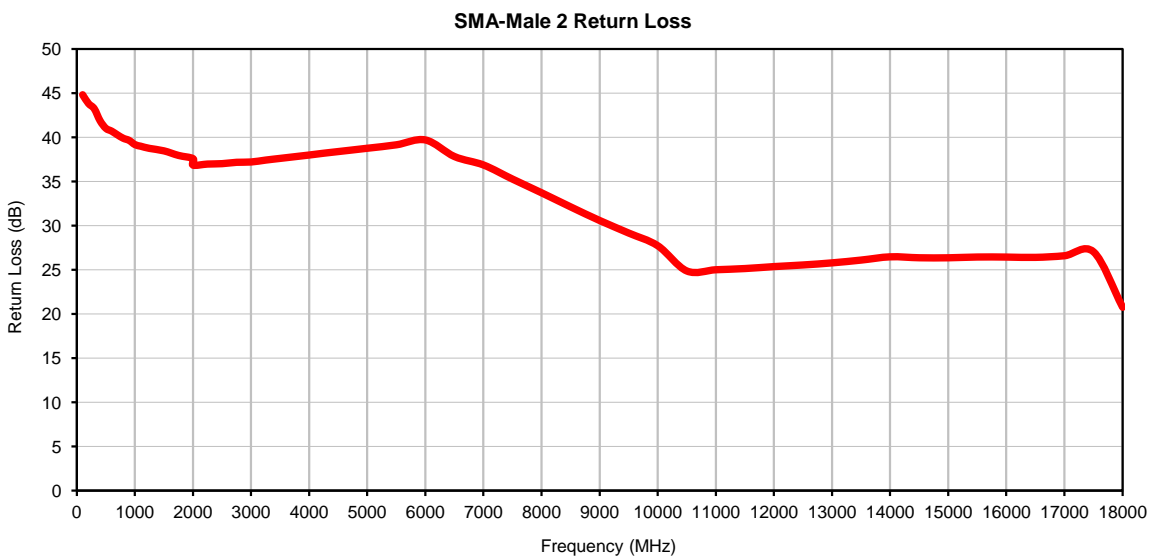
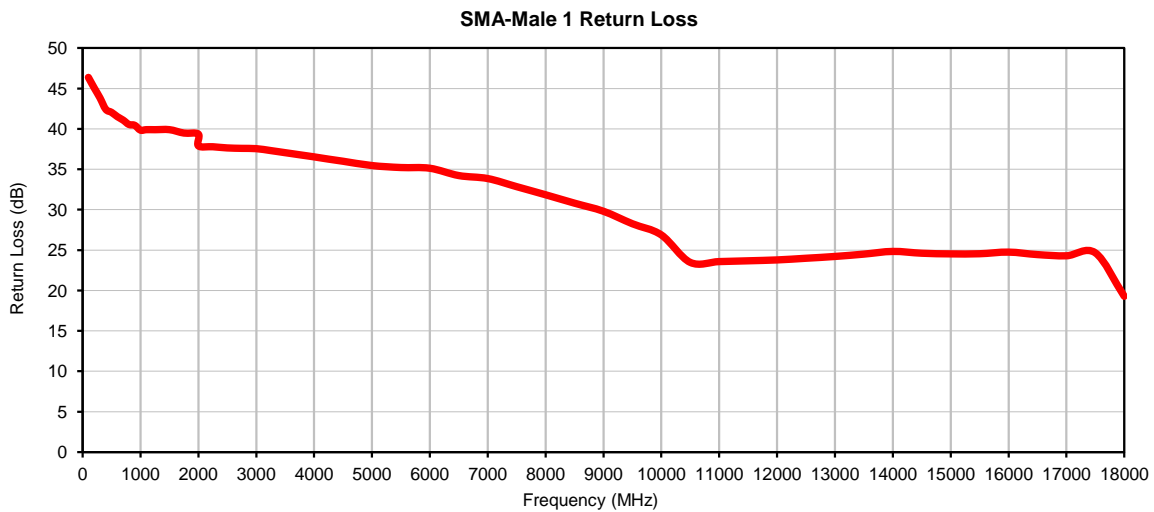

Outline Dimensions

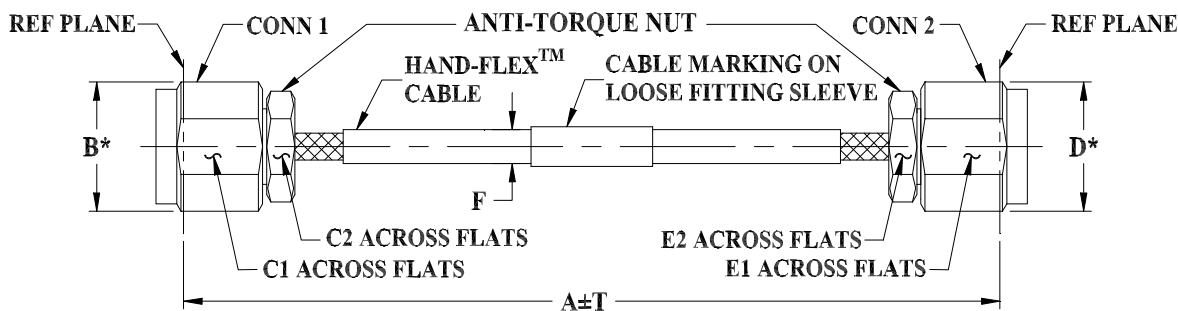

* OVERALL CONNECTOR DIMENSION
(CONNECTOR SHAPE MAY VARY)

KP1505 SERIES
SMA MALE (CONN-1)
SMA MALE (CONN-2)

CASE STYLE #	A		B	C1	C2	D	E1	E2	F		T		WEIGHT GRAMS
	INCH	MM							086U-ASM+	086-ASM+	INCH	MM	
KP1505-2	2.00	50.80	.36 (9.14)	.315 (8.00)	.250 (6.35)	.36 (9.14)	.315 (8.00)	.250 (6.35)	.091 MAX (2.31 MAX)	.123 MAX (3.12 MAX)	.05	1.27	6.11
KP1505-3	3.00	76.20									.05	1.27	6.57
KP1505-4	4.00	101.60									.05	1.27	7.03
KP1505-5	5.00	127.00									.05	1.27	7.49
KP1505-6	6.00	152.40									.05	1.27	7.94
KP1505-7	7.00	177.80									.10	2.54	8.40
KP1505-8	8.00	203.20									.10	2.54	8.86
KP1505-9	9.00	228.60									.10	2.54	9.31
KP1505-9.5	9.50	241.30									.10	2.54	9.54
KP1505-10	10.00	254.00									.10	2.54	9.77
KP1505-11	11.00	279.40									.10	2.54	10.23
KP1505-11.5	11.50	292.10									.10	2.54	10.46
KP1505-12	12.00	304.80									.10	2.54	10.68
KP1505-12.5	12.50	317.50									.15	3.81	10.91
KP1505-13	13.00	330.20									.15	3.81	11.14
KP1505-14	14.00	355.60									.15	3.81	11.60
KP1505-15	15.00	381.00	.15	3.81	12.06								
KP1505-15.5	15.50	393.70	.15	3.81	12.28								
KP1505-16	16.00	406.40	.15	3.81	12.51								

Unless otherwise specified dimensions are in inches (mm).

Tolerances: 2Pl. ± .03; 3Pl. ± .015

Note:

1. 086 Hand-Flex™ Coaxial Cable.
2. "A" Represents Length of Cable.



Distribution Centers NORTH AMERICA 800-654-7949 • 417-335-5935 • Fax 417-335-5945 • EUROPE 44-1252-832600 • Fax 44-1252-837010

Mini-Circuits ISO 9001 & ISO 14001 Certified

INTERNET <http://www.minicircuits.com>

P.O. Box 350166, Brooklyn, New York 11235-0003 (718) 934-4500 Fax (718) 332-4661

CASE STYLE #	A		B	C1	C2	D	E1	E2	F		T		WEIGHT GRAMS
	INCH	MM							086U-ASM+	086-ASM+	INCH	MM	
KP1505-18	18.00	457.20	.36 (9.14)	.315 (8.00)	.250 (6.35)	.36 (9.14)	.315 (8.00)	.250 (6.35)	.091 MAX (2.31 MAX)	.123 MAX (3.12 MAX)	.15	3.81	13.43
KP1505-20	20.00	508.00									.15	3.81	14.34
KP1505-22	22.00	558.80									.15	3.81	15.24
KP1505-24	24.00	609.60									.15	3.81	16.17
KP1505-26	26.00	660.40									.20	5.08	17.08
KP1505-27	27.00	685.80									.20	5.08	17.54
KP1505-30	30.00	762.00									.20	5.08	18.91
KP1505-36	36.00	914.40									.20	5.08	21.65
KP1505-48	48.00	1219.20									.30	7.62	27.14



All Mini-Circuits products are manufactured under exacting quality assurance and control standards, and are capable of meeting published specifications after being subjected to any or all of the following physical and environmental test.

Specification	Test/Inspection Condition	Reference/Spec
Operating Temperature	-55° to 105° C or -55° to 85° C (see datasheet) Ambient Environment	Individual Model Data sheet
Storage Temperature	-55° to 105° C or -55° to 85° C (see data sheet) Ambient Environment	Individual Model Data Sheet
Thermal Shock	-55° to 100°C, 100 Cycles	MIL-STD-202F; Method 107G
Multiple Bend Radius	40 mm, 5 times for 141 series cables 30 mm, 5 times for 086 series cables	
Single Bend Radius	8 mm for 141 series cables 6 mm for 086 series cables	