

**THE BIG DEAL**

- Wideband frequency coverage, DC to 3 GHz
- Low Loss, 0.4 dB at 3 GHz
- Excellent Return Loss, 27 dB at 3 GHz
- Hand formable to almost any custom shape without special bending tools
- 6mm bend radius for tight installations
- Insulated outer jacket standard¹
- Connector interface, meets MIL-STD-348
- Ideal for interconnect of assembled systems



Generic photo used for illustration purposes only

Model No.	086-12BM+
Case Style	KP2467-12
Connectors	BNC-Male

+RoHS Compliant

The +Suffix identifies RoHS Compliance.
See our website for methodologies and qualifications

APPLICATIONS

- Replacement for custom bent 0.086" semi-rigid cables
- Communication Receivers and Transmitters
- Military and Aerospace System
- Environmental and Test Chambers

PRODUCT OVERVIEW

The 086-BM+ Series Hand-Flex™ Coaxial Cables are ideal for interconnecting coaxial components and sub-assemblies in a wide range of systems, including communications, military and aerospace, environmental test chambers and more. The hand-formable cable provides a minimum bend radius of 6mm to accommodate tight layouts without the need for bending tools, adapters or brackets. BNC-male connectors make these cables ideal for connection of assemblies with BNC connector types. 086-BM+ series cables are available in a variety of lengths to meet your system needs.

KEY FEATURES

Feature	Advantages
Hand-Flex™ (Hand-formable RF cables)	Facilitates the assembly of coaxial systems and sub-systems without the need for special cable bending tools or adapters. Reduces the risk of damage during bending.
Tight bend-radius, 6mm	6mm bend-radius makes the cable ideal for connections in tight spaces and crowded layouts.
Low Insertion Loss	Minimizes overall signal path loss.
Excellent Return Loss	Minimizes signal reflection and VSWR ripple contribution
BNC-Male Connectors	Supports easy interconnection of components and equipment in systems with BNC connector types.
Good Power Handling Capability: • 211W at 0.5 GHz • 80W at 3 GHz	Supports medium to high RF power levels used in transmit paths. For higher power handling, refer to our 141-XXBM+ series cables.

1. Unjacketed cable also available upon request.

REV. A
ECO-017558
086-12BM+
MCL NY
240105



Coaxial Cable

ELECTRICAL SPECIFICATIONS AT 25°C

Parameter	Frequency (GHz)	Min.	Typ.	Max.	Units
Frequency Range		DC		3	GHz
Length ²		12			inches
Insertion Loss	DC - 3	—	0.27	0.7	dB
Return Loss	DC - 3	19	36	—	dB

2. Custom sizes available, consult factory.

ABSOLUTE MAXIMUM RATINGS

Parameter	Ratings
Operating Temperature	-55°C to +105°C
Storage Temperature	-55°C to +105°C
Power Handling at 25°C, Sea Level	211W at 0.5 GHz 150W at 1 GHz 101W at 2 GHz 80W at 3 GHz

Permanent damage may occur if any of these limits are exceeded.



HAND FLEX™

Coaxial Cable

086-12BM+

Mini-Circuits

50Ω 12 inch DC to 3 GHz BNC-Male

CABLE CONSTRUCTION

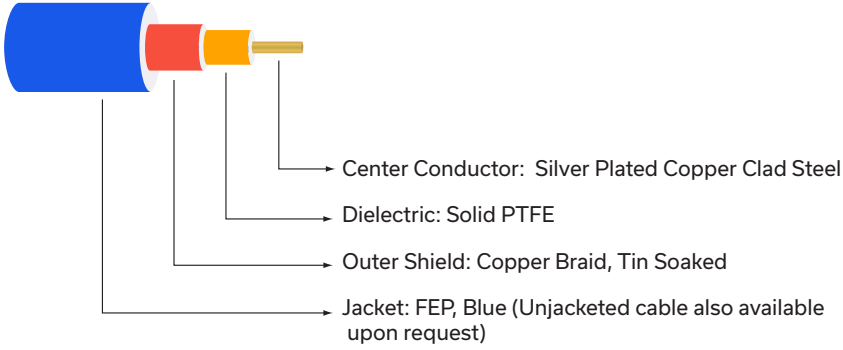

Connectors: Body & Coupling Nut: Brass, Nickel Plated
Center Pin: Brass, Gold Plated

OUTLINE DRAWING

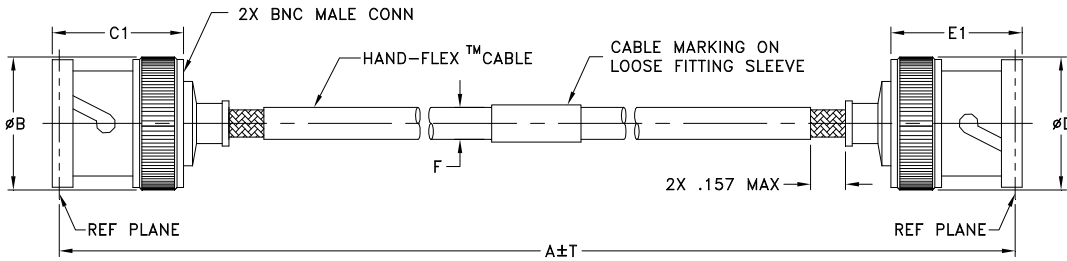

OUTLINE DIMENSIONS (Inch/mm)

A	B	C1	C2	D	E1	E2	F	T	wt
12.0	.57	.59	--	.57	.59	--	.108	0.10	grams
304.80	14.5	14.99	--	14.5	14.99	--	2.75	2.54	25.88





HAND FLEX™

Coaxial Cable

086-12BM+

Mini-Circuits

50Ω 12 inch DC to 3 GHz BNC-Male

TYPICAL PERFORMANCE DATA AND CHARTS

Frequency (MHz)	Insertion Loss (dB)	Return Loss (dB)	
		BNC-Male	BNC-Male
10	0.02	47.7	51.8
250	0.11	46.7	49.7
400	0.14	40.1	41.3
620	0.18	42.4	37.9
850	0.21	39.8	41.0
1000	0.23	38.9	34.6
1220	0.25	36.2	36.9
1450	0.27	34.3	32.1
1600	0.28	38.3	36.7
1820	0.30	33.1	30.2
2050	0.33	38.7	31.6
2200	0.33	31.1	27.9
2420	0.36	34.9	31.8
2800	0.38	38.2	32.5
3000	0.39	27.8	26.4

086-12BM+
INSERTION LOSS

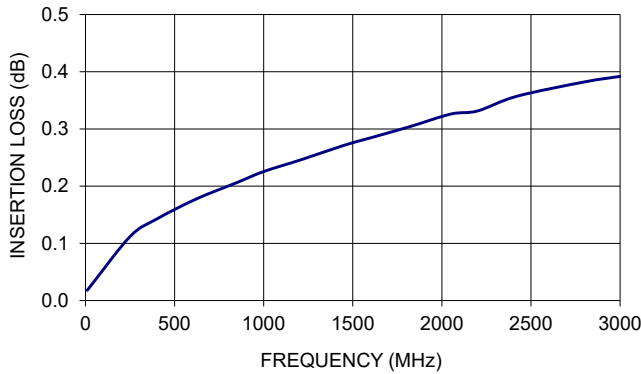

086-12BM+
RETURN LOSS

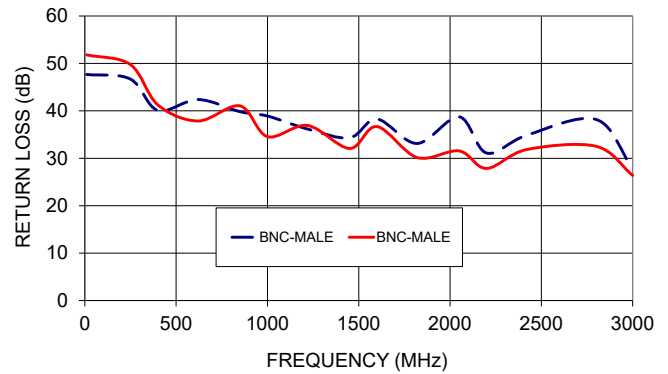

NOTES

- A. Performance and quality attributes and conditions not expressly stated in this specification document are intended to be excluded and do not form a part of this specification document.
- B. Electrical specifications and performance data contained in this specification document are based on Mini-Circuit's applicable established test performance criteria and measurement instructions.
- C. The parts covered by this specification document are subject to Mini-Circuits standard limited warranty and terms and conditions (collectively, "Standard Terms"); Purchasers of this part are entitled to the rights and benefits contained therein. For a full statement of the standard terms and the exclusive rights and remedies thereunder, please visit Mini-Circuits' website at www.minicircuits.com/terms/viewterm.html



Typical Performance Data

FREQUENCY (MHz)	INSERTION LOSS (dB)	BNC-MALE 1 RETURN LOSS (dB)	BNC-MALE 2 RETURN LOSS (dB)
10	0.02	47.7	51.8
20	0.03	45.1	48.7
30	0.04	43.4	46.6
40	0.04	42.1	45.5
50	0.05	41.6	43.4
60	0.05	41.0	43.8
70	0.06	40.7	43.5
80	0.06	40.5	43.1
90	0.07	40.3	43.2
100	0.07	40.2	43.1
150	0.09	41.7	45.2
170	0.09	43.0	47.6
250	0.11	46.7	49.7
320	0.13	43.0	43.2
400	0.14	40.1	41.3
470	0.15	42.6	45.4
550	0.17	58.3	43.6
620	0.18	42.4	37.9
700	0.19	37.1	35.8
770	0.20	36.4	37.1
850	0.21	39.8	41.0
920	0.22	49.0	38.8
1000	0.23	38.9	34.6
1070	0.23	34.5	33.5
1150	0.24	33.7	35.0
1220	0.25	36.2	36.9
1300	0.25	47.6	35.2
1370	0.26	40.3	32.8
1450	0.27	34.3	32.1
1520	0.28	33.9	33.7
1600	0.28	38.3	36.7
1670	0.29	52.1	33.8
1750	0.30	36.2	30.4
1820	0.30	33.1	30.2
1900	0.31	34.5	33.9
1970	0.32	41.5	40.2
2050	0.33	38.7	31.6
2120	0.33	32.8	28.0
2200	0.33	31.1	27.9
2270	0.34	32.5	31.3
2350	0.35	36.3	48.1
2420	0.36	34.9	31.8
2500	0.36	30.9	26.9
2570	0.36	29.6	26.3
2650	0.37	30.6	29.2
2720	0.38	34.3	37.5
2800	0.38	38.2	32.5
2900	0.38	30.4	26.1
3000	0.39	27.8	26.4



P.O. Box 350166, Brooklyn, New York 11235-0003 (718) 934-4500 • Fax (718) 332-4661 For detailed performance specs & shopping online see Mini-Circuits web site



The Design Engineers Search Engine Provides ACTUAL Data Instantly From MINI-CIRCUITS At: www.minicircuits.com

IF/RF MICROWAVE COMPONENTS

Typical Performance Curves

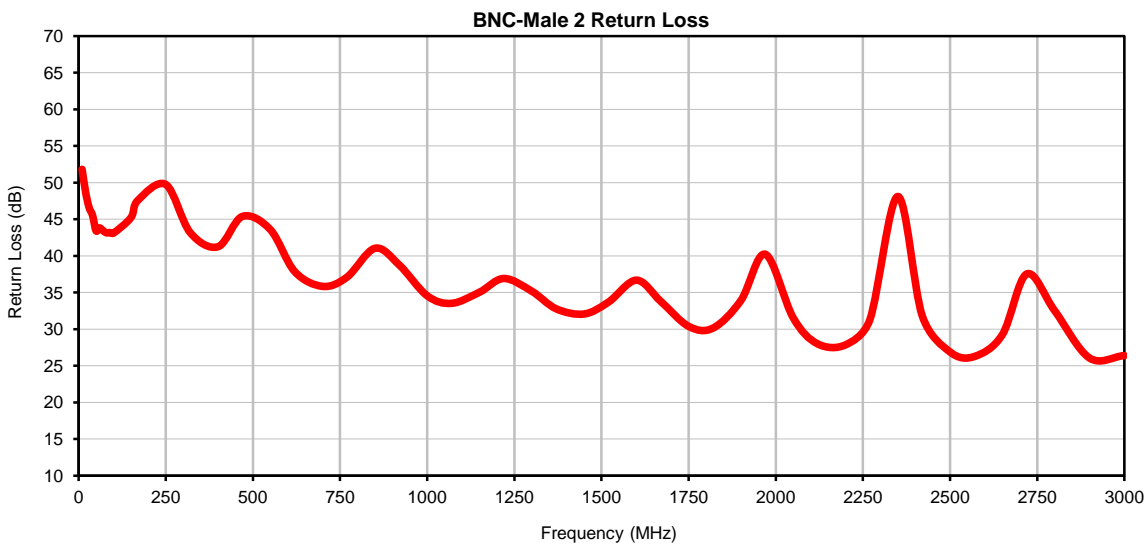
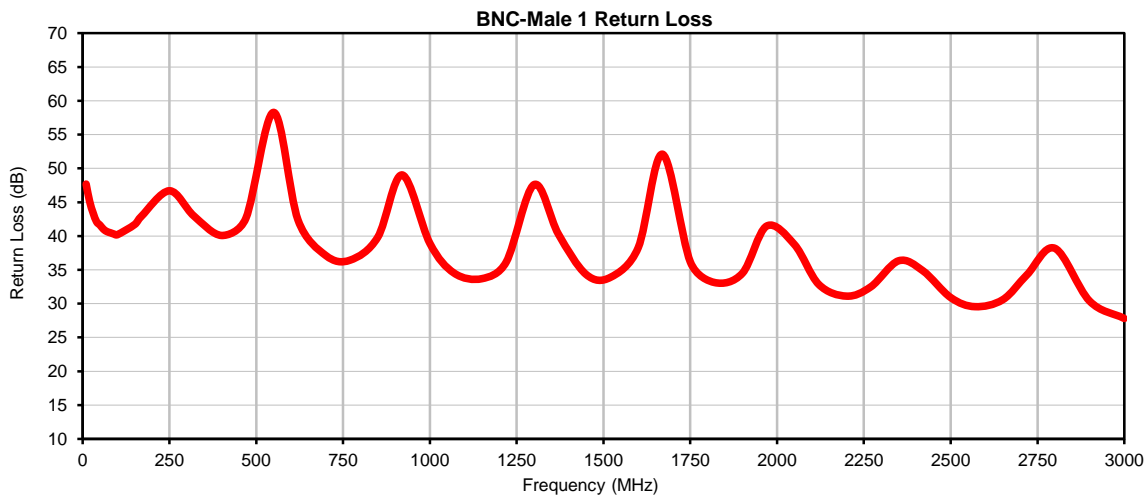
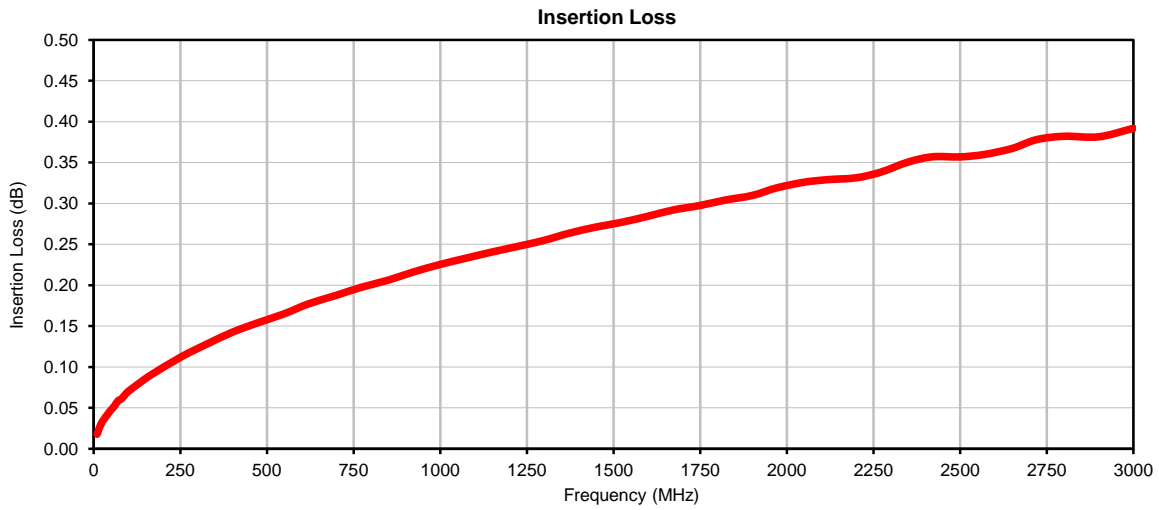

Outline Dimensions

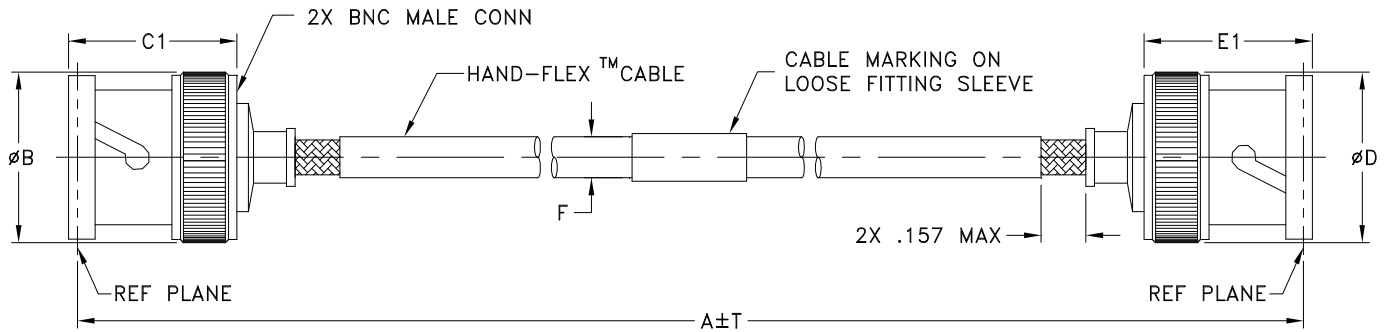

KP2467 SERIES
BNC MALE (CONN-1)
BNC MALE (CONN-2)

CASE STYLE #	A		B	C1	C2	D	E1	E2	F		T		WEIGHT GRAMS
	INCH	MM							086U-ABM+	086-ABM+	INCH	MM	
KP2467-6	6.00	152.40	.57 (14.5)	.59 (14.9)	-	.57 (14.5)	.59 (14.9)	-	.089±.002 (2.26±0.05)	.108 NOM (2.72 NOM)	.05	1.27	23.14
KP2467-8	8.00	203.20									.10	2.54	24.06
KP2467-10	10.00	254.00									.10	2.54	24.97
KP2467-12	12.00	304.80									.10	2.54	25.88
KP2467-18	18.00	457.20									.15	3.81	28.63
KP2467-24	24.00	609.60									.15	3.81	31.37

Unless otherwise specified dimensions are in inches (mm).

Tolerances: 2Pl. ± .03; 3Pl. ± .015

Note:

1. 141 Hand-Flex™ Coaxial Cable.
2. "A" represents length of cable.



INTERNET <http://www.minicircuits.com>

P.O. Box 350166, Brooklyn, New York 11235-0003 (718) 934-4500 Fax (718) 332-4661

Distribution Centers NORTH AMERICA 800-654-7949 • 417-335-5935 • Fax 417-335-5945 • EUROPE 44-1252-832600 • Fax 44-1252-837010

Mini-Circuits ISO 9001 & ISO 14001 Certified



All Mini-Circuits products are manufactured under exacting quality assurance and control standards, and are capable of meeting published specifications after being subjected to any or all of the following physical and environmental test.

Specification	Test/Inspection Condition	Reference/Spec
Operating Temperature	-55° to 105° C or -55° to 85° C (see datasheet) Ambient Environment	Individual Model Data sheet
Storage Temperature	-55° to 105° C or -55° to 85° C (see data sheet) Ambient Environment	Individual Model Data Sheet
Thermal Shock	-55° to 100°C, 100 Cycles	MIL-STD-202F; Method 107G
Multiple Bend Radius	40 mm, 5 times for 141 series cables 30 mm, 5 times for 086 series cables	
Single Bend Radius	8 mm for 141 series cables 6 mm for 086 series cables	