

**THE BIG DEAL**

- Wideband frequency coverage, DC to 18 GHz
- Low Loss, 1.73 dB at 18 GHz
- Excellent Return Loss, 24 dB at 18 GHz
- Hand formable to almost any custom shape without special bending tools
- 3.2mm bend radius for tight installations
- Connector interface, meets MIL-STD-348
- Ideal for interconnect of assembled systems

*Generic photo used for illustration purposes only*

Model No.	047-12SMPR+
Case Style	BZ2421H12
Connectors	Right Angle SMP-Female

+RoHS Compliant

The +Suffix identifies RoHS Compliance.
See our website for methodologies and qualifications

APPLICATIONS

- Replacement for custom bent 0.047" semi-rigid cables
- Communication receivers and transmitters
- Military and aerospace system
- Environmental and test chambers

PRODUCT OVERVIEW

The 047 Series Hand-Flex™ Coaxial Cables are ideal for interconnection of coaxial components or sub-systems in tight spaces. The outer shield is tin plated copper braid and tin soaked, which minimizes signal leakage and at the same time flexible for easy bend. Right-angle SMP-F blind mate push-on / snap-on connectors make these cables ideal for connections between adjacent modules in crowded system layouts. The 047 Series Hand-Flex™ Cables features gold plated beryllium copper construction. The 047 Series Cables are available in variety of length to meet your requirements.

KEY FEATURES

Feature	Advantages
Hand-Formable RF Cables	The 047 Series Hand-Flex™ cables are hand formable making them ideal for use integrating coaxial components and sub-assemblies without the need for special cable-bending tools and alleviating the risk of damage during the bending process typical of semi-rigid coaxial cable assemblies.
Tight Bend Radius, 3.2mm	Capable of only 3.2mm bend radius, the 047 Hand-Flex™ series is able to make connections in tight spaces making these cables ideal for dense system integration.
Right-angle SMP-F blind mate push-on / snap-on connectors	Ideal for interconnect of adjacent modules with tight space constraints without sacrificing high- frequency performance due to severe bend near the connector interface.
Excellent Return loss, • 30 dB at 6 GHz • 24 dB at 18 GHz	The 047 Series Hand-Flex™ Cables are ideally suited for interconnecting a wide variety of RF components while minimizing VSWR ripple contribution due to mating cables & connectors.
Good Power Handling Capability: • 22.5 W at 0.5 GHz • 4.5 W at 18 GHz	Mini-Circuits' 047 Cable series can support medium to high RF power levels enabling these cables to be used in the transmit path.



ELECTRICAL SPECIFICATIONS AT +25°C

Parameter	Frequency (GHz)	Min.	Typ.	Max.	Units
Frequency Range		DC		18	GHz
Length ¹		12			inches
Insertion Loss	DC - 2	—	0.41	0.80	dB
	2 - 6	—	0.73	1.53	
	6 - 10	—	1.14	1.91	
	10 - 18	—	1.53	2.62	
Return Loss	DC - 2	20	31	—	dB
	2 - 6	20	31	—	
	6 - 10	17	32	—	
	10 - 18	17	28	—	

1. Custom sizes available, consult factory.

ABSOLUTE MAXIMUM RATINGS

Parameter	Ratings
Operating Temperature	-45°C to 85°C
Storage Temperature	-45°C to 85°C
Power Handling at +25°C, Sea Level	22.5 W at 0.5 GHz 15.5W at 1 GHz 11W at 2 GHz 5.5W at 6 GHz 4.6W at 10 GHz 4.5 W at 18 GHz

Permanent damage may occur if any of these limits are exceeded.



HAND FLEX™

Coaxial Cable

047-12SMPR+

Mini-Circuits

50Ω 12 inch DC to 18 GHz Right Angle SMP-Female

CABLE CONSTRUCTION

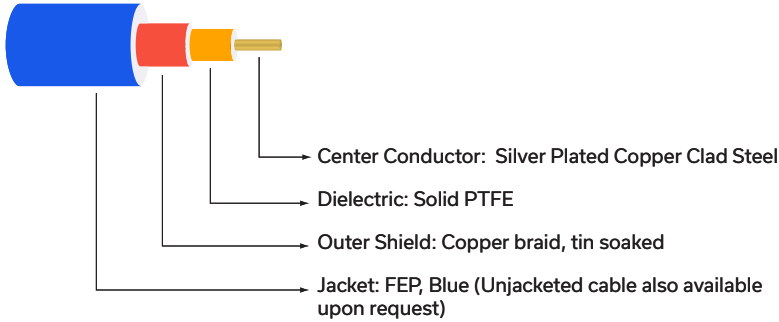

Connectors: Coupling Nut: Stainless Steel Passivated
 Body: Stainless Steel Gold Plated
 Center Pin: Brass Gold Plated

OUTLINE DRAWING

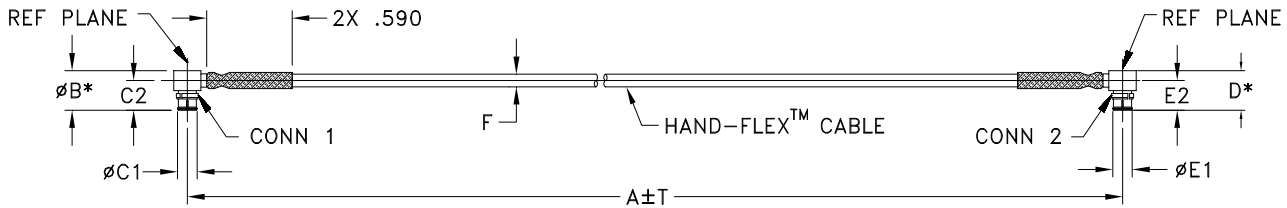

* OVERALL CONNECTOR DIMENSION [CONNECTOR SHAPE MAY VARY]

OUTLINE DIMENSIONS (Inch/mm)

A	B	C1	C2	D	E1
12.0	.14	.135	.287	.14	.135
304.80	3.56	3.43	7.29	3.56	3.43
E2	F	T	wt		
.289	.069	0.1	grams		
7.34	1.75	2.54	4.00		





HAND FLEX™

Coaxial Cable

047-12SMPR+

Mini-Circuits

50Ω 12 inch DC to 18 GHz Right Angle SMP-Female

TYPICAL PERFORMANCE DATA AND CHARTS

Frequency (MHz)	Insertion Loss (dB)	Return Loss (dB)	
		Right Angle SMP-Female	Right Angle SMP-Female
100	0.12	32.3	31.7
1000	0.40	47.9	52.0
2000	0.58	33.5	34.3
2500	0.65	32.5	33.0
4000	0.83	31.5	35.8
5000	0.92	38.1	40.8
6000	1.02	34.7	30.8
7000	1.09	30.9	28.6
8000	1.17	36.8	34.9
9000	1.22	39.6	32.3
10000	1.34	31.7	28.7
12000	1.44	25.0	36.2
14000	1.48	35.7	27.8
17000	1.78	30.1	28.3

047-12SMPR+ INSERTION LOSS

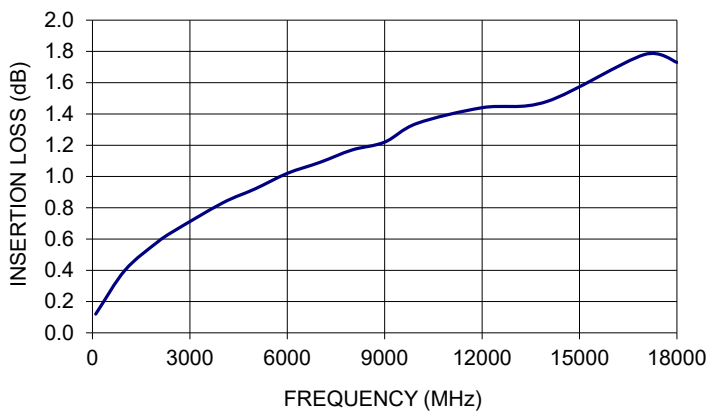

047-12SMPR+ RETURN LOSS

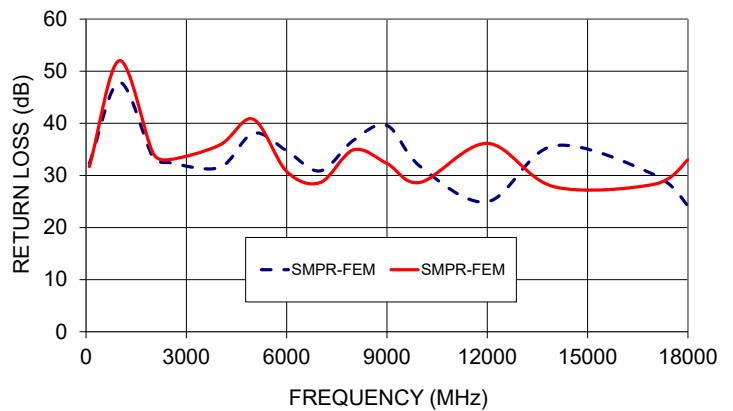

NOTES

- A. Performance and quality attributes and conditions not expressly stated in this specification document are intended to be excluded and do not form a part of this specification document.
- B. Electrical specifications and performance data contained in this specification document are based on Mini-Circuit's applicable established test performance criteria and measurement instructions.
- C. The parts covered by this specification document are subject to Mini-Circuits standard limited warranty and terms and conditions (collectively, "Standard Terms"); Purchasers of this part are entitled to the rights and benefits contained therein. For a full statement of the standard terms and the exclusive rights and remedies thereunder, please visit Mini-Circuits' website at www.minicircuits.com/terms/viewterm.html



Typical Performance Data

FREQUENCY (MHz)	INSERTION LOSS (dB)	RIGHT ANGLE SMP-FEMALE 1 RETURN LOSS (dB)	RIGHT ANGLE SMP-FEMALE 2 RETURN LOSS (dB)
100	0.12	32.3	31.7
200	0.17	30.6	29.9
300	0.21	40.0	38.9
400	0.24	33.9	33.6
500	0.28	29.3	28.9
600	0.30	33.7	33.3
700	0.33	39.4	39.3
800	0.35	29.2	29.1
900	0.38	30.1	30.1
1000	0.40	47.9	52.0
1100	0.42	30.4	30.1
1200	0.45	27.8	27.8
1300	0.46	33.7	34.4
1400	0.47	36.0	35.3
1500	0.50	27.9	28.0
1600	0.52	29.0	29.4
1800	0.55	30.6	30.4
2000	0.58	33.5	34.3
2500	0.65	33.6	33.5
3000	0.72	31.3	31.7
3500	0.75	32.1	29.1
4000	0.82	31.9	37.7
4500	0.88	31.8	27.6
5000	0.92	36.7	36.0
5500	1.00	28.7	26.1
6000	1.02	34.7	30.8
6500	1.06	39.2	38.5
7000	1.10	30.9	28.7
7500	1.13	36.9	31.1
8000	1.17	38.6	36.0
8500	1.19	30.3	28.4
9000	1.21	38.7	31.1
9500	1.31	26.3	30.1
10000	1.34	31.7	28.7
10500	1.36	36.7	31.5
11000	1.41	25.9	30.4
11500	1.50	30.9	30.0
12000	1.45	25.4	39.4
12500	1.54	29.6	26.7
13000	1.40	28.2	28.1
13500	1.63	22.7	23.7
14000	1.67	39.8	27.0
14500	1.73	26.7	22.4
15000	1.70	29.7	30.0
15500	1.75	27.9	23.6
16000	1.71	37.4	27.5
16500	1.78	25.0	21.2
17000	1.80	26.0	24.1
17500	1.84	25.2	22.0
18000	1.73	24.2	33.0

Hand-Flex Coaxial Cable

047-12SMPR+

Right Angle SMP-Female to Right Angle SMP-Female

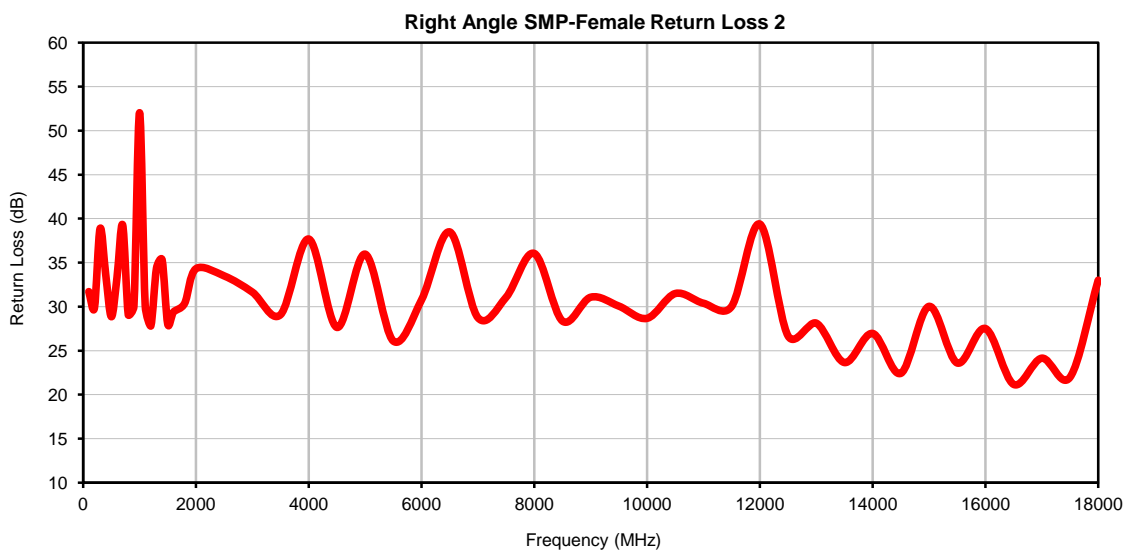
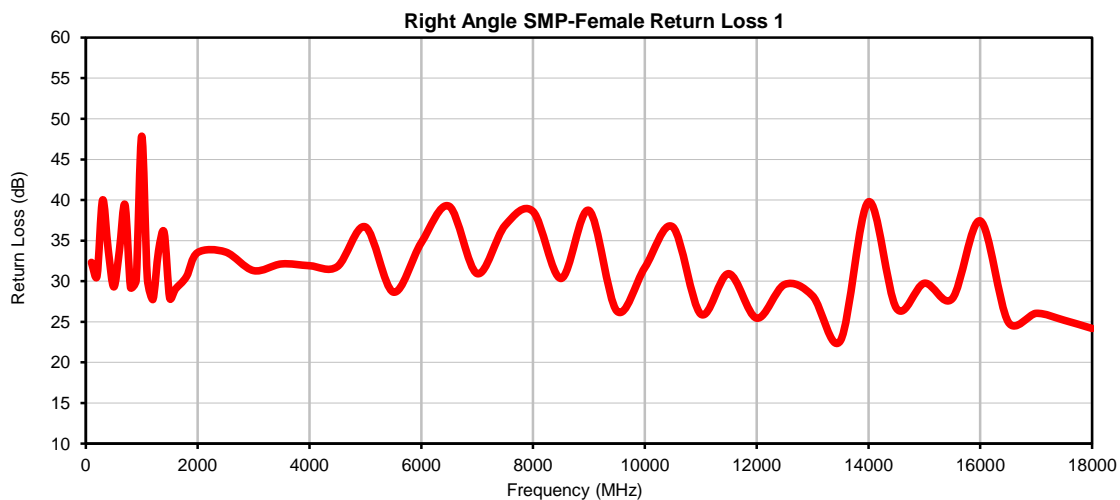

P.O. Box 350166, Brooklyn, New York 11235-0003 (718) 934-4500 • Fax (718) 332-4661 For detailed performance specs & shopping online see Mini-Circuits web site
The Design Engineers Search Engine Provides ACTUAL Data Instantly From MINI-CIRCUITS At: www.minicircuits.com



IF/RF MICROWAVE COMPONENTS

REV. OR
047-12SMPR+
3/20/2018
Page 1 of 1

Outline Dimensions

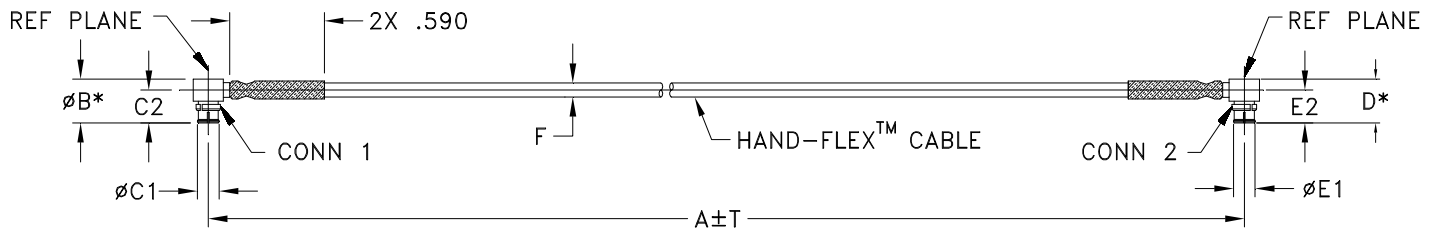

* OVERALL CONNECTOR DIMENSION [CONNECTOR SHAPE MAY VARY]

BZ2421H SERIES
 SMPR FEMALE (CONN-1)
 SMPR FEMALE (CONN-2)

CASE STYLE #	A		B	C1	C2	D	E1	E2	F		G	H	T		WEIGHT GRAMS
	INCH	MM							047U-ASMPR+	047-ASMPR+			INCH	MM	
BZ2421H3	3.00	76.20	.14 (3.50)	.135 (3.43)	.287 (7.35)	.14 (3.50)	.135 (3.43)	.289 (7.35)	.048 MAX (1.22 MAX)	.069 MAX (1.75 MAX)	--	--	.05	1.27	1.4
BZ2421H6	6.00	152.40									--	--	.05	1.27	2.2
BZ2421H12	12.00	304.80									--	--	.10	2.54	4.0

Unless otherwise specified dimensions are in inches (mm).

Tolerances: 2Pl. ± .03; 3Pl. ± .015

Note:

- 047 Hand-Flex™ Coaxial Cable.
- "A" represents length of cable.



INTERNET <http://www.minicircuits.com>

P.O. Box 350166, Brooklyn, New York 11235-0003 (718) 934-4500 Fax (718) 332-4661

Distribution Centers NORTH AMERICA 800-654-7949 • 417-335-5935 • Fax 417-335-5945 • EUROPE 44-1252-832600 • Fax 44-1252-837010

Mini-Circuits ISO 9001 & ISO 14001 Certified



All Mini-Circuits products are manufactured under exacting quality assurance and control standards, and are capable of meeting published specifications after being subjected to any or all of the following physical and environmental test.

Specification	Test/Inspection Condition	Reference/Spec
Operating Temperature	-45° to 85°C Ambient Environment	Individual Model Data Sheet
Storage Temperature	-45° to 85°C Ambient Environment	Individual Model Data Sheet
Thermal Shock	-45° to 125°C, 3 Cycles	MIL-STD-202F; Method 107G
Single Bend Radius	3.2 mm for 047 series cables	