

# Voltage Controlled Oscillator

## ROS-2360W+

Wide Band 1430 to 2360 MHz



CASE STYLE: CK605

### Features

- wide band frequency range
- low phase noise
- low pushing
- aqueous washable

### Applications

- wireless communications
- signal analyzer

**+RoHS Compliant**

The +Suffix identifies RoHS Compliance. See our web site for RoHS Compliance methodologies and qualifications

### Electrical Specifications

MODEL NO.	FREQ. (MHz)		POWER OUTPUT (dBm)	PHASE NOISE dBc/Hz SSB at offset frequencies, kHz				TUNING					NON HARMONIC SPURIOUS (dBc)	HARMONICS (dBc)		PULLING pk-pk @ 12 dB Br (MHz)	PUSHING (MHz/V)	DC OPERATING POWER				
	Min.	Max.		Typ.	1	10	100	1000	VOLTAGE RANGE (V)		SENSI- PORT TIVITY CAP (pF)	3 dB MODULATION BANDWIDTH (MHz)		Typ.	Typ.			Max.	Typ.	Typ.	Vcc (volts)	Current (mA)
	Min.	Max.							Min.	Max.												
ROS-2360W+	1430	2360	+8.5	-73	-100	-122	-142	0.5	20	51-70	65	95	-90	-20	-10	7	0.5	5	35			

### Pin Connections

RF OUT	10
VCC	14
V-TUNE	2
GROUND	1,3,4,5,6,7,8,9,11,12,13,15,16

### Maximum Ratings

Operating Temperature	-55°C to 85°C
Storage Temperature	-55°C to 100°C
Absolute Max. Supply Voltage (Vcc)	7V
Absolute Max. Tuning Voltage (Vtune)	22V
All specifications	50 ohm system

Permanent damage may occur if any of these limits are exceeded.

### Tape & Reel: F37

7" Reels with 10, 20, 50, 100 devices  
13" Reels with 200, 500 devices

### Environmental Ratings: ENV65

### Outline Drawing

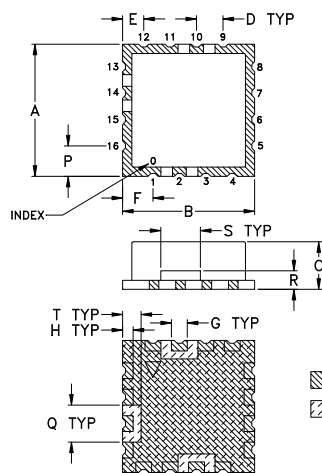

### PCB Land Pattern

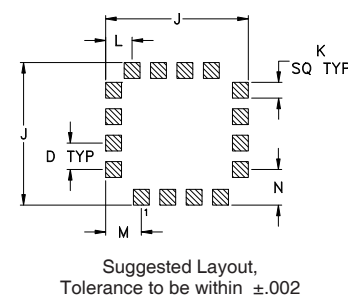

**Demo Board MCL P/N: TB-10**  
**Suggested PCB Layout (PL-012)**

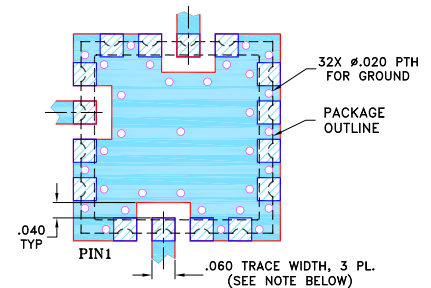

#### NOTES:

1. TRACE WIDTH IS SHOWN FOR FR4 WITH DIELECTRIC THICKNESS .030" ± .002"; COPPER: 1/2 OZ. EACH SIDE. FOR OTHER MATERIALS TRACE WIDTH MAY NEED TO BE MODIFIED.
  2. BOTTOM SIDE OF THE BOTTOM IS CONTINUOUS GROUND PLANE.
- 

### Outline Dimensions (inch/mm)

A	B	C	D	E	F	G	H	J	K	L	M	N	P	Q	R	S	T	wt.
.500	.500	.180	.100	.080	.115	.060	.040	.540	.060	.100	.135	.135	.115	.140	.070	.150	.070	grams
12.70	12.70	4.57	2.54	2.03	2.92	1.52	1.02	13.72	1.52	2.54	3.43	3.43	2.92	3.56	1.78	3.81	1.78	1.0

#### Notes

- A. Performance and quality attributes and conditions not expressly stated in this specification document are intended to be excluded and do not form a part of this specification document.  
 B. Electrical specifications and performance data contained in this specification document are based on Mini-Circuit's applicable established test performance criteria and measurement instructions.  
 C. The parts covered by this specification document are subject to Mini-Circuits standard limited warranty and terms and conditions (collectively, "Standard Terms"); Purchasers of this part are entitled to the rights and benefits contained therein. For a full statement of the Standard Terms and the exclusive rights and remedies thereunder, please visit Mini-Circuits' website at [www.minicircuits.com/MCLStore/terms.jsp](http://www.minicircuits.com/MCLStore/terms.jsp)



# Performance Data & Curves\*

# ROS-2360W+

V TUNE	TUNE SENS (MHz/V)	FREQUENCY (MHz)			POWER OUTPUT (dBm)			Icc (mA)	HARMONICS (dBc)			FREQ. PUSH (MHz/V)	FREQ. PULL (MHz)	PHASE NOISE (dBc/Hz) at offsets				FREQ OFFSET (KHz)	PHASE NOISE at 1895 MHz (dBc/Hz)
		-55°C	+25°C	+85°C	-55°C	+25°C	+85°C		F2	F3	F4			1kHz	10kHz	100kHz	1MHz		
0.00	85.09	1274.1	1263.2	1257.1	7.99	8.59	8.64	27.15	-23.6	-21.6	-41.4	0.06	3.19	-73.4	-99.7	-120.6	-140.7	1.0	-73.47
0.50	79.69	1317.1	1305.7	1299.2	8.24	8.81	8.84	27.41	-22.2	-22.3	-41.1	0.16	2.99	-73.1	-101.2	-122.8	-142.7	2.0	-82.34
2.00	70.73	1435.7	1422.5	1414.4	8.80	9.31	9.29	27.98	-19.3	-27.1	-41.7	0.37	3.91	-74.0	-101.8	-122.9	-143.0	3.5	-89.21
3.00	69.82	1507.8	1493.3	1484.3	9.01	9.50	9.44	28.17	-18.8	-35.3	-38.7	0.44	4.56	-72.8	-100.8	-122.9	-142.8	6.0	-94.97
4.00	69.64	1578.1	1563.1	1553.7	9.16	9.62	9.53	28.30	-18.9	-32.3	-32.1	0.40	4.66	-73.1	-100.7	-122.4	-142.8	8.5	-98.62
5.00	68.62	1648.0	1632.7	1623.4	9.17	9.56	9.44	28.33	-18.5	-30.4	-31.5	0.35	8.13	-74.6	-100.2	-122.1	-142.5	10.0	-100.18
6.00	67.89	1717.1	1701.3	1692.0	9.08	9.48	9.34	28.25	-18.6	-31.3	-32.2	0.29	6.07	-74.3	-100.7	-121.8	-142.4	20.8	-107.81
7.00	67.85	1784.6	1769.2	1760.3	8.99	9.36	9.22	28.19	-18.9	-31.6	-32.8	0.18	7.05	-73.9	-99.2	-121.9	-142.3	35.5	-112.86
8.00	66.91	1852.0	1837.1	1828.5	8.83	9.14	8.99	28.13	-18.6	-31.9	-32.8	0.16	8.18	-74.0	-100.1	-122.4	-142.5	60.7	-117.63
9.00	66.29	1918.8	1904.0	1895.3	8.61	8.97	8.84	27.98	-18.7	-33.5	-32.5	0.12	7.60	-74.0	-99.6	-122.2	-142.8	86.7	-120.98
10.00	66.44	1984.6	1970.3	1962.1	8.41	8.79	8.66	27.93	-19.9	-32.9	-32.7	0.02	8.73	-73.0	-100.8	-122.3	-142.9	100.0	-122.23
11.00	65.09	2050.6	2036.7	2028.7	8.19	8.58	8.48	27.87	-20.3	-28.0	-34.2	0.17	7.62	-73.1	-100.0	-122.2	-142.8	148.1	-125.70
12.00	63.47	2115.9	2101.8	2093.7	7.90	8.39	8.33	27.74	-21.9	-22.2	-37.7	0.37	7.80	-72.8	-99.5	-121.8	-142.3	177.0	-127.26
13.00	62.31	2179.2	2165.3	2157.4	7.55	8.12	8.07	27.69	-24.8	-20.4	-42.7	0.66	9.08	-72.6	-99.5	-121.4	-141.7	211.6	-128.88
14.00	58.95	2241.1	2227.6	2219.6	7.31	7.87	7.83	27.65	-30.3	-21.0	-40.1	0.89	8.26	-71.1	-99.3	-121.1	-141.8	302.4	-132.01
15.00	56.79	2300.0	2286.5	2278.7	7.03	7.58	7.57	27.58	-31.7	-21.5	-37.6	1.10	6.63	-71.1	-98.8	-120.8	-141.6	361.5	-133.55
16.00	52.08	2356.0	2343.3	2335.6	6.88	7.41	7.33	27.58	-28.5	-20.3	-36.8	1.23	4.09	-71.3	-99.0	-121.3	-142.2	507.5	-136.61
17.00	48.73	2408.8	2395.4	2387.6	6.55	7.07	7.08	27.46	-26.8	-21.6	-38.3	1.48	7.05	-71.3	-100.1	-121.3	-142.0	606.7	-138.19
18.00	43.12	2456.6	2444.1	2436.7	6.43	7.05	7.01	27.54	-25.5	-22.0	-39.7	1.77	7.83	-72.3	-98.9	-121.2	-141.9	851.6	-141.19
20.00	31.06	2538.4	2525.6	2517.8	6.01	6.54	6.50	27.49	-27.0	-21.2	-38.2	2.48	8.04	-70.5	-98.9	-121.2	-141.3	1000.0	-142.65

\*at 25°C unless mentioned otherwise

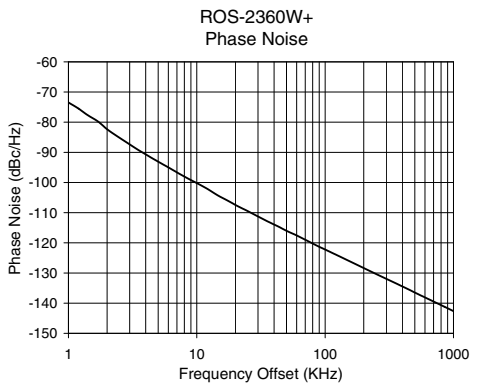
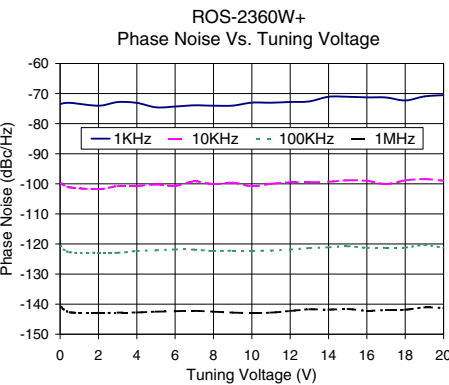
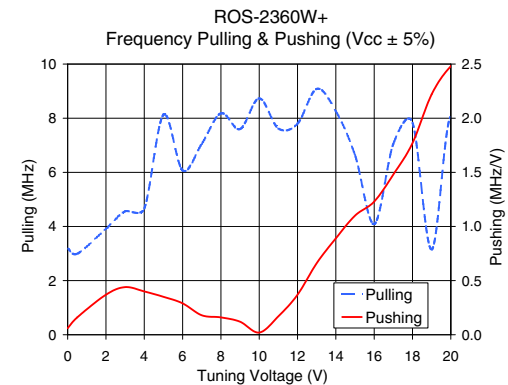
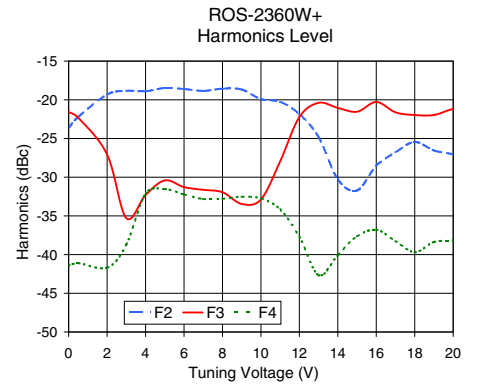
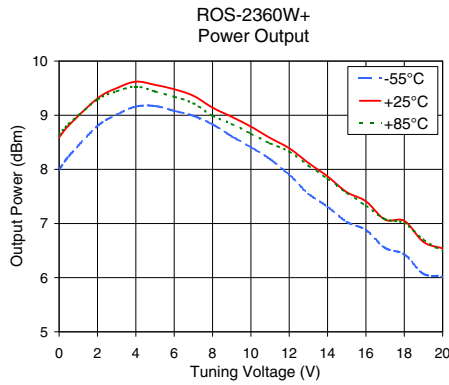
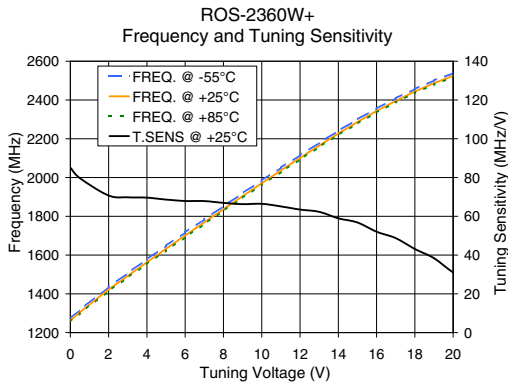

**Notes**

- A. Performance and quality attributes and conditions not expressly stated in this specification document are intended to be excluded and do not form a part of this specification document.
- B. Electrical specifications and performance data contained in this specification document are based on Mini-Circuits' applicable established test performance criteria and measurement instructions.
- C. The parts covered by this specification document are subject to Mini-Circuits standard limited warranty and terms and conditions (collectively, "Standard Terms"); Purchasers of this part are entitled to the rights and benefits contained therein. For a full statement of the Standard Terms and the exclusive rights and remedies thereunder, please visit Mini-Circuits' website at [www.minicircuits.com/MCLStore/terms.jsp](http://www.minicircuits.com/MCLStore/terms.jsp)

