

NON-CATALOG

Surface Mount

Voltage Controlled Oscillator

ROS-1950-519+

Linear Tuning 1780 to 1950 MHz



CASE STYLE: CK605

Features

- linear tuning characteristics
- low phase noise
- low pushing
- low pulling
- aqueous washable

Applications

- wireless communications
- high capacity radio link

+RoHS Compliant

The +Suffix identifies RoHS Compliance. See our web site for RoHS Compliance methodologies and qualifications

Electrical Specifications

MODEL NO.	FREQ. (MHz)		POWER OUTPUT (dBm)	PHASE NOISE dBc/Hz SSB at offset frequencies, kHz				TUNING					NON HARMONIC SPURIOUS (dBc)	HARMONICS (dBc)		PULLING pk-pk @ 12 dB (MHz)	PUSHING (MHz/V)	DC OPERATING POWER				
	Min.	Max.		Typ.	1	10	100	1000	Min.	Max.	Typ.	Typ.		Typ.	Typ.			Max.	Typ.	Typ.	Vcc (volts)	Current (mA)
ROS-1950-519+	1780	1950	+3	-85	-110	-130	-150	0.5	11	22-25	18	120	-90	-20	-10	0.5	0.5	5	35			

Pin Connections

RF OUT	10
VCC	14
V-TUNE	2
GROUND	1, 3, 4, 5, 6, 7, 8, 9, 11, 12, 13, 15, 16

Maximum Ratings

Operating Temperature	-55°C to 85°C
Storage Temperature	-55°C to 100°C
Absolute Max. Supply Voltage (Vcc)	7V
Absolute Max. Tuning Voltage (Vtune)	13V
All specifications	50 ohm system

Permanent damage may occur if any of these limits are exceeded.

Tape & Reel: F37

7" Reels with 10, 20, 50, 100 devices
13" Reels with 200, 500 devices

Environmental Ratings: ENV65

Outline Drawing

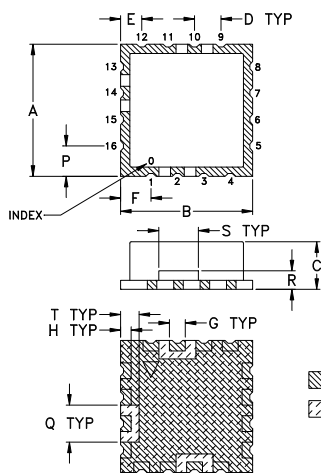

PCB Land Pattern

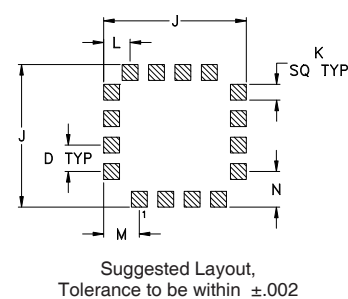

Demo Board MCL P/N: TB-10 Suggested PCB Layout (PL-012)

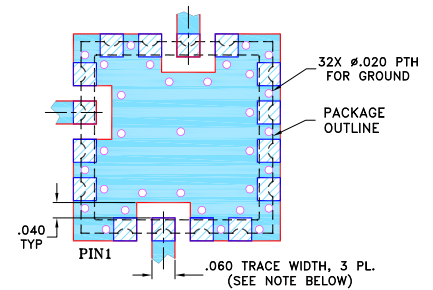

NOTES:

1. TRACE WIDTH IS SHOWN FOR FR4 WITH DIELECTRIC THICKNESS .030" ± .002"; COPPER: 1/2 OZ. EACH SIDE. FOR OTHER MATERIALS TRACE WIDTH MAY NEED TO BE MODIFIED.
 2. BOTTOM SIDE OF THE BOTTOM IS CONTINUOUS GROUND PLANE.
-

Outline Dimensions (inch mm)

A	B	C	D	E	F	G	H	J	K	L	M	N	P	Q	R	S	T	wt.
.500	.500	.180	.100	.080	.115	.060	.040	.540	.060	.100	.135	.135	.115	.140	.070	.150	.070	grams
12.70	12.70	4.57	2.54	2.03	2.92	1.52	1.02	13.72	1.52	2.54	3.43	3.43	2.92	3.56	1.78	3.81	1.78	1.0

Notes

- A. Performance and quality attributes and conditions not expressly stated in this specification document are intended to be excluded and do not form a part of this specification document.
B. Electrical specifications and performance data contained in this specification document are based on Mini-Circuit's applicable established test performance criteria and measurement instructions.
C. The parts covered by this specification document are subject to Mini-Circuits standard limited warranty and terms and conditions (collectively, "Standard Terms"); Purchasers of this part are entitled to the rights and benefits contained therein. For a full statement of the Standard Terms and the exclusive rights and remedies thereunder, please visit Mini-Circuits' website at www.minicircuits.com/MCLStore/terms.jsp



www.minicircuits.com P.O. Box 350166, Brooklyn, NY 11235-0003 (718) 934-4500 sales@minicircuits.com

REV. C
M169213
EDR-8217/2F1
ROS-1950-519+
RAV
180813
Page 1 of 2

NON-CATALOG

Performance Data & Curves*

ROS-1950-519+

V TUNE	TUNE SENS (MHz/V)	FREQUENCY (MHz)			POWER OUTPUT (dBm)			Icc (mA)	HARMONICS (dBc)			FREQ. PUSH (MHz/V)	FREQ. PULL (MHz)	PHASE NOISE (dBc/Hz) at offsets				FREQ OFFSET (KHz)	PHASE NOISE at 1865 MHz (dBc/Hz)
		-55°C	+25°C	+85°C	-55°C	+25°C	+85°C		F2	F3	F4			1kHz	10kHz	100kHz	1MHz		
0.00	26.16	1733.4	1728.0	1723.6	2.91	3.47	3.49	26.77	-49.3	-19.5	-33.8	0.25	0.53	-85.0	-109.4	-129.4	-149.5	1.0	-84.49
0.50	23.26	1746.3	1741.1	1736.8	2.84	3.45	3.50	26.88	-51.2	-19.8	-34.0	0.33	0.56	-85.7	-110.1	-129.8	-150.0	2.0	-92.73
1.00	22.12	1758.0	1752.7	1748.3	2.79	3.40	3.47	26.99	-52.1	-20.6	-33.1	0.36	0.52	-86.1	-110.0	-130.1	-150.1	3.5	-99.33
1.50	21.71	1769.2	1763.8	1759.2	2.77	3.38	3.45	27.09	-53.7	-21.0	-33.3	0.37	0.58	-86.7	-110.4	-130.4	-150.3	6.0	-105.13
2.00	21.72	1780.2	1774.7	1769.8	2.76	3.38	3.45	27.18	-52.9	-21.1	-33.1	0.38	0.51	-85.6	-110.2	-130.5	-150.8	8.5	-108.79
2.50	21.86	1791.3	1785.5	1780.5	2.77	3.37	3.44	27.29	-52.5	-21.6	-32.8	0.38	0.34	-87.5	-110.2	-130.9	-150.7	10.0	-110.15
3.00	22.10	1802.4	1796.4	1791.2	2.80	3.40	3.45	27.39	-50.1	-22.2	-33.0	0.38	0.25	-86.5	-111.4	-131.1	-151.0	20.8	-116.94
3.50	22.37	1813.7	1807.5	1802.1	2.81	3.41	3.48	27.50	-53.2	-22.5	-32.8	0.38	0.28	-86.9	-111.3	-131.2	-150.9	35.5	-121.69
4.00	22.59	1825.0	1818.7	1813.1	2.85	3.43	3.49	27.61	-53.7	-23.0	-32.4	0.37	0.37	-86.2	-110.7	-131.1	-150.9	60.7	-126.51
4.50	22.78	1836.5	1830.0	1824.2	2.87	3.47	3.52	27.73	-50.4	-23.1	-32.7	0.35	0.40	-85.5	-110.0	-131.2	-150.8	86.7	-129.73
5.00	22.96	1848.0	1841.4	1835.5	2.87	3.49	3.55	27.86	-52.0	-23.5	-32.2	0.34	0.41	-84.6	-110.7	-131.0	-151.0	100.0	-130.98
5.50	23.12	1859.7	1852.8	1846.8	2.90	3.50	3.55	27.99	-50.8	-24.0	-32.5	0.32	0.32	-84.2	-110.3	-130.9	-150.7	148.1	-134.28
6.00	23.21	1871.3	1864.4	1858.2	2.92	3.52	3.57	28.12	-51.4	-24.4	-31.9	0.31	0.29	-84.0	-110.8	-130.9	-150.8	177.0	-135.91
6.50	23.34	1883.0	1876.0	1869.7	2.97	3.54	3.59	28.27	-52.0	-24.5	-31.9	0.30	0.23	-83.7	-109.9	-130.6	-150.8	211.6	-137.48
7.00	23.44	1894.9	1887.7	1881.2	3.02	3.60	3.63	28.41	-52.8	-25.0	-32.0	0.29	0.25	-81.8	-109.6	-130.7	-150.6	302.4	-140.52
7.50	23.45	1906.7	1899.4	1892.8	3.08	3.65	3.68	28.56	-50.3	-25.4	-31.2	0.30	0.27	-83.5	-110.0	-130.4	-150.4	361.5	-141.93
8.00	23.60	1918.6	1911.1	1904.5	3.12	3.70	3.73	28.71	-49.1	-25.8	-32.2	0.31	0.28	-84.9	-109.5	-130.1	-150.2	507.5	-145.05
9.00	23.67	1942.4	1934.8	1927.8	3.17	3.77	3.82	29.03	-49.1	-26.4	-32.0	0.38	0.14	-83.9	-108.6	-129.5	-149.8	606.7	-146.53
10.00	23.57	1966.4	1958.5	1951.2	3.22	3.83	3.89	29.38	-47.3	-27.0	-31.7	0.49	0.14	-82.1	-108.0	-129.0	-149.0	851.6	-149.34
11.00	23.61	1990.5	1982.1	1974.5	3.34	3.93	3.98	29.76	-47.5	-27.9	-31.8	0.53	0.16	-82.0	-106.6	-127.6	-147.8	1000.0	-150.14

*at 25°C unless mentioned otherwise

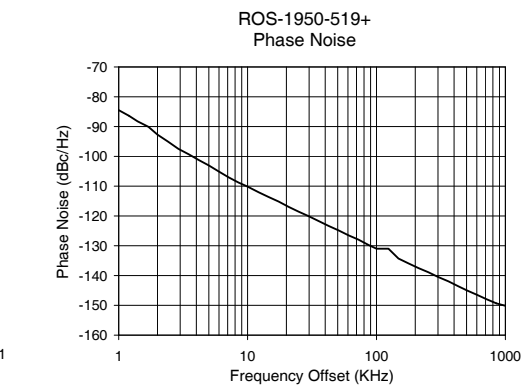
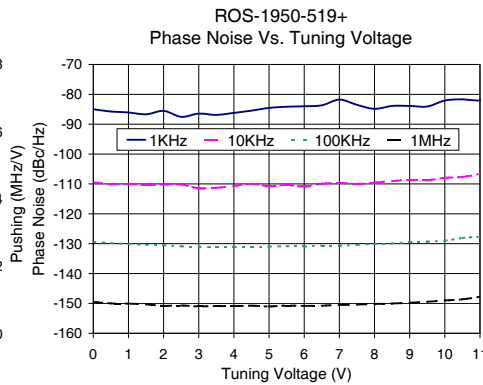
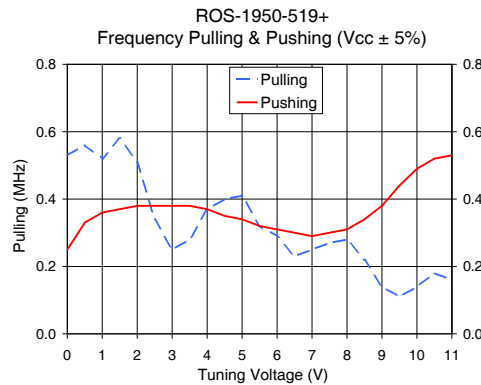
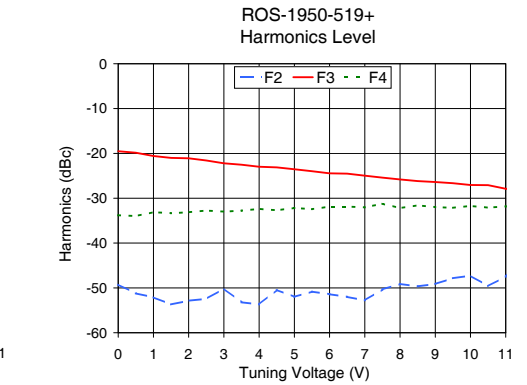
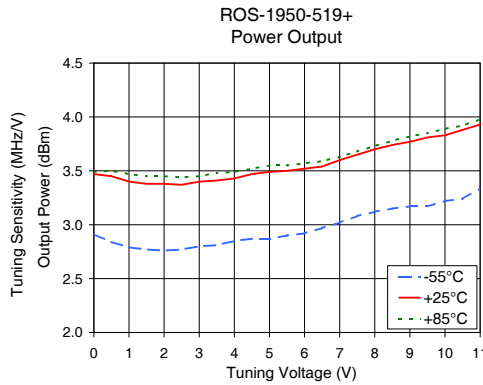
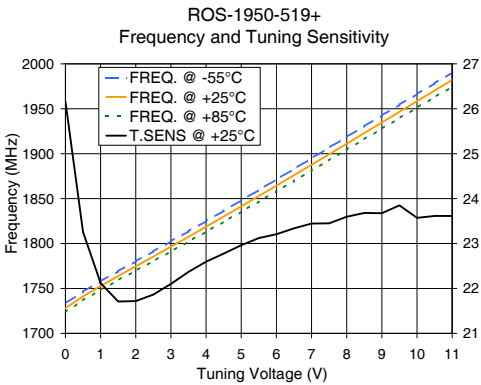

Notes

- A. Performance and quality attributes and conditions not expressly stated in this specification document are intended to be excluded and do not form a part of this specification document.
- B. Electrical specifications and performance data contained in this specification document are based on Mini-Circuits' applicable established test performance criteria and measurement instructions.
- C. The parts covered by this specification document are subject to Mini-Circuits standard limited warranty and terms and conditions (collectively, "Standard Terms"); Purchasers of this part are entitled to the rights and benefits contained therein. For a full statement of the Standard Terms and the exclusive rights and remedies thereunder, please visit Mini-Circuits' website at www.minicircuits.com/MCLStore/terms.jsp

