

Voltage Controlled Oscillator

ROS-1357+

5V Tuning for PLL IC's 1338 to 1357 MHz

Features

- linear tuning characteristics
- low phase noise
- low pushing
- low pulling
- aqueous washable

Applications

- wireless communications
- synthesizer



CASE STYLE: CK605

+RoHS Compliant

The +Suffix identifies RoHS Compliance. See our web site for RoHS Compliance methodologies and qualifications

Electrical Specifications

MODEL NO.	FREQ. (MHz)		POWER OUTPUT (dBm)	PHASE NOISE dBc/Hz SSB at offset frequencies, kHz				TUNING					NON HARMONIC SPURIOUS (dBc)	HARMONICS (dBc)		PULLING pk-pk @12 dB (MHz)	PUSHING (MHz/V)	DC OPERATING POWER					
	Min.	Max.		Typ.	1	10	100	1000	VOLTAGE RANGE (V)	SENSI- TIVITY (MHz/V)	PORT CAP (pF)	3 dB MODULATION BANDWIDTH (MHz)		Typ.	Typ.			Typ.	Max.	Typ.	Typ.	Vcc (volts)	Current (mA)
ROS-1357+	1338	1357	0	-86	-110	-131	-151	0.5	5	12	40	50	-90	-22	-13	0.3	0.4	5	37				

Pin Connections

RF OUT	10
VCC	14
V-TUNE	2
GROUND	1,3,4,5,6,7,8,9,11,12,13,15,16

Maximum Ratings

Operating Temperature	-55°C to 85°C
Storage Temperature	-55°C to 100°C
Absolute Max. Supply Voltage (Vcc)	6.5V
Absolute Max. Tuning Voltage (Vtune)	7V
All specifications	50 ohm system

Permanent damage may occur if any of these limits are exceeded.

Tape & Reel: F37

7" Reels with 10, 20, 50, 100 devices
13" Reels with 200, 500 devices

Environmental Ratings: ENV65

Outline Drawing

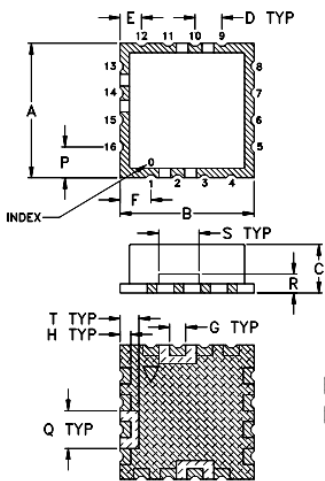

PCB Land Pattern

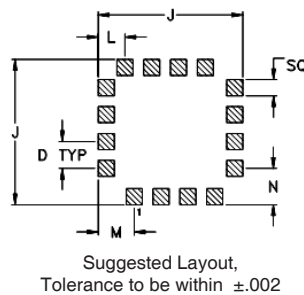

METALLIZATION
 SOLDER RESIST

Demo Board MCL P/N: TB-10 Suggested PCB Layout (PL-012)

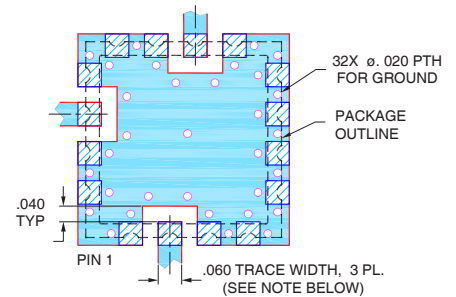

NOTES:

1. TRACE WIDTH IS SHOWN FOR FR4 WITH DIELECTRIC THICKNESS .030" ± .002"; COPPER: 1/2 OZ. EACH SIDE. FOR OTHER MATERIALS TRACE WIDTH MAY NEED TO BE MODIFIED.
2. BOTTOM SIDE OF THE PCB IS CONTINUOUS GROUND PLANE.
 - DENOTES PCB COPPER LAYOUT WITH SMOBC (SOLDER MASK OVER BARE COPPER)
 - DENOTES COPPER LAND PATTERN FREE OF SOLDER MASK

Outline Dimensions (inch/mm)

A	B	C	D	E	F	G	H	J	K	L	M	N	P	Q	R	S	T	wt.
.500	.500	.180	.100	.080	.115	.060	.040	.540	.060	.100	.135	.135	.115	.140	.070	.150	.070	grams
12.70	12.70	4.57	2.54	2.03	2.92	1.52	1.02	13.72	1.52	2.54	3.43	3.43	2.92	3.56	1.78	3.81	1.78	1.0

Notes

- A. Performance and quality attributes and conditions not expressly stated in this specification document are intended to be excluded and do not form a part of this specification document.
- B. Electrical specifications and performance data contained in this specification document are based on Mini-Circuits' applicable established test performance criteria and measurement instructions.
- C. The parts covered by this specification document are subject to Mini-Circuits standard limited warranty and terms and conditions (collectively, "Standard Terms"); Purchasers of this part are entitled to the rights and benefits contained therein. For a full statement of the Standard Terms and the exclusive rights and remedies thereunder, please visit Mini-Circuits' website at www.minicircuits.com/MCLStore/terms.jsp



Performance Data & Curves*

ROS-1357+

V TUNE	TUNE SENS (MHz/V)	FREQUENCY (MHz)			POWER OUTPUT (dBm)			Icc (mA)	HARMONICS (dBc)			FREQ. PUSH (MHz/V)	FREQ. PULL (MHz)	PHASE NOISE (dBc/Hz) at offsets				FREQ OFFSET (KHz)	PHASE NOISE at 1348 MHz (dBc/Hz)
		-55°C	+25°C	+85°C	-55°C	+25°C	+85°C		F2	F3	F4			1kHz	10kHz	100kHz	1MHz		
0.00	22.71	1309.9	1307.0	1304.0	0.55	-0.34	-0.66	29.98	-21.3	-29.3	-24.5	0.06	0.30	-81.9	-107.7	-128.4	-147.7	1.0	-87.47
0.50	17.50	1320.3	1317.6	1314.7	0.52	-0.26	-0.57	30.05	-21.4	-28.9	-24.4	0.28	0.39	-83.9	-108.0	-128.8	-148.4	2.0	-96.00
0.75	16.07	1324.7	1321.9	1319.1	0.49	-0.23	-0.54	30.08	-21.4	-28.8	-24.2	0.32	0.44	-83.7	-108.9	-128.9	-148.3	3.5	-100.91
1.00	15.01	1328.7	1325.9	1323.1	0.48	-0.20	-0.51	30.10	-21.4	-28.6	-24.1	0.35	0.50	-83.7	-109.0	-129.4	-149.1	6.0	-105.59
1.25	14.32	1332.5	1329.7	1326.9	0.46	-0.19	-0.49	30.13	-21.5	-28.5	-24.2	0.36	0.55	-85.8	-109.0	-129.7	-149.6	8.5	-109.03
1.50	13.77	1336.2	1333.3	1330.4	0.42	-0.19	-0.47	30.15	-21.4	-28.6	-24.5	0.37	0.57	-85.5	-109.2	-130.0	-149.3	10.0	-110.45
1.75	13.35	1339.8	1336.7	1333.8	0.38	-0.18	-0.46	30.17	-21.4	-28.7	-24.5	0.37	0.55	-84.8	-109.3	-130.2	-149.4	20.8	-117.26
2.00	12.99	1343.2	1340.1	1337.1	0.34	-0.17	-0.45	30.20	-21.4	-28.9	-24.3	0.38	0.51	-84.7	-110.2	-130.3	-149.8	35.5	-121.35
2.25	12.67	1346.6	1343.3	1340.3	0.34	-0.16	-0.44	30.22	-21.5	-28.9	-24.1	0.38	0.45	-84.9	-109.6	-130.6	-151.4	60.7	-126.18
2.50	12.38	1349.8	1346.5	1343.4	0.34	-0.14	-0.42	30.24	-21.6	-28.7	-24.0	0.38	0.36	-86.4	-109.9	-130.8	-150.3	86.7	-130.02
2.75	12.23	1353.0	1349.6	1346.5	0.32	-0.12	-0.40	30.25	-21.6	-28.5	-24.2	0.38	0.26	-87.6	-110.0	-130.8	-150.7	100.0	-131.04
3.00	12.11	1356.1	1352.6	1349.5	0.30	-0.11	-0.38	30.27	-21.7	-28.4	-24.4	0.38	0.19	-87.5	-110.6	-131.5	-150.8	148.1	-134.17
3.25	12.04	1359.3	1355.7	1352.5	0.27	-0.10	-0.37	30.29	-21.7	-28.2	-24.4	0.38	0.18	-86.2	-109.8	-131.1	-151.2	177.0	-135.71
3.50	11.97	1362.4	1358.7	1355.5	0.25	-0.09	-0.36	30.31	-21.6	-28.0	-24.5	0.38	0.26	-87.1	-109.6	-131.5	-150.8	211.6	-137.08
3.75	11.90	1365.5	1361.7	1358.4	0.25	-0.08	-0.35	30.33	-21.5	-27.7	-24.5	0.39	0.36	-88.4	-109.6	-131.3	-150.5	302.4	-139.59
4.00	11.84	1368.5	1364.6	1361.3	0.26	-0.07	-0.34	30.34	-21.4	-27.5	-24.4	0.39	0.44	-88.6	-110.2	-131.4	-151.4	361.5	-139.43
4.25	11.84	1371.6	1367.6	1364.2	0.26	-0.05	-0.33	30.35	-21.3	-27.5	-24.5	0.39	0.50	-86.8	-110.5	-131.4	-152.2	507.5	-144.57
4.50	11.90	1374.7	1370.5	1367.2	0.25	-0.03	-0.31	30.37	-21.2	-27.7	-24.4	0.39	0.54	-87.2	-110.6	-131.6	-151.6	606.7	-145.67
4.75	11.93	1377.7	1373.5	1370.1	0.26	-0.01	-0.29	30.38	-21.1	-27.7	-24.3	0.39	0.59	-87.8	-110.1	-132.0	-151.6	851.6	-150.03
5.00	11.97	1380.8	1376.5	1373.0	0.27	0.00	-0.27	30.40	-21.1	-27.8	-24.4	0.39	0.62	-89.4	-111.4	-131.7	-151.6	1000.0	-150.65

*at 25°C unless mentioned otherwise

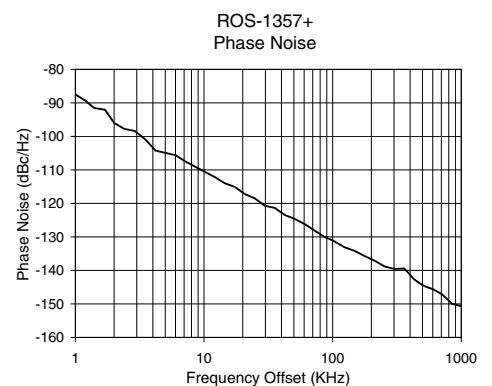
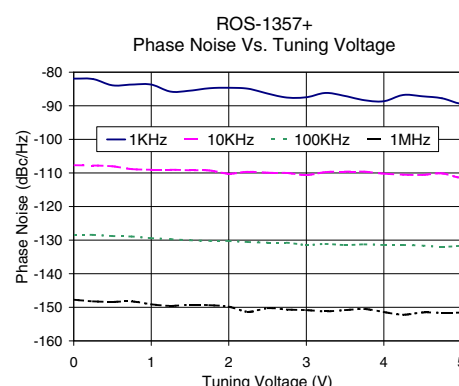
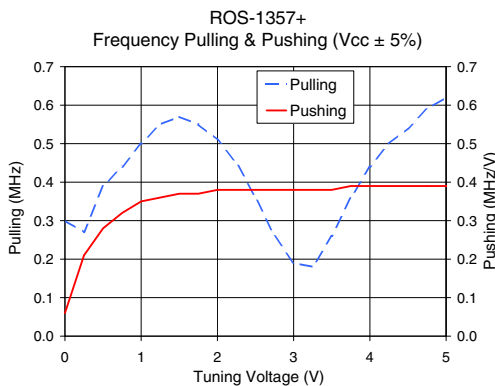
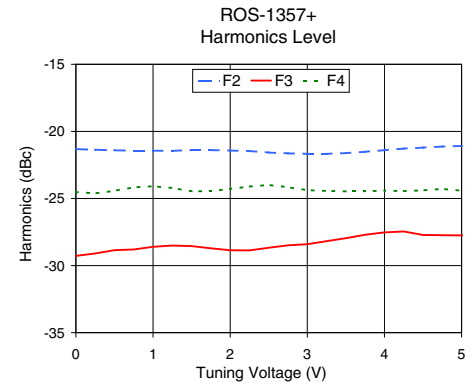
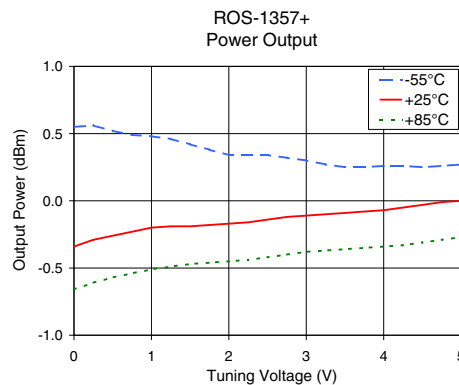
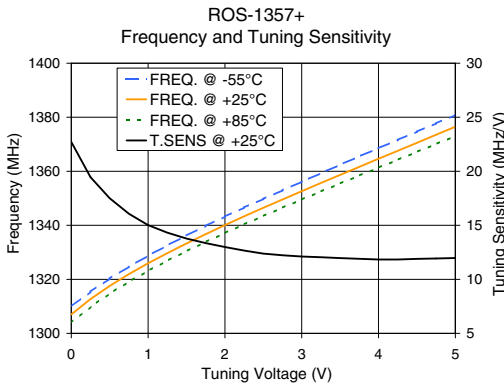

Notes

- A. Performance and quality attributes and conditions not expressly stated in this specification document are intended to be excluded and do not form a part of this specification document.
- B. Electrical specifications and performance data contained in this specification document are based on Mini-Circuit's applicable established test performance criteria and measurement instructions.
- C. The parts covered by this specification document are subject to Mini-Circuits standard limited warranty and terms and conditions (collectively, "Standard Terms"); Purchasers of this part are entitled to the rights and benefits contained therein. For a full statement of the Standard Terms and the exclusive rights and remedies thereunder, please visit Mini-Circuits' website at www.minicircuits.com/MCLStore/terms.jsp

