

NON-CATALOG

Surface Mount

Voltage Controlled Oscillator

JTOS-3000P

5V Tuning for PLL IC's 2300 to 2600 MHz

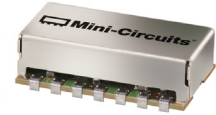

CASE STYLE: BK377

Features

- low phase noise
- 5V tuning voltage range
- linear tuning characteristics
- aqueous washable

Applications

- PLL circuitry
- measurement instrumentation
- frequency synthesizers

+RoHS Compliant

The +Suffix identifies RoHS Compliance. See our web site for RoHS Compliance methodologies and qualifications

Electrical Specifications

FREQUENCY (MHz)		POWER OUTPUT (dBm)	TUNING VOLTAGE (V)		PHASE NOISE (dBc/Hz)				PULLING pk-pk @ 12 dB (MHz)	PUSHING (MHz/V)	TUNING SENSITIVITY (MHz/V)	HARMONICS (dBc)		3 dB MODULATION BANDWIDTH (MHz)	POWER SUPPLY	
Min.	Max.		Min.	Max.	SSB at offset frequencies: Typ.							Typ.	Typ.		Typ.	Max.
		Typ.			1 kHz	10 kHz	100 kHz	1 MHz	Typ.	Typ.	Typ.			Typ.		Max.
2300	2600	+11	0.5	5.0	-65	-92	-112	-132	50.0	5.0	120-160	-22	-12	20	5	25

Pin Connections

RF OUT	13
VCC	2
V-TUNE	5
GROUND	1,3,4,6,7,8,9,10,11,12,14

Maximum Ratings

Operating Temperature	-55°C to 85°C
Storage Temperature	-55°C to 100°C
Absolute Max. Supply Voltage (Vcc)	+7V
Absolute Max. Tuning Voltage (Vtune)	+7V

all specifications: 50 ohm system
Permanent damage may occur if any of these limits are exceeded.

Outline Drawing

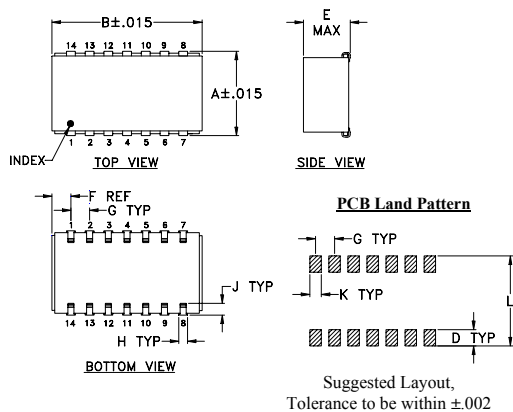

Demo Board MCL PIN: TB-04 Suggested PCB Layout (PL-005)

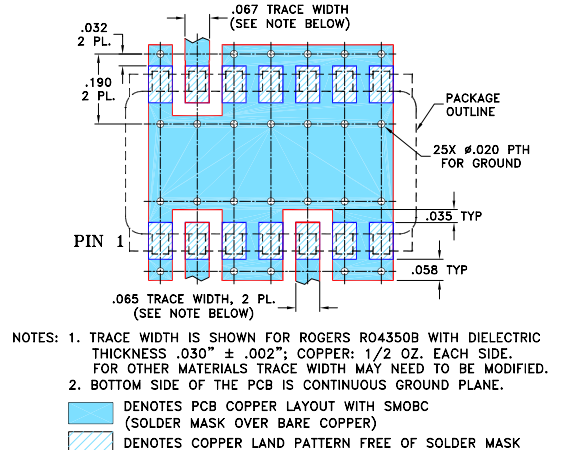

Outline Dimensions (inch/mm)

A	B	C	D	E	F	G	H	J	K	L	wt
.505	.800	--	.100	.250	.100	.100	.047	.065	.065	.525	grams
12.83	20.32	--	2.54	6.35	2.54	2.54	1.19	1.65	1.65	13.34	3.0

Notes

- A. Performance and quality attributes and conditions not expressly stated in this specification document are intended to be excluded and do not form a part of this specification document.
 B. Electrical specifications and performance data contained in this specification document are based on Mini-Circuit's applicable established test performance criteria and measurement instructions.
 C. The parts covered by this specification document are subject to Mini-Circuits standard limited warranty and terms and conditions (collectively, "Standard Terms"); Purchasers of this part are entitled to the rights and benefits contained therein. For a full statement of the Standard Terms and the exclusive rights and remedies thereunder, please visit Mini-Circuits' website at www.minicircuits.com/MCLStore/terms.jsp



NON-CATALOG

Performance Data & Curves

JTOS-3000P

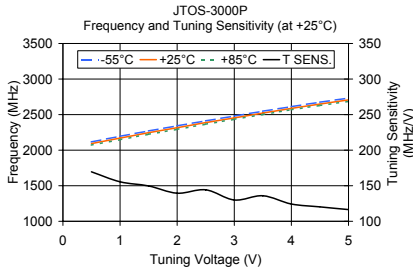

V TUNE	TUNING SENS. (MHz/V)	FREQUENCY (MHz)			POWER OUTPUT (dBm)		
		-55°C	+25°C	+85°C	-55°C	+25°C	+85°C
0.50	169.56	2116.65	2092.43	2071.53	10.64	10.54	10.15
1.00	155.58	2195.29	2169.49	2148.48	11.34	11.35	10.92
1.50	149.69	2270.64	2245.86	2223.70	11.62	11.53	11.11
2.00	139.47	2342.50	2315.57	2293.39	11.86	12.01	11.61
2.50	144.29	2413.01	2387.44	2364.81	12.22	12.14	11.70
3.00	129.94	2479.91	2453.47	2434.20	12.32	12.35	11.73
3.50	135.93	2548.18	2521.73	2501.82	12.36	12.30	11.94
4.00	124.26	2612.02	2587.12	2568.68	12.27	12.27	11.70
4.50	120.22	2674.56	2648.09	2628.71	12.19	12.27	11.95
5.00	116.49	2732.38	2706.89	2686.01	11.67	12.10	11.80

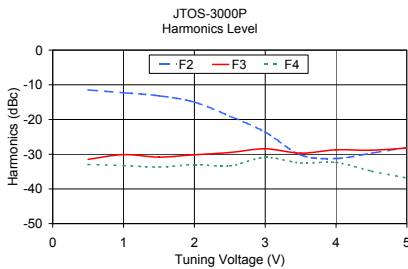
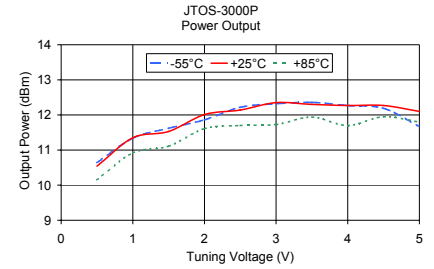

V TUNE	HARMONICS (dBc)			FREQ. PUSHING (MHz/V)
	F2	F3	F4	
0.50	-11.47	-31.47	-32.97	3.59
1.00	-12.27	-30.11	-33.27	0.38
1.50	-13.17	-30.83	-33.67	1.27
2.00	-14.99	-30.15	-32.99	1.54
2.50	-19.00	-29.50	-33.33	0.13
3.00	-23.60	-28.43	-30.93	2.30
3.50	-30.19	-29.69	-32.52	4.61
4.00	-31.22	-28.72	-32.38	5.77
4.50	-29.69	-28.85	-34.85	5.64
5.00	-28.05	-28.21	-36.88	4.62

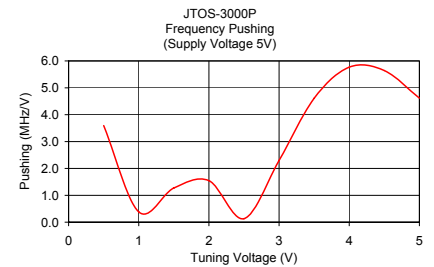

Notes

- Performance and quality attributes and conditions not expressly stated in this specification document are intended to be excluded and do not form a part of this specification document.
- Electrical specifications and performance data contained in this specification document are based on Mini-Circuit's applicable established test performance criteria and measurement instructions.
- The parts covered by this specification document are subject to Mini-Circuits standard limited warranty and terms and conditions (collectively, "Standard Terms"); Purchasers of this part are entitled to the rights and benefits contained therein. For a full statement of the Standard Terms and the exclusive rights and remedies thereunder, please visit Mini-Circuits' website at www.minicircuits.com/MCLStore/terms.jsp

