

Surface Mount Voltage Controlled Oscillator

JTOS-150P+ JTOS-150P

5V Tuning for PLL IC's 72 to 91 MHz

Features

- low phase noise
- 5V tuning voltage range
- linear tuning characteristics
- aqueous washable

Applications

- PLL circuitry
- measurement instrumentation
- frequency synthesizers

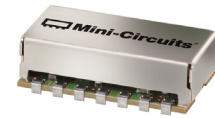

CASE STYLE: BK377
PRICE: \$14.95 ea. QTY (20)

+RoHS Compliant

The +Suffix identifies RoHS Compliance. See our web site for RoHS Compliance methodologies and qualifications

Electrical Specifications

FREQUENCY (MHz)		POWER OUTPUT (dBm)	TUNING VOLTAGE (V)		PHASE NOISE (dBc/Hz)				PULLING pk-pk @ 12 dB (MHz)	PUSHING (MHz/V)	TUNING SENSITIVITY (MHz/V)	HARMONICS (dBc)		3 dB MODULATION BANDWIDTH (MHz)	POWER SUPPLY	
Min.	Max.		Min.	Max.	SSB at offset frequencies: Typ.							Typ.	Typ.		Typ.	Max.
		Typ.			1 kHz	10 kHz	100 kHz	1 MHz								
72	91	+9.5	0.5	5.0	-82	-106	-127	-147	0.8	0.3	6-9	-30	-17	0.112	12	20

Pin Connections

RF OUT	13
VCC	2
V-TUNE	5
GROUND	1,3,4,6,7,8,9,10,11,12,14

Maximum Ratings

Operating Temperature	-55°C to 85°C
Storage Temperature	-55°C to 100°C
Absolute Max. Supply Voltage (Vcc)	+16V
Absolute Max. Tuning Voltage (Vtune)	+7V

all specifications: 50 ohm system
Permanent damage may occur if any of these limits are exceeded.

Outline Drawing

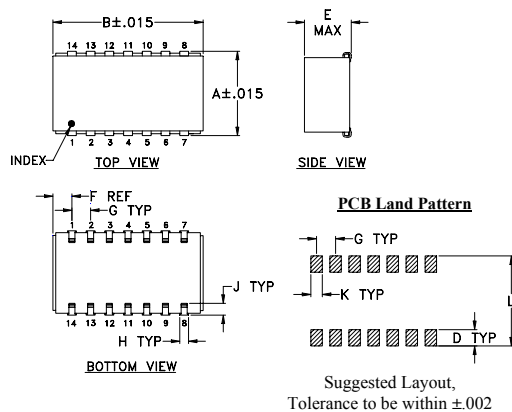

Demo Board MCL PIN: TB-04 Suggested PCB Layout (PL-005)

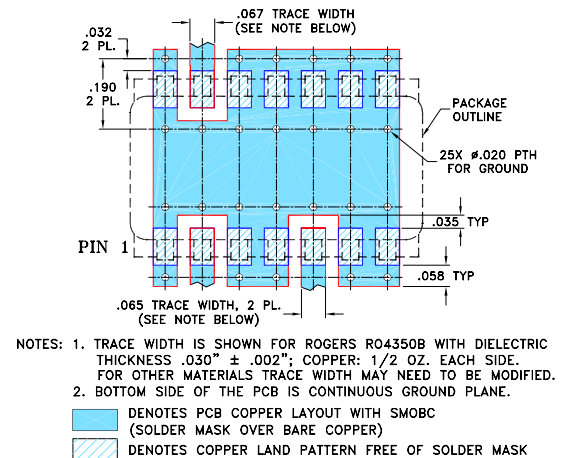

Outline Dimensions (inch/mm)

A	B	C	D	E	F	G	H	J	K	L	wt
.505	.800	--	.100	.250	.100	.100	.047	.065	.065	.525	grams
12.83	20.32	--	2.54	6.35	2.54	2.54	1.19	1.65	1.65	13.34	3.0

Notes

- Performance and quality attributes and conditions not expressly stated in this specification document are intended to be excluded and do not form a part of this specification document.
- Electrical specifications and performance data contained in this specification document are based on Mini-Circuit's applicable established test performance criteria and measurement instructions.
- The parts covered by this specification document are subject to Mini-Circuits standard limited warranty and terms and conditions (collectively, "Standard Terms"); Purchasers of this part are entitled to the rights and benefits contained therein. For a full statement of the Standard Terms and the exclusive rights and remedies thereunder, please visit Mini-Circuits' website at www.minicircuits.com/MCLStore/terms.jsp



JTOS-150P+ JTOS-150P

Performance Data & Curves

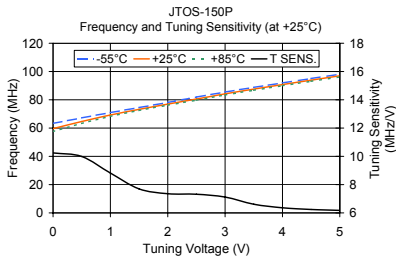

V TUNE	TUNING SENS. (MHz/V)	FREQUENCY (MHz)			POWER OUTPUT (dBm)		
		-55°C	+25°C	+85°C	-55°C	+25°C	+85°C
0.00	10.24	63.31	59.60	57.51	7.72	7.18	6.61
0.50	9.99	67.21	64.66	63.26	8.59	8.46	8.11
1.00	8.82	70.96	69.22	68.25	9.43	9.62	9.45
1.50	7.70	74.52	73.21	72.43	9.95	10.36	10.19
2.00	7.36	78.14	76.93	76.19	9.95	10.30	10.11
2.50	7.32	81.92	80.54	79.77	9.93	10.19	9.97
3.00	7.12	85.50	84.18	83.40	9.89	10.12	9.88
3.50	6.61	88.81	87.54	86.76	9.83	10.03	9.79
4.00	6.36	91.97	90.75	89.97	9.75	9.95	9.68
4.50	6.24	95.04	93.89	93.10	9.69	9.84	9.57
5.00	6.18	98.10	96.99	96.21	9.61	9.76	9.49

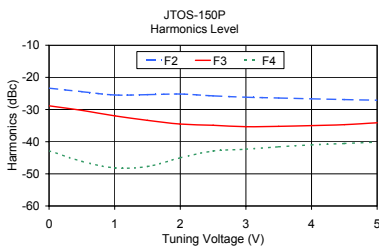
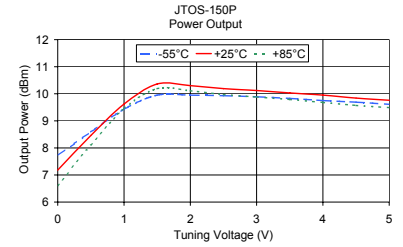

V TUNE	HARMONICS (dBc)			FREQ. PUSHING (MHz/V)
	F2	F3	F4	
0.00	-23.33	-28.83	-42.83	0.00
0.50	-24.44	-30.27	-46.11	0.13
1.00	-25.46	-31.96	-48.13	0.13
1.50	-25.37	-33.37	-47.70	0.32
2.00	-25.17	-34.51	-45.01	0.38
2.50	-25.73	-34.90	-42.90	0.38
3.00	-26.16	-35.33	-42.33	0.19
3.50	-26.40	-35.24	-41.57	0.13
4.00	-26.66	-34.99	-40.99	0.13
4.50	-26.88	-34.71	-40.55	0.13
5.00	-27.11	-34.11	-40.11	0.13

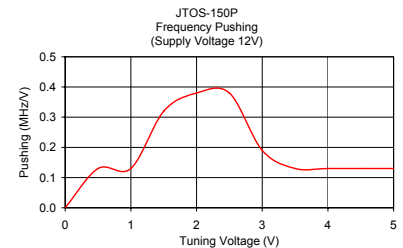

Notes

- Performance and quality attributes and conditions not expressly stated in this specification document are intended to be excluded and do not form a part of this specification document.
- Electrical specifications and performance data contained in this specification document are based on Mini-Circuit's applicable established test performance criteria and measurement instructions.
- The parts covered by this specification document are subject to Mini-Circuits standard limited warranty and terms and conditions (collectively, "Standard Terms"); Purchasers of this part are entitled to the rights and benefits contained therein. For a full statement of the Standard Terms and the exclusive rights and remedies thereunder, please visit Mini-Circuits' website at www.minicircuits.com/MCLStore/terms.jsp

