



CERAMIC

High Pass Filter

HFCN-880D+

50Ω 950 to 3200 MHz

FEATURES

- Low cost
- Small size
- 7 sections
- Temperature stable
- LTCC construction
- Excellent power handling, 7W
- Hermetically sealed

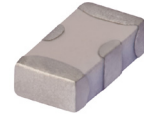

Generic photo used for illustration purposes only

CASE STYLE: FV1206

+RoHS Compliant

The +Suffix identifies RoHS Compliance. See our website for methodologies and qualifications

APPLICATIONS

- Sub-harmonic rejection
- Transmitters/receivers
- Lab use

ELECTRICAL SPECIFICATIONS^{1,2} AT 25°C

Parameter	Frequency (MHz)	Min.	Typ.	Max.	Units	
Stop Band	Rejection Loss	500	40	—	—	dB
		640	20	—	—	
	Freq. Cut-Off	880	—	3.0	—	dB
	VSWR	500-640	—	20	—	:1
Pass Band	Insertion Loss	950-3200	—	2.0	—	dB
		1060-2500	—	—	1.3	dB
	VSWR	970-2400	—	1.5	—	:1

1. DC Resistance to ground is 100 Mohms min.

2. Measured on Mini-Circuits Characterization Test Board TB-270.

ABSOLUTE MAXIMUM RATINGS

Parameter	Ratings
Operating temperature	-55°C to +100°C
Storage temperature	-55°C to +100°C
RF Power Input ³	7W max.at 25°C
Max. DC Voltage at pins 1&3	25 VDC

3. Passband rating, derate linearly to 3W at 100°C ambient.

Permanent damage may occur if any of these limits are exceeded.

TYPICAL FREQUENCY RESPONSE

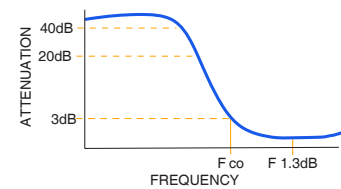

FUNCTIONAL SCHEMATIC

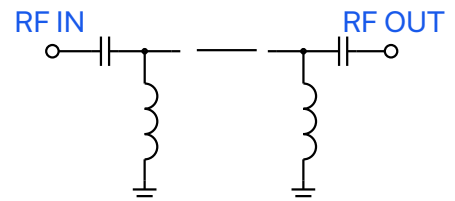



PIN CONNECTIONS

RF IN	1
RF OUT	3
GROUND	2,4

PRODUCT MARKING: F2

DEMO BOARD MCL P/N: TB-270 SUGGESTED PCB LAYOUT (PL-137)

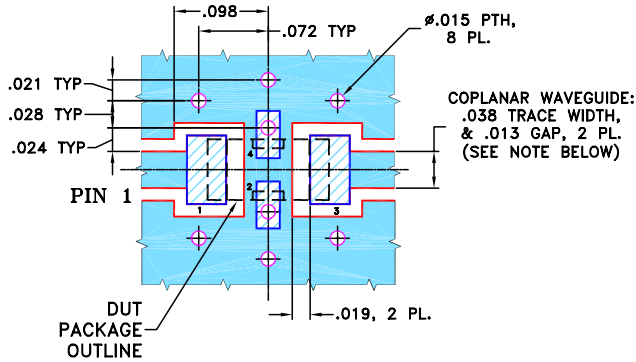

- NOTES:**
1. COPLANAR WAVEGUIDE PARAMETERS ARE SHOWN FOR ROGERS RO4350B WITH THICKNESS .020" ± .0015". COPPER: 1/2 OZ. EACH SIDE. FOR OTHER MATERIALS TRACE WIDTH & GAP MAY NEED TO BE MODIFIED.
 2. BOTTOM SIDE OF THE PCB IS CONTINUOUS GROUND PLANE.

- DENOTES PCB COPPER LAYOUT WITH SMOBC (SOLDER MASK OVER BARE COPPER)
- DENOTES COPPER LAND PATTERN FREE OF SOLDER MASK

OUTLINE DRAWING

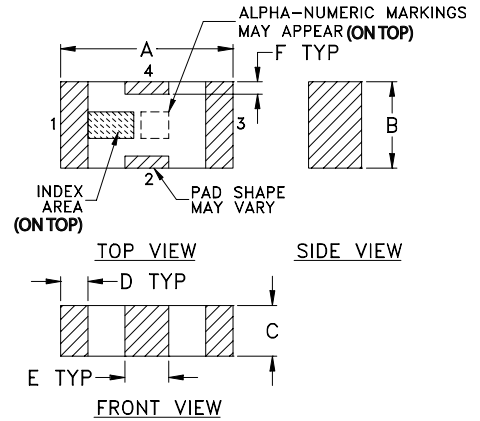

PCB Land Pattern

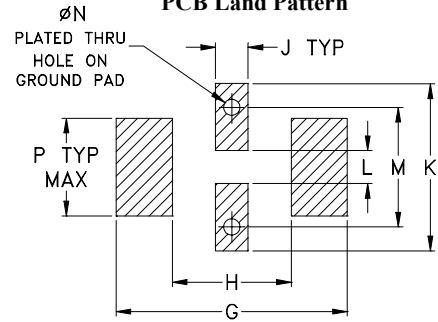

Suggested Layout,
Tolerance to be within ±.002

OUTLINE DIMENSIONS (Inches mm)

A	B	C	D	E	F	G	
.126	.063	.037	.020	.032	.009	.169	
3.20	1.60	0.94	0.51	0.81	0.23	4.29	
H	J	K	L	M	N	P	wt
.087	.024	.122	.024	.087	.012	.071	grams
2.21	0.61	3.10	0.61	2.21	0.30	1.80	.020

TAPE & REEL INFORMATION: F71



CERAMIC

High Pass Filter

HFCN-880D+

TYPICAL PERFORMANCE DATA AT 25°C

Frequency (MHz)	Insertion Loss (dB)	VSWR :1
1.00	82.28	868.59
100.00	78.78	868.59
500.00	45.84	56.04
640.00	23.68	24.14
750.00	10.22	8.68
810.00	4.85	3.84
880.00	1.97	1.83
950.00	1.17	1.36
970.00	1.06	1.32
1060.00	0.83	1.26
2400.00	0.52	1.46
2500.00	0.60	1.58
3200.00	1.42	2.62
5000.00	5.12	7.87

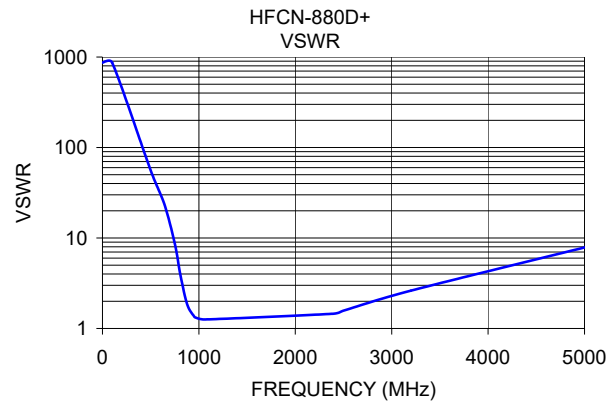
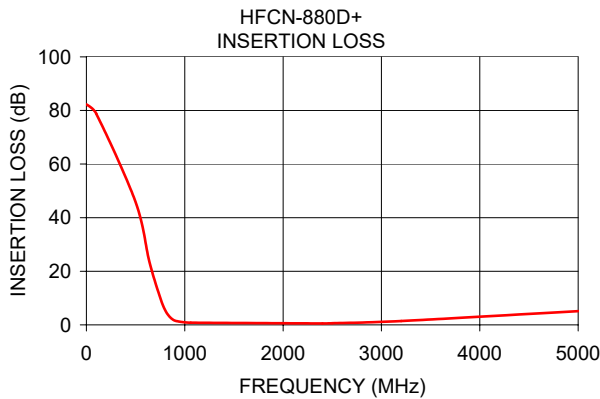

NOTES

- A. Performance and quality attributes and conditions not expressly stated in this specification document are intended to be excluded and do not form a part of this specification document.
- B. Electrical specifications and performance data contained in this specification document are based on Mini-Circuit's applicable established test performance criteria and measurement instructions.
- C. The parts covered by this specification document are subject to Mini-Circuits standard limited warranty and terms and conditions (collectively, "Standard Terms"); Purchasers of this part are entitled to the rights and benefits contained therein. For a full statement of the standard. Terms and the exclusive rights and remedies thereunder, please visit Mini-Circuits' website at www.minicircuits.com/MCLStore/terms.jsp

